

Operating Instructions Functional Manual

LCD Projector Commercial Use

Model No. **PT-MZ880**
PT-MZ780
PT-MZ680

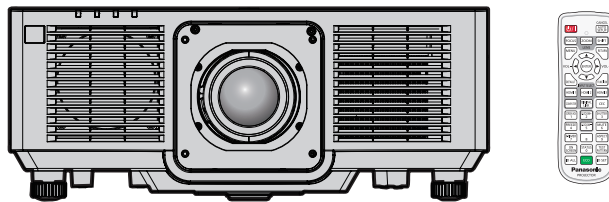

Thank you for purchasing this Panasonic product.

- This manual is common to all the models regardless of suffixes of the Model No.
 - for India
BD: Black model WD: White model
 - for Taiwan
BT: Black model WT: White model
 - for other countries or regions
B: Black model W: White model
- Before operating this product, please read the instructions carefully and save this manual for future use.
- Before using this product, be sure to read “Read this first!” (➔ pages 5 to 19).



Contents

Read this first!..... 5

Chapter 1 Preparation

Precautions for use..... 23	
Intended use of the product..... 23	
Lens protection material..... 23	
Cautions when transporting..... 23	
Cautions when installing..... 23	
Security..... 25	
DIGITAL LINK..... 26	
Art-Net..... 26	
Application software supported by the projector..... 26	
Storing..... 26	
Disposal..... 27	
Cautions on use..... 27	
Accessories..... 28	
Optional accessories..... 29	
About your projector..... 30	
Remote control..... 30	
Projector body..... 31	
Preparing the remote control..... 34	
Inserting and removing the batteries..... 34	
When using the multiple projectors..... 34	
Connecting the remote control to the projector with a cable..... 34	

Chapter 2 Getting Started

Setting up..... 36	
Installation mode..... 36	
Parts for installation (optional)..... 37	
Projected image and throw distance..... 38	
Removing/attaching the projection lens..... 44	
Removing the projection lens..... 44	
Attaching the projection lens..... 45	
Connecting..... 46	
Before connecting..... 46	
Connecting example: AV equipment..... 46	
Connecting example: Computers..... 47	
Connecting example using DIGITAL LINK..... 48	
Connecting example when using the contrast synchronization function/shutter synchronization function..... 49	

Chapter 3 Basic Operations

Switching on/off the projector..... 52	
Connecting the power cord..... 52	
Power indicator..... 53	

Switching on the projector..... 54	
When the initial setting screen is displayed..... 55	
When the administrator account setting screen is displayed..... 58	
Making adjustments and selections..... 60	
Switching off the projector..... 61	
Projecting..... 62	
Selecting the input signal..... 62	
Adjusting the focus, zoom, and lens shift..... 63	
Setting the lens type..... 64	
Moving the lens position to the home position..... 64	
Lens shift range..... 65	
Adjusting adjustable feet..... 65	
Operating with the remote control..... 66	
Using the shutter function..... 66	
Using the mute function..... 66	
Adjusting the volume..... 67	
Using the freeze function..... 67	
Using the on-screen display function..... 67	
Using the automatic setup function..... 68	
Using the screen adjustment function..... 68	
Using the digital zoom function..... 69	
Switching the image aspect ratio..... 70	
Using the presentation timer function..... 70	
Using the function button..... 70	
Displaying internal test pattern..... 70	
Using the status function..... 71	
Using the ECO management function..... 71	
Using the HDMI-CEC function..... 71	
Setting ID number of the remote control..... 72	

Chapter 4 Settings

Menu navigation..... 74	
Navigating through the menu..... 74	
Main menu..... 76	
Sub-menu..... 76	
[PICTURE] menu..... 79	
[PICTURE MODE]..... 79	
[CONTRAST]..... 79	
[BRIGHTNESS]..... 79	
[COLOR]..... 80	
[TINT]..... 80	
[COLOR TEMPERATURE]..... 80	
[GAMMA]..... 81	
[DAYLIGHT VIEW]..... 82	
[SHARPNESS]..... 82	
[NOISE REDUCTION]..... 82	
[DYNAMIC CONTRAST]..... 83	
[SYSTEM SELECTOR]..... 83	

Contents

[POSITION] menu	85	[SAVE ALL USER DATA].....	125
[SHIFT].....	85	[LOAD ALL USER DATA].....	125
[ASPECT].....	85	[HDMI CEC].....	126
[ZOOM].....	86	[INITIALIZE].....	128
[CLOCK PHASE].....	87	[SERVICE PASSWORD].....	128
[REALTIME KEYSTONE].....	87	[TEST PATTERN] menu	129
[SCREEN ADJUSTMENT].....	88	[TEST PATTERN].....	129
[ADVANCED MENU] menu	91	[SIGNAL LIST] menu	130
[DIGITAL CINEMA REALITY].....	91	Registering new signals.....	130
[BLANKING].....	91	Renaming the registered signal.....	130
[INPUT RESOLUTION].....	92	Deleting the registered signal.....	130
[EDGE BLENDING].....	92	Protecting the registered signal.....	131
[CLAMP POSITION].....	94	Expanding signal lock-in range.....	131
[RASTER POSITION].....	94	Sub memory.....	132
[DISPLAY LANGUAGE] menu	95	[SECURITY] menu	133
Changing the display language.....	95	[SECURITY PASSWORD].....	133
[DISPLAY OPTION] menu	96	[SECURITY PASSWORD CHANGE].....	133
[COLOR ADJUSTMENT].....	96	[DISPLAY SETTING].....	133
[COLOR CORRECTION].....	96	[TEXT CHANGE].....	134
[SCREEN SETTING].....	97	[MENU LOCK].....	134
[AUTO SIGNAL].....	97	[MENU LOCK PASSWORD].....	134
[AUTO SETUP].....	97	[CONTROL DEVICE SETUP].....	135
[COMPUTER IN].....	98	[CONTROL DEVICE PASSWORD CHANGE].....	136
[HDMI IN].....	99	[NETWORK] menu	137
[DIGITAL LINK IN].....	101	[ETHERNET TYPE].....	137
[ON-SCREEN DISPLAY].....	102	[DIGITAL LINK].....	137
[SIGNAL SEARCH].....	104	[WIRED LAN].....	139
[BACK COLOR].....	105	[PROJECTOR NAME].....	139
[STARTUP LOGO].....	105	[NETWORK STATUS].....	140
[UNIFORMITY].....	105	[ADMINISTRATOR ACCOUNT].....	140
[SHUTTER SETTING].....	107	[NETWORK SECURITY].....	142
[P-TIMER].....	108	[NETWORK CONTROL].....	143
[FREEZE].....	109	[PJLink].....	143
[DIGITAL ZOOM].....	109	[Art-Net].....	145
[PROJECTOR SETUP] menu	110		
[PROJECTOR ID].....	110		
[PROJECTION METHOD].....	110		
[ECO MANAGEMENT].....	111		
[INITIAL STARTUP].....	113		
[STARTUP INPUT SELECT].....	113		
[DATE AND TIME].....	114		
[SCHEDULE].....	115		
[MULTI PROJECTOR SYNC].....	116		
[RS-232C].....	118		
[REMOTE2 MODE].....	120		
[FUNCTION BUTTON].....	120		
[LENS].....	120		
[AUDIO SETTING].....	121		
[FILTER COUNTER].....	123		
[DC OUT].....	124		
[STATUS].....	124		
[DATA CLONING].....	125		

Chapter 5 Operations

Network connection	148
Connecting via wired LAN.....	148
Web control function	151
Computer that can be used for setting.....	151
Accessing from the web browser.....	151
Using the data cloning function	165
Copying the data to other projector via LAN.....	165
Using HDMI-CEC function	167
Connecting a CEC-compatible device.....	167
Setting the projector and CEC-compatible device.....	167
Operating the CEC-compatible device with the projector remote control.....	167
About the link control	168
Updating the firmware	169
Updating the firmware via LAN.....	169

Chapter 6 Maintenance

Light source/temperature/filter indicators.....175
 When an indicator lights up.....175
Maintenance/replacement.....177
 Before performing maintenance/replacement.....177
 Maintenance.....177
 Replacing the unit.....179
Troubleshooting.....181
[SELF TEST] display.....183

Chapter 7 Appendix

Technical information.....186
 Using the PJLink function.....186
 Using Art-Net function.....187
 Control commands via LAN.....191
 <SERIAL/MULTI SYNC IN> / <MULTI SYNC
 OUT> terminals.....194
 <REMOTE 2 IN> terminal.....198
 <COMPUTER IN> terminal pin assignment and
 signal name.....199
 <MONITOR OUT> terminal pin assignment and
 signal name.....199
Specifications.....200
 Dimensions.....203
 Precautions for attaching the Ceiling Mount
 Bracket.....203
 List of compatible signals.....205
 List of plug and play compatible signals.....206
Index.....208

Read this first!

WARNING: THIS APPARATUS MUST BE EARTHED.

WARNING: To prevent damage which may result in fire or shock hazard, do not expose this appliance to rain or moisture.
This device is not intended for use in the direct field of view at visual display workplaces. To avoid incommoding reflexions at visual display workplaces this device must not be placed in the direct field of view.
The equipment is not intended for used at a video workstation in compliance BildscharbV.

The sound pressure level at the operator position is equal or less than 70 dB (A) according to ISO 7779.

WARNING:

1. Remove the plug from the mains socket when this unit is not in use for a prolonged period of time.
2. To prevent electric shock, do not remove cover. No user serviceable parts inside. Refer servicing to qualified service personnel.
3. Do not remove the earthing pin on the mains plug. This apparatus is equipped with a three prong earthing-type mains plug. This plug will only fit an earthing-type mains socket. This is a safety feature. If you are unable to insert the plug into the mains socket, contact an electrician. Do not defeat the purpose of the earthing plug.

WARNING:

This equipment is compliant with Class A of CISPR32.
In a residential environment this equipment may cause radio interference.

(for Taiwan)

WARNING:

This equipment complies with the Class A standard of CNS13438.
This is Class A information technology equipment that may cause radio frequency interference when used in a residential environment, in which the user will be required to take certain appropriate countermeasures.

CAUTION: To assure continued compliance, follow the attached installation instructions. This includes using the provided power cord and shielded interface cables when connecting to computer or peripheral devices. Also, any unauthorized changes or modifications to this equipment could void the user's authority to operate this device.

This is a device to project images onto a screen, etc., and is not intended for use as indoor lighting in a domestic environment.

Directive 2009/125/EC

WARNING: TO REDUCE THE RISK OF FIRE OR ELECTRIC SHOCK, DO NOT EXPOSE THIS PRODUCT TO RAIN OR MOISTURE.

WARNING: RISK OF ELECTRIC SHOCK. DON'T OPEN.

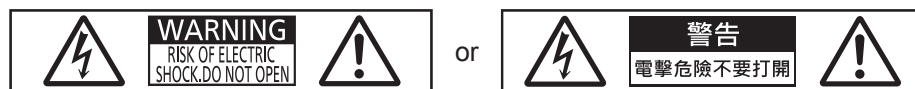

Indicated on the projector



The lightning flash with arrowhead symbol, within an equilateral triangle, is intended to alert the user to the presence of uninsulated "dangerous voltage" within the product's enclosure that may be of sufficient magnitude to constitute a risk of electric shock to persons.



The exclamation point within an equilateral triangle is intended to alert the user to the presence of important operating and maintenance (servicing) instructions in the literature accompanying the product.

Read this first!

WARNING: Do not look at the light emitted from the lens while the projector is being used.
As with any bright source, do not stare into the direct beam, RG2 IEC 62471-5:2015.



RG2

Indicated on the projector

**Notice on laser
(for USA and Canada)**

This projector is the Class 3R laser product that complies with IEC 60825-1:2007.

**FOR NORTH AMERICA:
LASER APERTURE
OUVERTURE LASER**
DPQT1601ZA

For North America
Complies with 21 CFR Parts 1040.10 and 1040.11
except for deviations pursuant to Laser Notice
No.50 dated June 24,2007
IEC 60825-1:2007
LASER RADIATION
AVOID DIRECT EYE EXPOSURE
CLASS 3R LASER PRODUCT
WAVE LENGTH:450-460nm
MAXIMUM OUTPUT:333mW
IEC 60825-1:2007
RAYONNEMENT LASER
EXPOSITION DIRECTE DANGEREUSE POUR LES YEUX
APPAREIL A LASER DE CLASSE 3R
LONGUEURS D' ONDES:450-460nm
MAXIMALE DU RAYONNEMENT:333mW

**注意—打开时有 4 类激光辐射
避免眼或皮肤受到直射或散射辐射的照射
危険-開放時クラス 4 のレーザー放射
直接放射又は分散放射に眼又は皮膚を暴露させないこと
DANGER-CLASS 4 LASER RADIATION WHEN OPEN AVOID EYE OR
SKIN EXPOSURE TO DIRECT OR SCATTERED RADIATION
DANGER-RAYONNEMENT LASER DE CLASSE 4 - EN CAS D'OUVERTURE
EXPOSITION DANGEREUSE AU RAYONNEMENT DIRECT OU
DIFFUS DES YEUX OU DE LA PEAU**
DPQT1359ZA

**注意-開放時クラス 2 のレーザー放射
直接放射又は分散放射に眼又は皮膚を暴露させないこと
CAUTION-CLASS 2 LASER RADIATION WHEN OPEN AVOID EYE OR
SKIN EXPOSURE TO DIRECT OR SCATTERED RADIATION
CAUTION-RAYONNEMENT LASER DE CLASSE 2 - EN CAS D'OUVERTURE
EXPOSITION DANGEREUSE AU RAYONNEMENT DIRECT OU
DIFFUS DES YEUX OU DE LA PEAU**
DPQT1303ZA

RG2

(Inside of product)

Indicated on the projector

(for India)

This projector is the Class 1 laser product that complies with IEC/EN 60825-1:2014.

CLASS 1 LASER PRODUCT

RG2

Read this first!

(for Taiwan)

This projector is the Class 1 laser product that complies with IEC/EN 60825-1:2014.

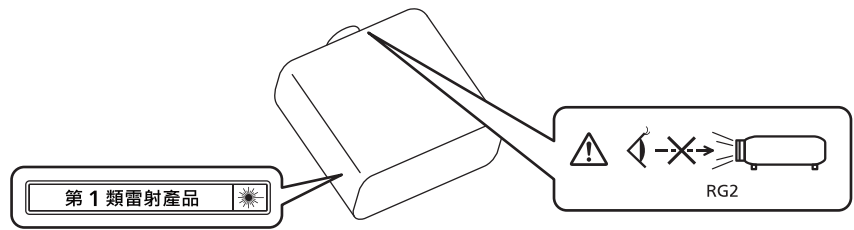

(for other countries or regions)

This projector is the Class 1 laser product that complies with IEC/EN 60825-1:2014.

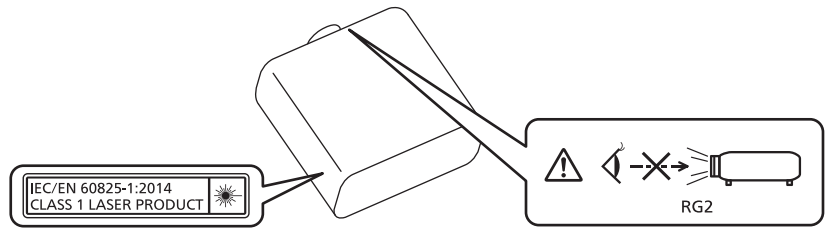

CAUTION: Use of controls or adjustments or performance of procedures other than those specified herein may result in hazardous radiation exposure.

CAUTION (North/Middle/South America)

Power Supply: This Projector is designed to operate on 100 V - 240 V, 50 Hz/60 Hz AC, house current only.

CAUTION: The AC power cord which is supplied with the projector as an accessory can only be used for power supplies up to 125 V. If you need to use higher voltages than this, you will need to obtain a separate 250 V power cord. If you use the accessory cord in such situations, fire may result.

CAUTION (North/Middle/South America/Taiwan)

This equipment is equipped with a three-pin grounding-type power plug. Do not remove the grounding pin on the power plug. This plug will only fit a grounding-type power outlet. This is a safety feature. If you are unable to insert the plug into the outlet, contact an electrician. Do not defeat the purpose of the grounding plug.

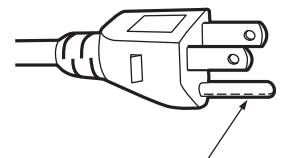

Do not remove

WARNING (USA and Canada)

- Not for use in a computer room as defined in the Standard for the Protection of Electronic Computer/Data Processing Equipment, ANSI/NFPA 75.
- For permanently connected equipment, a readily accessible disconnect device shall be incorporated in the building installation wiring.
- For pluggable equipment, the socket-outlet shall be installed near the equipment and shall be easily accessible.

NOTIFICATION (Canada)

This class A digital apparatus complies with Canadian ICES-003.

For USA-California Only

This product contains a CR Coin Cell Lithium Battery which contains Perchlorate Material – special handling may apply.

See www.dtsc.ca.gov/hazardouswaste/perchlorate

For Australia Only

WARNING: THIS PRODUCT CONTAINS A COIN BATTERY



Keep coin battery out of the reach of infants and small children whether the battery is new or used. Severe or fatal injuries can occur within 2 hours of ingestion. Seek medical attention immediately.



FCC NOTICE (USA)

Supplier's Declaration of Conformity

Model Number: PT-MZ880W / PT-MZ880B / PT-MZ780W / PT-MZ780B / PT-MZ680W / PT-MZ680B

Trade Name: Panasonic

Responsible Party: Panasonic Corporation of North America

Address: Two Riverfront Plaza, Newark, NJ 07102-5490

General Contact: <http://www.panasonic.com/support>

Projector Contact: <https://panasonic.net/cns/projector/>

This device complies with Part 15 of the FCC Rules.

Operation is subject to the following two conditions:

(1) This device may not cause harmful interference, and (2) this device must accept any interference received, including interference that may cause undesired operation.

Caution:

This equipment has been tested and found to comply with the limits for a Class A digital device, pursuant to part 15 of the FCC Rules. These limits are designed to provide reasonable protection against harmful interference when the equipment is operated in a commercial environment. This equipment generates, uses, and can radiate radio frequency energy and, if not installed and used in accordance with the instruction manual, may cause harmful interference to radio communications. Operation of this equipment in a residential area is likely to cause harmful interference in which case the user will be required to correct the interference at his own expense.

FCC Warning:

To assure continued compliance, follow the attached installation instructions. This includes using the provided power cord and shielded interface cables when connecting to computer or peripheral devices. Also, any unauthorized changes or modifications to this equipment could void the user's authority to operate this device.

IMPORTANT: THE MOLDED PLUG

FOR YOUR SAFETY, PLEASE READ THE FOLLOWING TEXT CAREFULLY.

This appliance is supplied with a molded three pin mains plug for your safety and convenience. A 13 amp fuse is fitted in this plug. Should the fuse need to be replaced, please ensure that the replacement fuse has a rating of 13 amps and that it is approved by ASTA or BSI to BS1362.

Check for the ASTA mark  or the BSI mark  on the body of the fuse.

If the plug contains a removable fuse cover, you must ensure that it is refitted when the fuse is replaced. If you lose the fuse cover, the plug must not be used until a replacement cover is obtained. A replacement fuse cover can be purchased from an Authorized Service Center.

If the fitted molded plug is unsuitable for the mains socket in your home, then the fuse should be removed and the plug cut off and disposed of safely. There is a danger of severe electrical shock if the cut off plug is inserted into any 13 amp socket.

If a new plug is to be fitted, please observe the wiring code as shown below.
If in any doubt, please consult a qualified electrician.

WARNING: THIS APPLIANCE MUST BE EARTHED.

IMPORTANT: The wires in this mains lead are colored in accordance with the following code:

Green - and - Yellow: Earth
Blue: Neutral
Brown: Live

As the colors of the wire in the mains lead of this appliance may not correspond with the colored markings identifying the terminals in your plug, proceed as follows.

The wire which is colored GREEN - AND - YELLOW must be connected to the terminal in the plug which is marked with the letter E or by the Earth symbol  or colored GREEN or GREEN - AND - YELLOW.

The wire which is colored BLUE must be connected to the terminal in the plug which is marked with the letter N or colored BLACK.

The wire which is colored BROWN must be connected to the terminal in the plug which is marked with the letter L or colored RED.

How to replace the fuse: Open the fuse compartment with a screwdriver and replace the fuse.

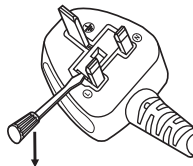

Read this first!

<p>English</p>	<p>Manufactured by: Panasonic Connect Co., Ltd. 4-1-62 Minoshima, Hakata-ku, Fukuoka 812-8531, Japan Importer: Panasonic Connect Europe GmbH Authorized Representative in EU: Panasonic Testing Centre Winsbergring 15, 22525 Hamburg, Germany</p> <p>Importer for UK: Panasonic Connect UK, a branch of Panasonic Connect Europe GmbH, Maxis 2, Western Road, Bracknell, Berkshire, RG12 1RT</p> 
<p>Français</p>	<p>Fabriqué par: Panasonic Connect Co., Ltd. 4-1-62 Minoshima, Hakata-ku, Fukuoka 812-8531, Japon Importateur: Panasonic Connect Europe GmbH Représentant autorisé dans l'UE: Panasonic Testing Centre Winsbergring 15, 22525 Hambourg, Allemagne</p>
<p>Español</p>	<p>Fabricado por: Panasonic Connect Co., Ltd. 4-1-62 Minoshima, Hakata-ku, Fukuoka 812-8531, Japón Importador: Panasonic Connect Europe GmbH Representante Autorizado para la UE: Panasonic Testing Centre Winsbergring 15, 22525 Hamburgo, Alemania</p>
<p>Deutsch</p>	<p>Hergestellt von: Panasonic Connect Co., Ltd. 4-1-62 Minoshima, Hakata-ku, Fukuoka 812-8531, Japan Importeur: Panasonic Connect Europe GmbH Vertretungsberechtigter in der EU: Panasonic Testing Centre Winsbergring 15, 22525 Hamburg, Deutschland</p>
<p>Italiano</p>	<p>Fabbricato da: Panasonic Connect Co., Ltd. 4-1-62 Minoshima, Hakata-ku, Fukuoka 812-8531, Giappone Importatore: Panasonic Connect Europe GmbH Rappresentante autorizzato nell'UE: Panasonic Testing Centre Winsbergring 15, 22525 Amburgo, Germania</p>

Read this first!

Български	<p>Производител: Panasonic Connect Co., Ltd. 4-1-62 Minoshima, Hakata-ku, Fukuoka 812-8531, Япония</p> <p>Вносител: Panasonic Connect Europe GmbH</p> <p>Упълномощен представител в ЕС: Panasonic Testing Centre Winsbergring 15, 22525 Hamburg, Германия</p>
Čeština	<p>Vyrobil: Panasonic Connect Co., Ltd. 4-1-62 Minoshima, Hakata-ku, Fukuoka 812-8531, Japonsko</p> <p>Dovozce: Panasonic Connect Europe GmbH</p> <p>Oprávněný zástupce v EU: Panasonic Testing Centre Winsbergring 15, 22525 Hamburg, Německo</p>
Dansk	<p>Fremstillet af: Panasonic Connect Co., Ltd. 4-1-62 Minoshima, Hakata-ku, Fukuoka 812-8531, Japan</p> <p>Importør: Panasonic Connect Europe GmbH</p> <p>Autoriseret repræsentant i EU: Panasonic Testing Centre Winsbergring 15, 22525 Hamburg, Tyskland</p>
Eesti	<p>Tootja: Panasonic Connect Co., Ltd. 4-1-62 Minoshima, Hakata-ku, Fukuoka 812-8531, Jaapan</p> <p>Maaletooja: Panasonic Connect Europe GmbH</p> <p>Volitatud esindaja ELis: Panasonic Testing Centre Winsbergring 15, 22525 Hamburg, Saksamaa</p>
Ελληνικά	<p>Κατασκευάστηκε από: Panasonic Connect Co., Ltd. 4-1-62 Minoshima, Hakata-ku, Fukuoka 812-8531, Ιαπωνία</p> <p>Εισαγωγέας: Panasonic Connect Europe GmbH</p> <p>Εξουσιοδοτημένος αντιπρόσωπος στην ΕΕ: Panasonic Testing Centre Winsbergring 15, 22525 Hamburg, Γερμανία</p>
Hrvatski	<p>Proizvodi: Panasonic Connect Co., Ltd. 4-1-62 Minoshima, Hakata-ku, Fukuoka 812-8531, Japan</p> <p>Uvoznik: Panasonic Connect Europe GmbH</p> <p>Onlaštteni zastupnik u EU-u: Panasonic Testing Centre Winsbergring 15, 22525 Hamburg, Njemačka</p>
Latviešu	<p>Ražotājs: Panasonic Connect Co., Ltd. 4-1-62 Minoshima, Hakata-ku, Fukuoka 812-8531, Japāna</p> <p>Importētājs: Panasonic Connect Europe GmbH</p> <p>Oficiālais pārstāvis ES: Panasonic Testing Centre Winsbergring 15, 22525 Hamburg, Vācija</p>
Lietuvių	<p>Gamintojas: Panasonic Connect Co., Ltd. 4-1-62 Minoshima, Hakata-ku, Fukuoka 812-8531, Japonija</p> <p>Importuotojas: Panasonic Connect Europe GmbH</p> <p>Igaliotasis atstovas ES: Panasonic Testing Centre Winsbergring 15, 22525 Hamburgas, Vokietija</p>
Magyar	<p>Gyártotta: Panasonic Connect Co., Ltd. 4-1-62 Minoshima, Hakata-ku, Fukuoka 812-8531, Japán</p> <p>Importőr: Panasonic Connect Europe GmbH</p> <p>Hivatalos képviselő az EU-ban: Panasonic Testing Centre Winsbergring 15, 22525 Hamburg, Németország</p>
Nederlands	<p>Geproduceerd door: Panasonic Connect Co., Ltd. 4-1-62 Minoshima, Hakata-ku, Fukuoka 812-8531, Japan</p> <p>Importeur: Panasonic Connect Europe GmbH</p> <p>Bevoegde vertegenwoordiger in de EU: Panasonic Testing Centre Winsbergring 15, 22525 Hamburg, Duitsland</p>

Read this first!

Norsk	<p>Produsert av: Panasonic Connect Co., Ltd. 4-1-62 Minoshima, Hakata-ku, Fukuoka 812-8531, Japan</p> <p>Importør: Panasonic Connect Europe GmbH</p> <p>Autorisert representant i EU: Panasonic Testing Centre Winsbergring 15, 22525 Hamburg, Tyskland</p>
Polski	<p>Wyprodukowano przez: Panasonic Connect Co., Ltd. 4-1-62 Minoshima, Hakata-ku, Fukuoka 812-8531, Japonia</p> <p>Importer: Panasonic Connect Europe GmbH</p> <p>Upoważniony przedstawiciel w UE: Panasonic Testing Centre Winsbergring 15, 22525 Hamburg, Niemcy</p>
Português	<p>Fabricado por: Panasonic Connect Co., Ltd. 4-1-62 Minoshima, Hakata-ku, Fukuoka 812-8531, Japão</p> <p>Importador: Panasonic Connect Europe GmbH</p> <p>Representante Autorizado na UE: Panasonic Testing Centre Winsbergring 15, 22525 Hamburgo, Alemanha</p>
Română	<p>Fabricat de: Panasonic Connect Co., Ltd. 4-1-62 Minoshima, Hakata-ku, Fukuoka 812-8531, Japonia</p> <p>Importator: Panasonic Connect Europe GmbH</p> <p>Reprezentant autorizat în UE: Panasonic Testing Centre Winsbergring 15, 22525 Hamburg, Germania</p>
Slovenčina	<p>Výrobca: Panasonic Connect Co., Ltd. 4-1-62 Minoshima, Hakata-ku, Fukuoka 812-8531, Japonsko</p> <p>Dovozca: Panasonic Connect Europe GmbH</p> <p>Autorizovaný zástupca v EÚ: Panasonic Testing Centre Winsbergring 15, 22525 Hamburg, Nemecko</p>
Slovenščina	<p>Proizvajaja: Panasonic Connect Co., Ltd. 4-1-62 Minoshima, Hakata-ku, Fukuoka 812-8531, Japonska</p> <p>Uvoznik: Panasonic Connect Europe GmbH</p> <p>Pooblaščeni zastopnik v EU: Panasonic Testing Centre Winsbergring 15, 22525 Hamburg, Nemčija</p>
Suomi	<p>Valmistaja: Panasonic Connect Co., Ltd. 4-1-62 Minoshima, Hakata-ku, Fukuoka 812-8531, Japani</p> <p>Maahantuoja: Panasonic Connect Europe GmbH</p> <p>Valtuutettu edustaja EU:ssa: Panasonic Testing Centre Winsbergring 15, 22525 Hampuri, Saksa</p>
Svenska	<p>Tillverkad av: Panasonic Connect Co., Ltd. 4-1-62 Minoshima, Hakata-ku, Fukuoka 812-8531, Japan</p> <p>Importör: Panasonic Connect Europe GmbH</p> <p>Auktoriserad representant i EU: Panasonic Testing Centre Winsbergring 15, 22525 Hamburg, Tyskland</p>
Türkçe	<p>Tarafından Üretilmiştir: Panasonic Connect Co., Ltd. 4-1-62 Minoshima, Hakata-ku, Fukuoka 812-8531, Japonya</p> <p>İthalatçı: Panasonic Connect Europe GmbH</p> <p>AB Yetkili Temsilcisi: Panasonic Testing Centre Winsbergring 15, 22525 Hamburg, Almanya</p>

■ Hazard distance (IEC 62471-5:2015)

The distance from the projection lens surface, at which the emission reaches the Accessible Emission Limit (AEL) of risk group 2, is known as the hazard distance (HD) or safety distance. The area where the emission exceeds the Accessible Emission Limit of risk group 2 is called the hazard zone (HZ).

Within the hazard zone, never look into the light projected from the projector. The eyes may be damaged by direct irradiation even if you look at the light just for a moment. If you are outside the hazard zone, it is considered to be safe in all circumstances except deliberately staring into the light projected from the projector.

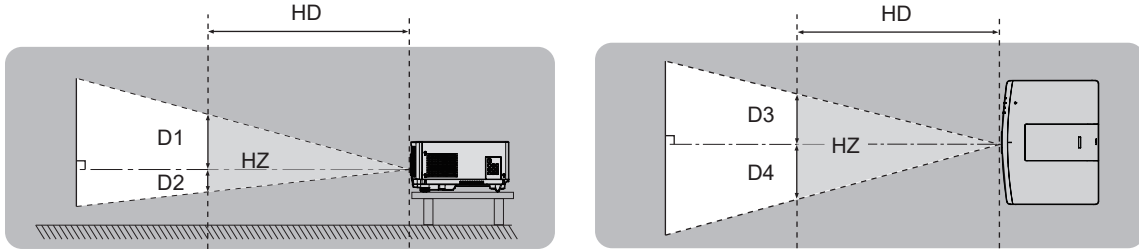

■ Risk group

The combination of the projector and the projection lens is categorized as risk group 2 when the hazard distance is 1 m (39-3/8") or less. It is categorized as risk group 3 when the hazard distance exceeds 1 m (39-3/8"), and it will be for professional use instead of consumer use.

In case of risk group 3, there is a possibility of damaging the eyes by direct irradiation when looking into the projection light from inside the hazard zone even for a moment.

In the case of risk group 2, safe use without damaging the eyes is possible in all circumstances except deliberately staring into the light projected from the projector.

The combination of the projector and the projection lens which the hazard distance exceeds 1 m (39-3/8") and is categorized as risk group 3 is as follows.

Model No.	Projection lens Model No.	Risk group
PT-MZ880	ET-ELT23	Risk group 3
PT-MZ780		
PT-MZ680		

THIS PROJECTOR MAY BECOME RG3 FOR PROFESSIONAL USE ONLY AND ARE NOT INTENDED FOR CONSUMER USE WITH INTERCHANGEABLE PROJECTION LENS ET-ELT23. REFER TO THE OPERATING INSTRUCTIONS FOR HAZARD DISTANCE BEFORE OPERATION.

本投影機使用可換式投影鏡頭ET-ELT23時，屬於僅適合專業使用的RG3級產品，不能用作消費類電子產品。操作前請先參閱使用說明書了解危險距離。

DPQT1605ZA

For Taiwan

THIS PROJECTOR MAY BECOME RG3 FOR PROFESSIONAL USE ONLY AND ARE NOT INTENDED FOR CONSUMER USE WITH INTERCHANGEABLE PROJECTION LENS ET-ELT23. REFER TO THE OPERATING INSTRUCTIONS FOR HAZARD DISTANCE BEFORE OPERATION.

CE PROJECTEUR PEUT DEVENIR RG3 POUR UNE UTILISATION PROFESSIONNELLE UNIQUEMENT ET N'EST PAS DESTINÉ À UNE UTILISATION DOMESTIQUE AVEC L'OBJECTIF DE PROJECTION INTERCHANGEABLE ET-ELT23. CONSULTEZ LE MANUEL D'UTILISATION ET PRENEZ CONNAISSANCE DE LA DISTANCE DU RISQUE AVANT DE L'UTILISER.

이 프로젝터는 투사 렌즈 ET-ELT23과 함께 사용하는 경우, 전문가 전용인 RG3 등급으로 되어, 일반 소비자용이 아닙니다. 작동하기 전에 위험 거리에 대해서는 사용 설명서를 참조하십시오.

DIESER PROJEKTOR KANN AUSSCHLIESSLICH FÜR DIE PROFESSIONELLE VERWENDUNG ALS RG3 EINGESTUFT WERDEN UND IST MIT DEM AUSTAUSCHPROJEKTIONSOBJEKTIV ET-ELT23 NICHT FÜR DIE VERWENDUNG DURCH VERBRAUCHER KONZIPIERT. BEACHTEN SIE VOR DER BEDIENUNG DIE BEDIENUNGSANLEITUNG IN BEZUG AUF DEN GEFÄHRDUNGSABSTAND.

ДАННЫЙ ПРОЕКТОР МОЖЕТ ВХОДИТЬ В ГРУППУ РИСКА RG3 – ТОЛЬКО ДЛЯ ПРОФЕССИОНАЛЬНОГО ИСПОЛЬЗОВАНИЯ, И ОН НЕ ПРЕДНАЗНАЧЕН ДЛЯ ИСПОЛЬЗОВАНИЯ ПОТРЕБИТЕЛЯМИ СО СМЕННЫМ ПРОЕКЦИОННЫМ ОБЪЕКТИВОМ ET-ELT23. ПЕРЕД НАЧАЛОМ РАБОТЫ ОБРАТИТЕСЬ К ИНСТРУКЦИИ ПО ЭКСПЛУАТАЦИИ, ЧТОБЫ УЗНАТЬ ПРО ОПАСНОЕ РАССТОЯНИЕ.

DPQT1599ZA

For other countries and regions

Each dimension inside the hazard zone for combination with projection lens which the hazard distance exceeds 1 m (39-3/8") is as follows.

(Unit: m)

Model No.	Projection lens Model No.	HD ^{*1}	D1 ^{*2}	D2 ^{*2}	D3 ^{*2}	D4 ^{*2}
PT-MZ880	ET-ELT23	1.9	0.09	0.09	0.15	0.15
PT-MZ780						
PT-MZ680						

*1 HD: Hazard Distance

*2 The values of D1 to D4 will change in accordance with the lens shift amount. Each value in the table is the maximum value.

Read this first!

Note

- The values in the table comply with IEC 62471-5:2015.
- Projection lens compatible with the projector may be added or changed without prior notice.
For the latest information, visit the website (<https://panasonic.net/cns/projector/>).

Attention

- If the light projected from the projector directly enters the eyes while you are inside the hazard zone, the retinas may be damaged. Do not enter the hazard zone during use. Alternatively, install the projector in a location where the projected light will not directly enter the eyes.

WARNING:

■ POWER

The wall outlet or the circuit breaker shall be installed near the equipment and shall be easily accessible when problems occur. If the following problems occur, cut off the power supply immediately.

Continued use of the projector in these conditions will result in fire or electric shock, or will cause visual impairment.

- If foreign objects or water get inside the projector, cut off the power supply.
- If the projector is dropped or the cabinet is broken, cut off the power supply.
- If you notice smoke, strange smells or noise coming from the projector, cut off the power supply.

Please contact an Authorized Service Center for repairs, and do not attempt to repair the projector yourself.

During a thunderstorm, do not touch the projector or the cable.

Electric shocks can result.

Do not do anything that might damage the power cord or the power plug.

If the power cord is used while damaged, electric shocks, short-circuits or fire will result.

- Do not damage the power cord, make any modifications to it, place it near any hot objects, bend it excessively, twist it, pull it, place heavy objects on top of it or wrap it into a bundle.

Ask an Authorized Service Center to carry out any repairs to the power cord that might be necessary.

Do not use anything other than the provided power cord.

Failure to observe this will result in electric shocks or fire. Please note that if you do not use the provided power cord to ground the device on the side of the outlet, this may result in electric shocks.

Completely insert the power plug into the wall outlet and the power connector into the projector terminal.

If the plug is not inserted correctly, electric shocks or overheating will result.

- Do not use plugs which are damaged or wall outlets which are coming loose from the wall.

Do not handle the power plug and power connector with wet hands.

Failure to observe this will result in electric shocks.

Do not overload the wall outlet.

If the power supply is overloaded (ex., by using too many adapters), overheating may occur and fire will result.

Clean the power plug regularly to prevent it from becoming covered in dust.

Failure to observe this will cause a fire.

- If dust builds up on the power plug, the resulting humidity can damage the insulation.
- If not using the projector for an extended period of time, pull the power plug out from the wall outlet.

Pull the power plug out from the wall outlet and wipe it with a dry cloth regularly.

■ ON USE/INSTALLATION

Do not place the projector on soft materials such as carpets or sponge mats.

Doing so will cause the projector to overheat, which can cause burns, fire or damage to the projector.

Do not set up the projector in humid or dusty places or in places where the projector may come into contact with oily smoke or steam.

Using the projector under such conditions will result in fire, electric shocks or deterioration of components. Oil may also distort the plastic and the projector could fall such as when mounted on the ceiling.

Do not install this projector in a place which is not strong enough to take the full weight of the projector or on top of a surface which is sloped or unstable.

Failure to observe this will cause projector to fall down or tip over the projector, and severe injury or damage could result.

Do not install the projector in a location where people pass through.

People may bump into the projector or trip on the power cord, which may result in fire, electric shock, or injury.

Do not cover the intake/exhaust vents.

Doing so will cause the projector to overheat, which can cause fire or damage to the projector.

- Do not place the projector in narrow, badly ventilated places.
- Do not place the projector on cloth or papers, as these materials could be drawn into the intake vent.
- Provide at least 1 m (39-3/8") of space between any walls or objects and the exhaust vent, and at least 50 cm (19-11/16") of space between any walls or objects and the intake vent.

WARNING:

Do not look at or place your skin into the light emitted from the lens while the projector is being used. Do not enter the projection luminous flux using an optical device (such as magnifier or mirror).

Doing so can cause burns or loss of sight.

- Strong light is emitted from the projector's lens. Do not look at or place your hands directly into this light.
- Be especially careful not to let young children look into the lens. In addition, turn off the power and disconnect the power plug when you are away from the projector.

Do not project an image with the lens cover attached.

Doing so can cause fire.

Never attempt to remodel or disassemble the projector.

High voltages can cause fire or electric shocks.

- For any inspection, adjustment and repair work, please contact an Authorized Service Center.

Do not allow metal objects, flammable objects, or liquids to enter inside of the projector. Do not allow the projector to get wet.

Doing so may cause short circuits or overheating, and result in fire, electric shock, or malfunction of the projector.

- Do not place containers of liquid or metal objects near the projector.
- If liquid enters inside of the projector, consult your dealer.
- Particular attention must be paid to children.

Use the ceiling mount bracket specified by Panasonic Connect Co., Ltd.

Using the ceiling mount bracket other than the specified one will result in falling accidents.

- Attach the supplied safety cable to the ceiling mount bracket to prevent the projector from falling down.

Installation work such as mounting the projector on the ceiling should only be carried out by a qualified technician.

If installation is not carried out and secured correctly, it can cause injury or accidents, such as electric shocks.

■ ACCESSORIES

Do not use or handle the batteries improperly, and refer to the following.

Failure to observe this will cause burns, batteries to leak, overheat, explode or catch fire.

- Do not use unspecified batteries.
- Do not charge dry cell batteries.
- Do not disassemble dry cell batteries.
- Do not heat the batteries or place them into water or fire.
- Do not allow the + and – terminals of the batteries to come into contact with metallic objects such as necklaces or hairpins.
- Do not store or carry batteries together with metallic objects.
- Store the batteries in a plastic bag and keep them away from metallic objects.
- Make sure the polarities (+ and –) are correct when inserting the batteries.
- Do not use a new battery together with an old battery or mix different types of batteries.
- Do not use batteries with the outer cover peeling away or removed.

If the battery fluid leaks, do not touch it with bare hands, and take the following measures if necessary.

- Battery fluid on your skin or clothing could result in skin inflammation or injury.
Rinse with clean water and seek medical advice immediately.
- Battery fluid coming in contact with your eyes could result in loss of sight.
In this case, do not rub your eyes. Rinse with clean water and seek medical advice immediately.

Do not allow children to reach the batteries.

Accidentally swallowing them can cause physical harm.

- If swallowed, seek medical advice immediately.

Remove the depleted batteries from the remote control promptly.

- Leaving them in the unit may result in fluid leakage, overheating, or explosion of the batteries.

CAUTION:

■ **POWER**

When disconnecting the power cord, be sure to hold the power plug and power connector.

If the power cord itself is pulled, the lead will become damaged, and fire, short-circuits or serious electric shocks will result.

When not using the projector for an extended period of time, disconnect the power plug from the wall outlet.

Failure to do so may result in fire or electric shock.

Before replacing the projection lens, be sure to turn off the power and disconnect the power plug from the wall outlet.

- Unexpected projection of light may cause injury to eyes.
- Replacing the projection lens without removing the power plug may result in electric shock.

Disconnect the power plug from the wall outlet before carrying out any cleaning and replacing the unit.

Failure to do so may result in electric shock.

■ **ON USE/INSTALLATION**

Do not place heavy objects on top of the projector.

Failure to observe this will cause the projector to become unbalanced and fall, which could result in damage or injury. The projector will be damaged or deformed.

Do not put your weight on this projector.

You could fall or the projector could break, and injury will result.

- Be especially careful not to let young children stand or sit on the projector.

Do not place the projector in extremely hot locations.

Doing so will cause the outer casing or internal components to deteriorate, or result in fire.

- Take particular care in locations exposed to direct sunlight or near heaters.

Do not place your hands in the openings beside the optical lens, while shifting the lens.

Failure to observe this could cause injury.

Do not install the projector in a location where salt pollution or corrosive gas may occur.

Doing so may result in falling due to corrosion. Also, it may result in malfunctions.

Do not stand in front of the lens while the projector is being used.

Doing so can cause damage and burns to clothing.

- Strong light is emitted from the projector's lens.

Do not place objects in front of the lens while the projector is being used.

Do not block the projection by placing an object in front of the projection lens.

Doing so can cause fire, damage to an object, or malfunction of the projector.

- Strong light is emitted from the projector's lens.

Always disconnect all cables before moving the projector.

Moving the projector with cables still attached can damage the cables, which will cause fire or electric shocks to occur.

Never plug headphones and earphones into <AUDIO OUT> terminal.

Excessive sound pressure from headphones and earphones can cause hearing loss.

When mounting the projector on the ceiling, keep mounting screws and power cord from contact with metal parts inside the ceiling.

Contact with metal parts inside the ceiling can cause electric shocks.

CAUTION:

■ **ACCESSORIES**

When not using the projector for an extended period of time, remove the batteries from the remote control.

Failure to observe this will cause the batteries to leak, overheat, catch fire or explode, which may result in fire or contamination of surrounding area.

■ **MAINTENANCE**

Do not attach the air filter unit while it is wet.

Doing so may result in electric shock or malfunctions.

- After you clean the air filter units, dry them thoroughly before reattaching them.

Ask your dealer about cleaning inside the projector every 20 000 hours of usage as an estimated duration.

Continuous use while dust is accumulated inside the projector may result in fire.

- For cleaning fee, ask your dealer.

To remove the battery

Remote Control Battery

1. Press the guide and lift the cover.

2. Remove the batteries.

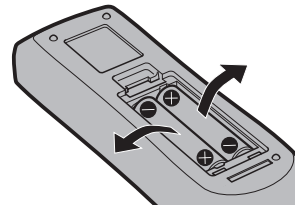
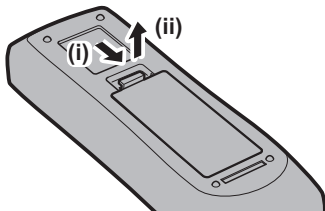

Brazil Only Brasil Apenas

■ Manuseio de baterias usadas

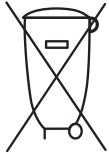

BRASIL

Após o uso, as pilhas e/ou baterias deverão ser entregues ao estabelecimento comercial ou rede de assistência técnica autorizada.

Cobrir os terminais positivo (+) e negativo (-) com uma fita isolante adesiva, antes de depositar numa caixa destinada para o recolhimento. O contato entre partes metálicas pode causar vazamentos, gerar calor, romper a blindagem e produzir fogo. (Fig. 1)

Fig. 1
Como isolar os terminais

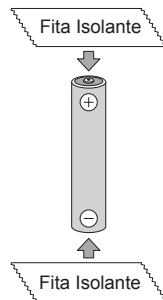

Não desmonte, não remova o invólucro, nem amasse a bateria. O gás liberado pela bateria pode irritar a garganta, danificar o lacre do invólucro ou o vazamento provocar calor, ruptura da blindagem e produzir fogo devido ao curto circuito dos terminais. Não incinere nem aqueça as baterias, elas não podem ficar expostas a temperaturas superiores a 100 °C (212 °F). O gás liberado pela bateria pode irritar a garganta, danificar o lacre do invólucro ou o vazamento provocar calor, ruptura da blindagem e produzir fogo devido ao curto circuito dos terminais provocado internamente.

Evite o contato com o líquido que vazar das baterias. Caso isto ocorra, lave bem a parte afetada com bastante água. Caso haja irritação, consulte um médico.

■ Remoção das baterias

1. Pressione a guia e levante a tampa.

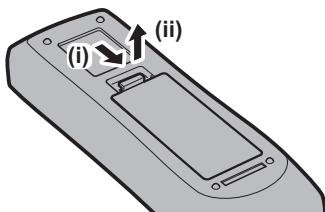

2. Remova as baterias.

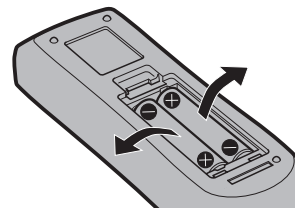

■ Trademarks

- SOLID SHINE is a trademark of Panasonic Holdings Corporation.
- Windows, Internet Explorer and Microsoft Edge are registered trademarks or trademarks of Microsoft Corporation in the United States and other countries.
- Mac, macOS, and Safari are trademarks of Apple Inc., registered in the United States and other countries.
- Trademark PJLink is a trademark applied for trademark rights in Japan, the United States of America and other countries and areas.
- The terms HDMI and HDMI High-Definition Multimedia Interface, and the HDMI Logo are trademarks or registered trademarks of HDMI Licensing Administrator, Inc. in the United States and other countries.
- Crestron Connected, the Crestron Connected logo, Crestron Fusion, Crestron RoomView, and RoomView are trademarks or registered trademarks of Crestron Electronics, Inc. in the United States and/or other countries.
- HDBaseT™ is a trademark of HDBaseT Alliance.
- Art-Net™ Designed by and Copyright Artistic Licence Holdings Ltd
- IOS is a trademark or registered trademark of Cisco in the U.S. and other countries and is used under license.
- Android and Google Chrome are trademarks of Google LLC.
- Adobe, Acrobat and Reader are either registered trademarks or trademarks of Adobe Systems Incorporated in the United States and/or other countries.
- Some of the fonts used in the on-screen menu are Ricoh bitmap fonts, which are manufactured and sold by Ricoh Company, Ltd.
- All other names, company names, and product names mentioned in this manual are trademarks or registered trademarks of their respective owners.

Please note that the ® and ™ symbols are not specified in this manual.

■ Illustrations in this manual

- Illustrations of the projector, menu screen (OSD), and other parts may vary from the actual product.
- Illustrations displayed on the computer screen may differ depending on the computer type and its operating system.
- Illustrations of the projector with the power cord attached are only examples. The shape of the supplied power cords varies depending on the country where you purchased the product.

■ Reference pages

- Reference pages in this manual are indicated as (➡ page 00).

■ Term

- In this manual, the “Wireless/wired remote control unit” accessory is referred to as “Remote control”.

Features of the Projector

High picture quality and rich color reproduction

- ▶ High luminance of 8000 lm^{*1*2} and rich color reproducibility are achieved by the new optical design; natural and true-to-life images are reproduced utilizing the original image processing technology.

*1 PT-MZ880: 8 000 lm
PT-MZ780: 7 000 lm
PT-MZ680: 6 000 lm

*2 When [PICTURE MODE] is set to [DYNAMIC] and [LIGHT POWER] is set to [NORMAL]

System flexibility and versatile space creation

- ▶ Low operating noise^{*1} allows you to concentrate on the content; wide shift range expands the installation flexibility, and the edge blending function realizes versatile space creation.

*1 When [LIGHT POWER] is set to [QUIET], the noise level is 27 dB for PT-MZ880, and 26 dB for PT-MZ780 and PT-MZ680.

Eco-friendly design

- ▶ Power consumption is lowered compared with the preceding PT-MZ770 series. In addition, up to 20,000 hours^{*1} long-term operation of the filter is achieved, reducing total cost of ownership (TCO) as well as waste.

*1 This is an estimated usage time until the brightness decreases to approximately half of that at the time of delivery when the projector is used with [LIGHT POWER] set to [NORMAL] and [DYNAMIC CONTRAST] set to [2], using IEC 62087:2008 Broadcast contents, and under the environment of dust 0.15 mg/m³ at 30 °C (86 °F) and an altitude of 700 m (2 297').

Quick Steps

For details, refer to the corresponding pages.

1. Set up the projector.
(⇒ page 36)



2. Connect with external devices.
(⇒ page 46)



3. Connect the power cord.
(⇒ page 52)



4. Switch on the projector.
(⇒ page 54)



5. Make initial settings.
(⇒ page 55)
 - Take this step when you switch on the power for the first time after purchasing the projector.



6. Select the input signal.
(⇒ page 62)



7. Adjust the image.
(⇒ page 63)

Chapter 1 Preparation

This chapter describes things you need to know or check before using the projector.

Precautions for use

Intended use of the product

The product is intended to project still/moving image signals from video equipment and computers onto a screen.

Lens protection material

Lens protection material is attached to the product at the time of purchase to protect the projection lens from the vibration during transport. Remove the lens protection material before use, and store it for the future use. Move the lens position to the home position and attach the lens protection material when transporting.

For the steps to move the lens position to the home position, refer to “Moving the lens position to the home position” (➔ page 64).

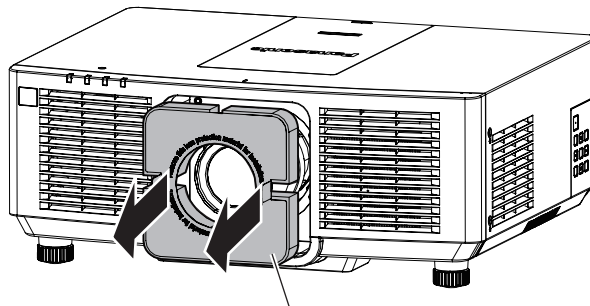

Lens protection material

Cautions when transporting

- When transporting the projector, hold it securely by its bottom and avoid excessive vibration and impacts. They may damage the internal components and result in malfunctions.
- Do not transport the projector with the adjustable feet extended. Doing so may damage the adjustable feet.

Cautions when installing

■ Do not set up the projector outdoors.

The projector is designed for indoor use only.

■ Do not set up the projector in the following locations.

- Places where vibration and impacts occur such as in a car or vehicle: Doing so may cause damage to internal components or malfunction.
- Location close to sea or where corrosive gas may occur: The projector may fall due to corrosion. Also, failure to do so may shorten the life of the components and result in malfunction.
- Near the exhaust of an air conditioner: Depending on the conditions of use, the screen may fluctuate in rare cases due to the heated air from the exhaust vent or the hot or cooled air from the air conditioner. Make sure that the exhaust from the projector or other equipment, or the air from the air conditioner does not blow toward the front of the projector.
- Places with sharp temperature fluctuations such as near lights (studio lamps): Doing so may shorten the life of the light source, or result in deformation of the projector due to heat, which may cause malfunctions. Follow the operating environment temperature of the projector.
- Near high-voltage power lines or near motors: Doing so may interfere with the operation of the projector.

■ Ask a qualified technician or your dealer for the installation work such as installing to a ceiling.

To ensure projector performance and safety, ask a qualified technician or your dealer when installing to a ceiling or in a high place.

■ **Ask a qualified technician or your dealer to install the cable wiring for DIGITAL LINK connection.**

Image and sound may be disrupted if cable transmission characteristics cannot be obtained due to inadequate installation.

■ **The projector may not work properly due to strong radio wave from the broadcast station or the radio.**

If there is any facility or equipment which outputs strong radio waves near the installation location, install the projector at a location sufficiently far from the source of the radio waves. Or, wrap the LAN cable connected to the <DIGITAL LINK/LAN> terminal using a piece of metal foil or a metal pipe which is grounded at both ends.

■ **Focus adjustment**

The high clarity projection lens is thermally affected by the light from the light source, making the focus unstable in the period just after switching on the power. It is recommended that images be projected continuously for at least 30 minutes before the focus is adjusted.

■ **Do not install the projector at an altitude of 2 700 m (8 858') or higher above sea level.**

■ **Do not use the projector in a location that the ambient temperature exceeds 45 °C (113 °F).**

Using the projector in a location that the altitude is too high or the ambient temperature is too high may reduce the life of the components or result in malfunctions.

■ **Projection in all 360° direction is possible.**

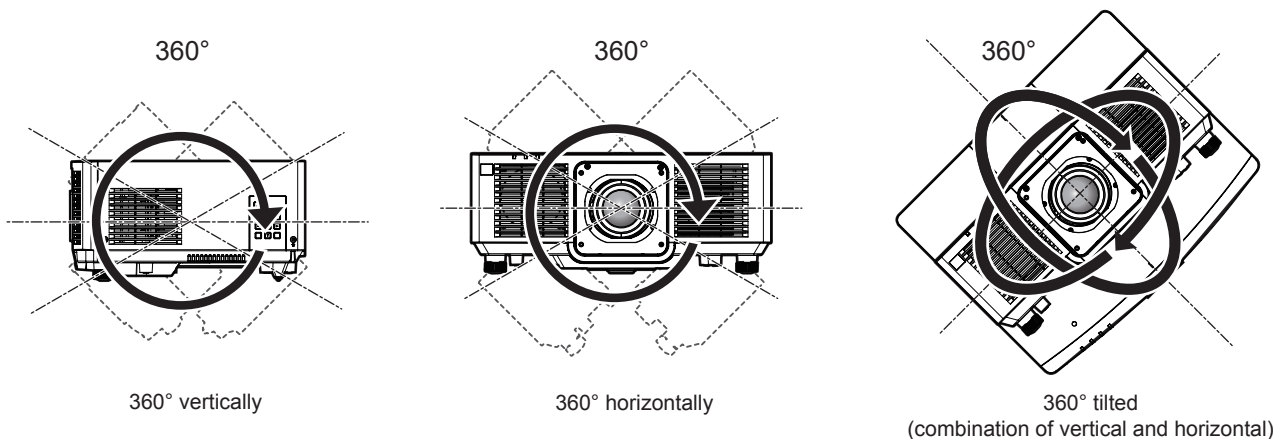

■ **Cautions when setting up the projector**

- Use the adjustable feet only for the floor standing installation and for adjusting the angle. Using them for other purposes may damage the projector.
- When installing the projector with a method other than the floor installation using the adjustable feet or the ceiling installation using the ceiling mount bracket, use the four screw holes for ceiling mount (as shown in the figure) to fix the projector.
In such case, make sure that there is no clearance between the screw holes for ceiling mount on the projector bottom and the setting surface by inserting spacers (metallic) between them.
- Use a torque screwdriver or Allen torque wrench to tighten the fixing screws to their specified tightening torques. Do not use electric screwdrivers or impact screwdrivers.
(Screw diameter: M6, tapping depth inside the projector: 12 mm (15/32"), screw tightening torque: 4 ± 0.5 N·m)

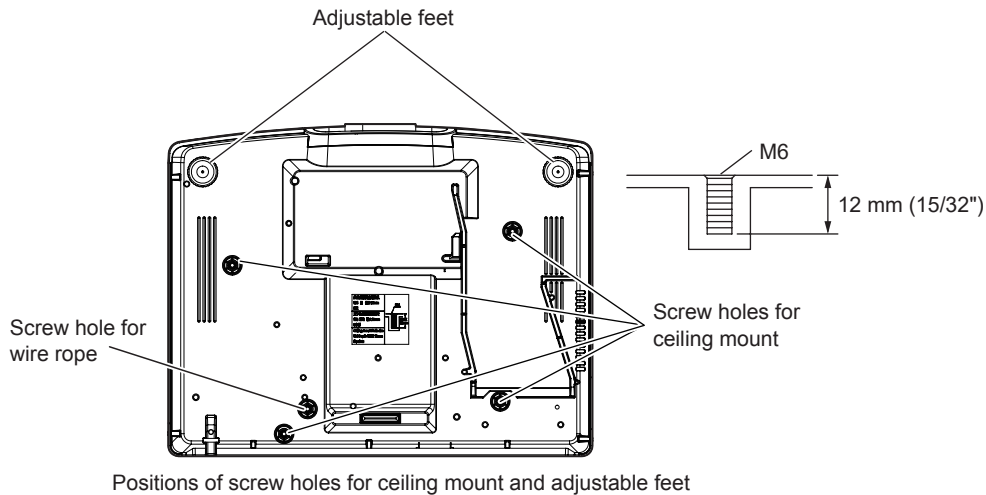

- Do not stack projectors on top of each other.
- Do not use the projector supporting it by the top.
- Do not block the intake and exhaust vents of the projector.
- Prevent hot and cool air from the air conditioning system to blow directly to the intake and exhaust vents of the projector.

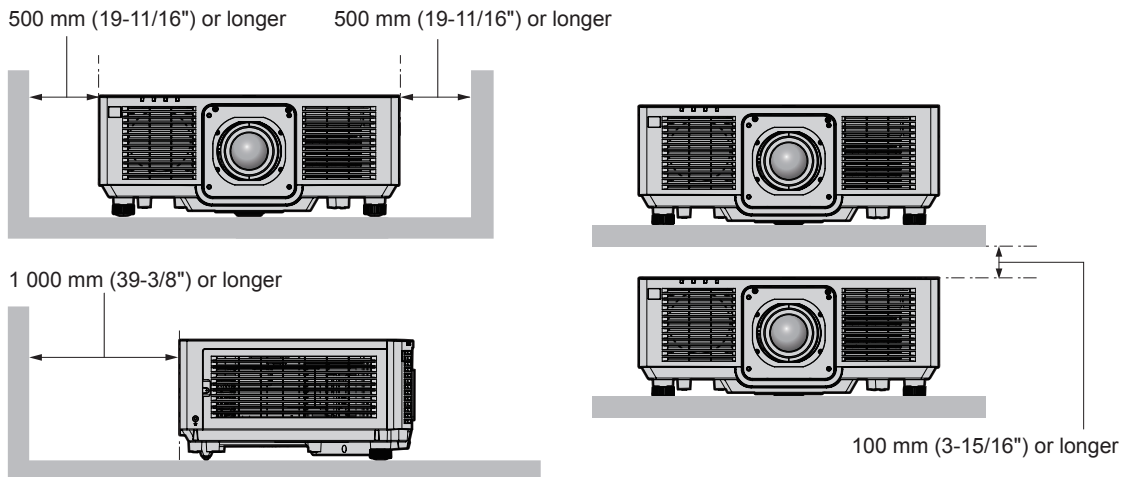
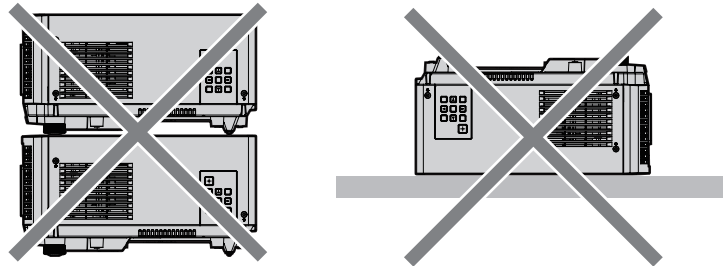

- Do not install the projector in a confined space.
When installing the projector in a confined space, provide air conditioning or ventilation separately. Exhaust heat may accumulate when the ventilation is not enough, triggering the protection circuit of the projector.
- Panasonic Connect Co., Ltd. takes no responsibility for any damage to the product caused by an inappropriate choice of location for installing the projector, even if the warranty period of the product has not expired.

Security

When using this product, take safety measures against the following incidents.

- Personal information being leaked via this product
- Unauthorized operation of this product by a malicious third party
- Interfering or stopping of this product by a malicious third party

Take sufficient security measures.

- Make your password difficult to guess as much as possible.
- Change your password periodically.
- Panasonic Connect Co., Ltd. or its affiliate companies will never ask for your password directly. Do not divulge your password in case you receive such inquiries.
- The connecting network must be secured by a firewall, etc.

DIGITAL LINK

“DIGITAL LINK” is a technology to transmit the video, audio, Ethernet, and serial control signals using a twisted pair cable by adding unique functions by Panasonic Connect Co., Ltd. to the HDBaseT™ communication standard formulated by HDBaseT Alliance.

This projector supports the optional DIGITAL LINK output supported device (Model No.: ET-YFB100G, ET-YFB200G) and peripheral devices by other manufacturers (twisted-pair-transmitters such as the “XTP transmitter” of Extron Electronics) based on the same HDBaseT™ standard. For the devices of other manufacturers that the operation has been verified with this projector, visit the website (<https://panasonic.net/cns/projector/>). Note that the verification for devices of other manufacturers has been made for the items set by Panasonic Connect Co., Ltd., and not all the operations have been verified. For operation or performance problems caused by the devices of other manufacturers, contact the respective manufacturers.

Art-Net

“Art-Net” is an Ethernet communication protocol based on the TCP/IP protocol.

By using the DMX controller and the application software, illumination and stage system can be controlled. Art-Net is made based on DMX512 communication protocol.

Application software supported by the projector

The projector supports following application software. For details or downloading application software other than the “Geometric & Setup Management Software”, visit the website (<https://panasonic.net/cns/projector/>).

- **Logo Transfer Software**

This application software transfers the original image, such as company logo, which is projected at the start, to the projector.

- **Smart Projector Control**

This application software sets and adjusts the projector connected via LAN using a smartphone or a tablet.

- **Multi Monitoring & Control Software**

This application software monitors and controls the multiple display devices (projector and flat panel display) connected to an intranet.

- **Early Warning Software**

This plug-in software monitors the status of the display devices and their peripherals within an intranet, and notifies of abnormality of such equipment and detects the signs of possible abnormality. “Early Warning Software” is preinstalled in the “Multi Monitoring & Control Software”. To use the early warning function of this plug-in software, install “Multi Monitoring & Control Software” in the PC to be used. By enabling the early warning function, it will notify of the approximate time to replace the consumables for the display devices, to clean each part of the display devices, and to replace the components of the display devices, allowing to execute maintenance in advance.

The early warning function can be used by registering maximum of 2048 display devices free of charge for 90 days after installing the “Multi Monitoring & Control Software” into a PC. To continuously use after the 90 days, it is necessary to purchase the license of “Early Warning Software” (ET-SWA100 Series) and perform the activation. Also, depending on the type of license, the number of display devices that can be registered for monitoring varies. For details, refer to the Operating Instructions of “Multi Monitoring & Control Software”.

- **Geometric & Setup Management Software (Geometry Manager Pro)**

This application software performs detailed corrections and adjustments such as the geometric adjustment which cannot be covered by the projector settings in real-time.

“Geometric & Setup Management Software” can be downloaded from the website (<https://panasonic.net/cns/projector/pass/>). It is necessary to register and login to PASS^{*1} to download.

^{*1} PASS: Panasonic Professional Display and Projector Technical Support Website
For details, visit the website (<https://panasonic.net/cns/projector/pass/>).

Storing

To store the projector, store in a dry room.

Disposal

To dispose of the product, ask your local authorities or dealer for correct methods of disposal. Also, dispose of the product without disassembling.

Cautions on use

■ To get a good picture quality

In order to view a beautiful image in higher contrast, prepare an appropriate environment. Draw curtains or blinds over windows and turn off any lights near the screen to prevent outside light or light from indoor lamps from shining onto the screen.

■ Do not touch the surface of the projection lens with your bare hands.

If the surface of the projection lens becomes dirty from fingerprints or anything else, this will be magnified and projected onto the screen.

Attach the lens cover supplied with the projector or with the optional projection lens to the projector when you do not use the projector.

■ LCD panel

The LCD panel is manufactured by a technology with extremely high precision, but there may be missing pixels or pixels that is constantly illuminated in a rare case. Note that these phenomenon are not malfunction.

Also, a residual image may remain in the image of the LCD panel when a still image is projected for long time, and in such case, project a full white image for 1 hour or longer. Note that the residual image may not be completely erased.

■ Do not move the projector or subject it to vibration or impact while it is operating.

Doing so may shorten the life of internal components or result in malfunctions.

■ Optical parts

The replacement cycle for the optical parts such as the LCD panel or polarization plate may become shorter even if it is used for less than one year when the ambient temperature is high or in an environment with large amount of dust or cigarette smoke. For details, consult your dealer.

■ Light source

The light source of the projector uses laser diode, and has the following characteristics.

- Depending on the operating environment temperature, the luminance of the light source will decrease.
The higher the temperature becomes, the more the luminance of the light source decreases.

- The luminance of the light source will decrease by duration of usage.

If brightness is noticeably reduced and the light source does not turn on, ask your dealer to clean inside the projector or replace the light source unit.

■ Computer and external device connections

When connecting a computer or an external device, read this manual carefully regarding the use of power cords and shielded cables as well.

Accessories

Make sure that the following accessories are provided with your projector. Numbers enclosed in < > show the number of accessories.

Wireless/wired remote control unit <1>
(N2QAYA000228)



For India
(K2CZ3YY00092)

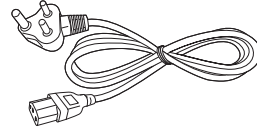

For Taiwan
(K2CG3YY00145)

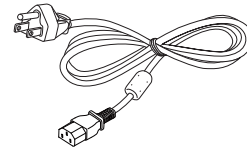

Power cord

(K2CM3YY00025)

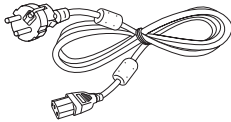

(K2CT3YY00049)

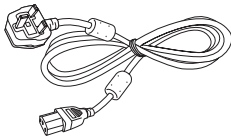

(K2CG3YY00106)

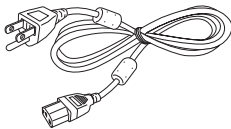

AAA/R03 or AAA/LR03 battery <2>

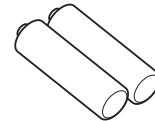

(For remote control unit)

Lens cover <1>
(6103626291)

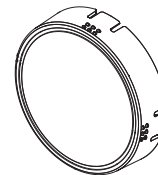

Attention

- After unpacking the projector, discard the power cord cap and packaging material properly.
- Do not use the supplied power cord for devices other than this projector.
- For missing accessories, consult your dealer.
- Store small parts in an appropriate manner, and keep them away from small children.

Note

- The type and number of the supplied power cords vary depending on the country or region where you purchased the product.
- The part numbers of accessories are subject to change without prior notice.

Optional accessories

Optional accessories (product name)		Model No.
Projection lens	Zoom Lens	ET-ELW20, ET-ELT22, ET-ELS20* ¹ , ET-ELT23, ET-ELW22
	Fixed-focus Lens	ET-ELW21
Ceiling Mount Bracket		ET-PKD120H (for High Ceilings) ET-PKD120S (for Low Ceilings) ET-PKE301B (Projector Mount Bracket)* ²
Early Warning Software (Basic license/3-year license)		ET-SWA100 Series* ³
Digital Interface Box		ET-YFB100G
DIGITAL LINK Switcher		ET-YFB200G
Replacement Filter Unit		ET-RFM100

*1 This product is equivalent to the standard zoom lens. The availability of this product varies depending on the country. For details, contact your dealer.

*2 When the projector is mounted to the existing Ceiling Mount Bracket (in combination with the Model No.: ET-PKD120H (for High Ceilings) or ET-PKD120S (for Low Ceilings), and the Model No.: ET-PKE300B (Projector Mount Bracket)), it is necessary to replace the drop-prevention wire rope with the one corresponding to this projector. Consult your dealer.

Drop-prevention set (service model no.: DPPW1004ZA/X1)

*3 The suffix of the Model No. differs according to the license type.

Note

- The model numbers of optional accessories are subject to change without prior notice.
- The optional accessories compatible with the projector may be added or changed without prior notice. The optional accessories described in this document are as of May 2021.
For the latest information, visit the website (<https://panasonic.net/cns/projector/>).

About your projector

Remote control

■ Front

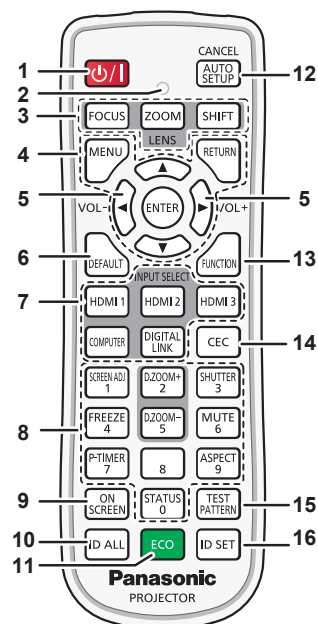

■ Top

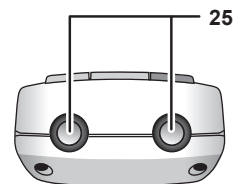

■ Bottom

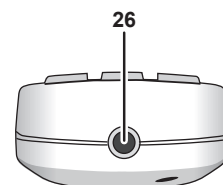
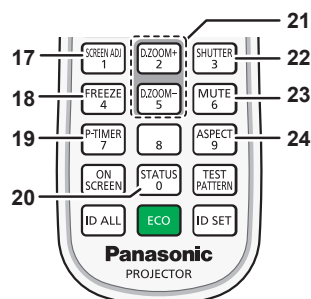

1 Power <⏻/⏻> button

(⏻: Standby, |: Power on)

Sets the projector to the state where the projector is turned off (standby mode) when the <MAIN POWER> switch on the projector is set to <ON> and in projection mode.

Sets the projector to projection mode when the power is switched off (standby mode).

2 Remote control indicator

Blinks if any button in the remote control is pressed.

3 Lens buttons (<FOCUS>, <ZOOM>, <SHIFT>)

Adjusts the focus, zoom, and lens shift of the lens. (➔ page 63)

4 <MENU> button/<RETURN> button/<ENTER> button/▲▼◀▶ buttons

Used to navigate through the menu screen. (➔ page 74)

▲▼◀▶ buttons are also used to enter the password in [SECURITY] or enter characters.

5 <VOL-> button/<VOL+> button

Adjusts the volume of the audio output. (➔ page 67)

6 <DEFAULT> button

Resets the content of the displayed sub-menu to the factory default. (➔ page 75)

7 Input selection buttons (<HDMI 1>, <HDMI 2>, <HDMI 3>, <COMPUTER>, <DIGITAL LINK>)

Switches the input signal to project. (➔ page 62)

8 Number (<0> - <9>) buttons

Used for entering an ID number in a multiple projector environment or a password.

9 <ON SCREEN> button

Switches the on-screen display function on (display) or off (hide). (➔ page 67)

10 <ID ALL> button

Used to simultaneously control all the projectors with a single remote control in a multiple projector environment. (➔ page 34)

11 <ECO> button

Displays the setting screen relating to ECO management. (➔ pages 71, 111)

12 <AUTO SETUP/CANCEL> button

Automatically adjusts the image display position while projecting the image.

[PROGRESS] is displayed while in automatic adjustment.

(➔ page 68)

Also used to cancel operation during digital zoom.

13 <FUNCTION> button

Assigns a frequently used operation as a shortcut button. (➔ page 70)

14 <CEC> button

Displays the HDMI-CEC operation screen. (➔ page 126)

15 <TEST PATTERN> button

Displays the test pattern. (➔ page 70)

16 <ID SET> button

Sets the ID number of the remote control in a multiple projector environment. (➔ page 34)

17 <SCREEN ADJ> button

Used to correct the distortion of the projected image. (➔ pages 68, 88)

18 <FREEZE> button

Used when pausing the image and turning off the audio. (➔ page 67)

19 <P-TIMER> button

Operates the presentation timer function. (➔ page 70)

20 <STATUS> button

Displays the projector information.

21 <D.ZOOM+> button/<D.ZOOM-> button

Enlarges or reduces the image. (➔ page 69)

22 <SHUTTER> button

Used when temporarily turning off the image and audio. (➔ page 66)

23 <MUTE> button

Used when temporarily turning off the audio. (➔ page 66)

24 <ASPECT> button

Switches the aspect ratio of the image. (➔ page 70)

25 Remote control signal transmitter

26 Remote control wired terminal

This is a terminal used to connect to the projector via a cable when the remote control is used as a wired remote control. (➔ page 34)

Attention

- Do not drop the remote control.
 - Avoid contact with liquids or moisture.
 - Do not attempt to modify or disassemble the remote control.
 - Observe the following instructions that are indicated on the caution label at the back of the remote control:
 - Do not use old battery with new one.
 - Do not use batteries other than the type specified.
 - Be sure the batteries are inserted properly.
- For other instructions, read the instructions related to batteries that are described in "Read this first!".



Caution label at the back of the remote control

Note

- When operating the remote control by directly pointing at the remote control signal receiver of the projector, operate the remote control within a distance approximately 30 m (98'5") from the remote control signal receiver. The remote control can control at angles of up to $\pm 30^\circ$ vertically and horizontally, but the effective control range may be reduced.
- If there are any obstacles between the remote control and the remote control signal receiver, the remote control may not operate properly.
- The signal will be reflected off the screen. However, the operating range may be limited from light reflection loss due to the screen material.
- If the remote control signal receiver directly receives strong light, such as fluorescent light, the remote control may not operate properly. Use it in a place distant from the light source.
- The power indicator <ON (G)/STANDBY (R)> will blink if the projector receives a remote control signal.

Projector body

■ Front

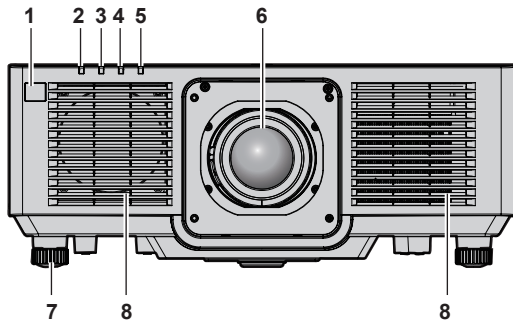

■ Side

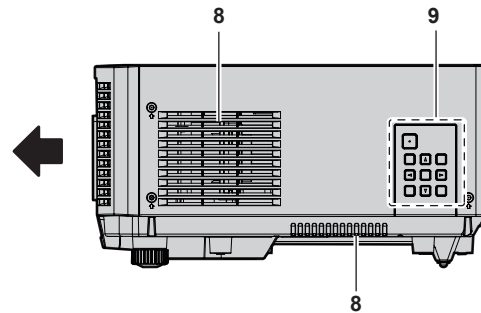

■ Rear

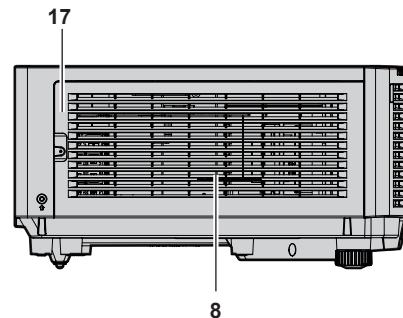
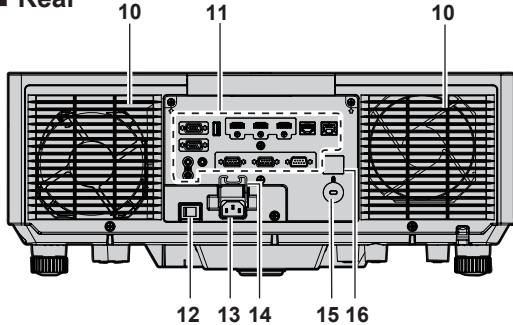

■ Top

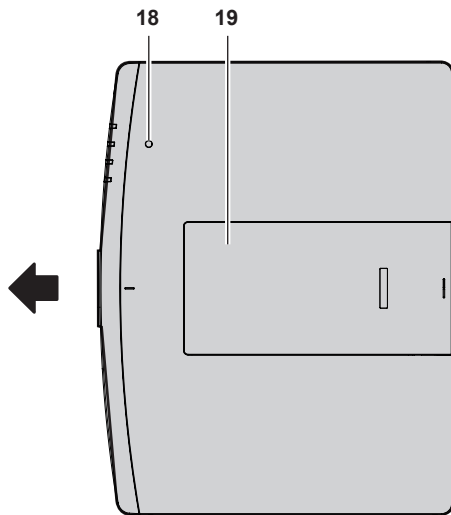

■ Bottom

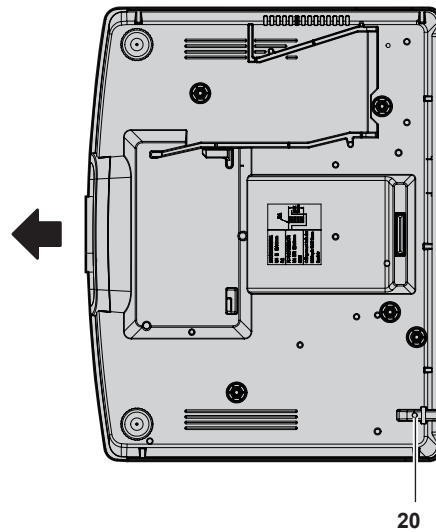

← : Projection direction

- | | |
|---|---|
| <ul style="list-style-type: none"> 1 Remote control signal receiver (front) 2 Power indicator <ON (G)/STANDBY (R)>
Indicates the status of the power. 3 Light source indicator <LIGHT>
Indicates the status of the light source. 4 Temperature indicator <TEMP>
Indicates the internal temperature status. 5 Filter indicator <FILTER>
Indicates the status of the air filter unit. 6 Projection lens 7 Adjustable feet
Adjusts the projection angle. 8 Intake vent 9 Control panel (⇒ page 32) 10 Exhaust vent 11 Connecting terminals (⇒ page 33) | <ul style="list-style-type: none"> 12 <MAIN POWER> switch
Turns on/off the main power. 13 <AC IN> terminal
Connect the supplied power cord. 14 Power cord holder 15 Security slot
This security slot is compatible with the Kensington security cables. 16 Remote control signal receiver (rear) 17 Air filter cover
There is the air filter unit inside. 18 Luminance sensor (⇒ page 82) 19 Top slide cover
There is the lens lock lever for mounting the projection lens inside. (⇒ page 44) 20 Burglar hook port
Attaches a burglar prevention cable, etc. |
|---|---|

Attention

- Do not block the intake and exhaust vents of the projector.
The components may deteriorate faster if cooling inside the projector is inhibited.

■ Control panel

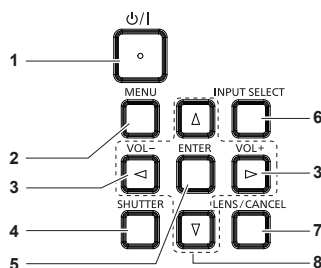

- | | |
|--|---|
| <ul style="list-style-type: none"> 1 Power <⏻/⏻> button
(⏻: Standby, : Power on)
Sets the projector to the state where the projector is turned off (standby mode) when the <MAIN POWER> switch on the projector is set to <ON> and in projection mode.
Sets the projector to projection mode when the power is switched off (standby mode). | <ul style="list-style-type: none"> 2 <MENU> button
Displays or hides the main menu. (⇒ page 74)
Returns to the previous menu when a sub-menu is displayed. 3 <VOL-> button/<VOL+> button
Adjusts the volume of the audio output. (⇒ page 67) 4 <SHUTTER> button
Used to turn off the image and audio temporarily. (⇒ page 66) |
|--|---|

5 <ENTER> button

Determines and executes an item in the menu screen.

6 <INPUT SELECT> button

Switches the input signal to project. (➔ page 62)

7 <LENS/CANCEL> button

Adjusts the focus, zoom, and lens shift of the lens. (➔ page 63)
Also used to cancel operation during digital zoom.

8 ▲▼◀▶ buttons

Selects an item in the menu screen, changes the setting, and adjusts the level.
Also used to enter a password in the [SECURITY] menu or enter characters.

■ **Connecting terminals**

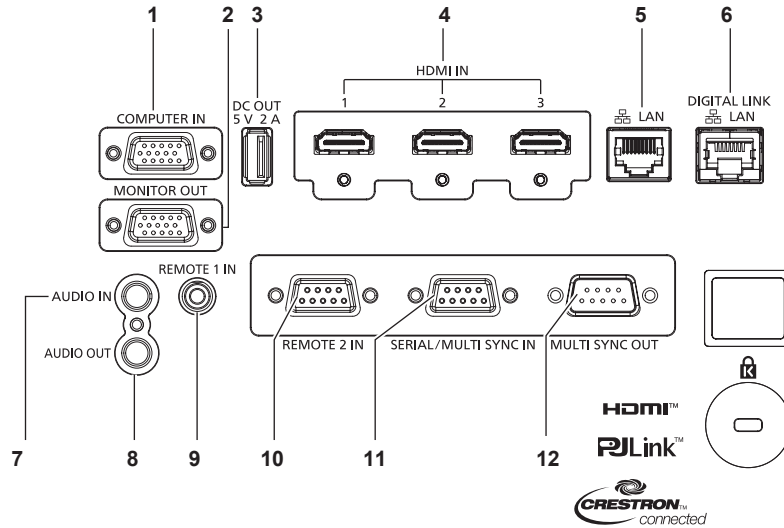

1 <COMPUTER IN> terminal

This is a terminal to input the RGB signal or YC_BCR/YP_BPR signal.

2 <MONITOR OUT> terminal

This is a terminal to output the RGB signal or the YC_BCR/YP_BPR signal input in the <COMPUTER IN> terminal.

3 <DC OUT> terminal

This is the USB terminal only used for power supply. (DC 5 V, maximum 2 A)
This can be used when power is to be supplied to a wireless display adapter, etc.

4 <HDMI IN 1> terminal/<HDMI IN 2> terminal/<HDMI IN 3> terminal

This is a terminal to input the HDMI signal.

5 <LAN> terminal

This is the LAN terminal to connect to the network.

6 <DIGITAL LINK/LAN> terminal

This is a terminal to connect a device that transmits video signal or audio signal via the LAN terminal. Also, this is the LAN terminal to connect to the network.

7 <AUDIO IN> terminal

This is a terminal to input audio.

8 <AUDIO OUT> terminal

This is a terminal to output the audio signal input to the projector.

9 <REMOTE 1 IN> terminal

This is a terminal to connect the remote control with a cable when controlling the projector with a wired remote control.

10 <REMOTE 2 IN> terminal

This is a terminal to remotely control the projector using the external control circuit.

11 <SERIAL/MULTI SYNC IN> terminal

This is the RS-232C compatible terminal to externally control the projector by connecting a computer.
This terminal is also used to connect multiple projectors when balancing the contrast as a combined screen or synchronizing the effects using the shutter function including the fade in/fade out with a system using multiple projectors.

12 <MULTI SYNC OUT> terminal

This terminal is used to connect multiple projectors when balancing the contrast as a combined screen or synchronizing the effects using the shutter function including the fade in/fade out with a system using multiple projectors.

Attention

- When a LAN cable is directly connected to the projector, the network connection must be made indoors.
The signal may deteriorate due to the effect of noise or cable length.
- To transmit the Ethernet and serial control signals using the <DIGITAL LINK/LAN> terminal, set the [NETWORK] menu → [ETHERNET TYPE] to [DIGITAL LINK] or [LAN & DIGITAL LINK].
- To transmit the Ethernet signal using the <LAN> terminal, set the [NETWORK] menu → [ETHERNET TYPE] to [LAN] or [LAN & DIGITAL LINK].
- The <DIGITAL LINK/LAN> terminal and the <LAN> terminal are connected inside of the projector when the [NETWORK] menu → [ETHERNET TYPE] is set to [LAN & DIGITAL LINK]. Do not directly connect the <DIGITAL LINK/LAN> terminal and the <LAN> terminal using a LAN cable. Construct the system so that it is not connected to the same network via the peripherals such as the switching hub or the twisted-pair-cable transmitter.

Preparing the remote control

Inserting and removing the batteries

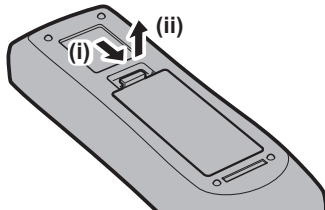

Fig. 1

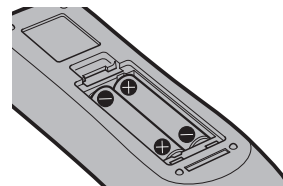



Fig. 2

- 1) Open the cover. (Fig. 1)
- 2) Insert the batteries and close the cover (insert the  side first). (Fig. 2)
 - When removing the batteries, perform the steps in reverse order.

When using the multiple projectors

When you use the multiple projectors together, you can operate all the projectors simultaneously or each projector individually using single remote control, if a unique ID number is assigned to each projector.

When using the projectors by setting the ID numbers, set the ID number of the projector body after initial settings have been completed. Then, set the ID number of the remote control. For initial settings, refer to “When the initial setting screen is displayed” (➔ page 55).

The factory default ID number of the projector (projector body and remote control) is set to [ALL], so you can use it as it is. Set the ID numbers of the projector body and remote control as necessary.

For details on setting the ID number of the remote control, refer to “Setting ID number of the remote control” (➔ page 72).

Note

- Set the ID number of the projector body from the [PROJECTOR SETUP] menu → [PROJECTOR ID].

Connecting the remote control to the projector with a cable

To control the projector with a wired remote control, connect the remote control wired terminal of the remote control with the <REMOTE 1 IN> terminal of the projector with commercially available M3 stereo mini jack cable. This is effective when using the projector in location where there is an obstacle between the projector and the remote control or location that is affected by the outside light.

- The wireless remote control cannot be used when a cable is connected to the <REMOTE 1 IN> terminal of the projector.

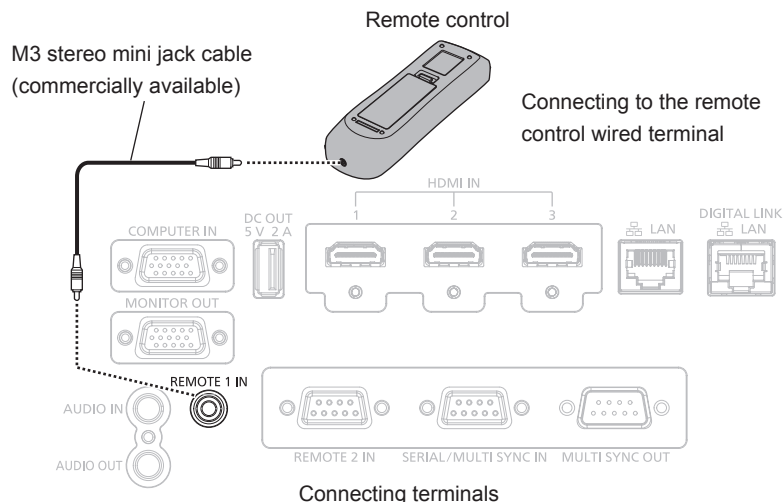

Attention

- Use a cable that is 15 m (49'3") or shorter, with 2 core shielded. The remote control may not operate when the length of the cable exceeds 15 m (49'3") or when the shielding of the cable is inadequate.

Chapter 2 **Getting Started**

This chapter describes things you need to do before using the projector such as the setup and connections.

Setting up

Installation mode

The installation modes of the projector are as follows. Set [FRONT/REAR]/[FLOOR/CEILING] in the [PROJECTOR SETUP] menu → [PROJECTION METHOD] (➔ page 110) depending on the installation mode.

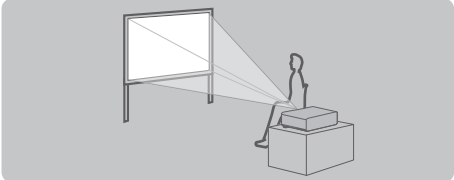
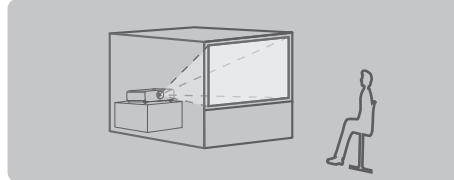
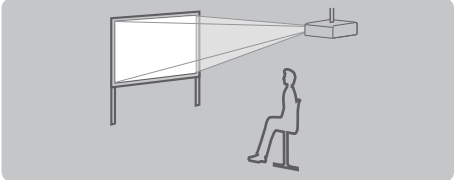
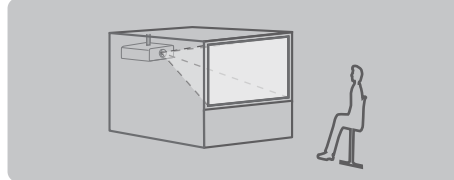
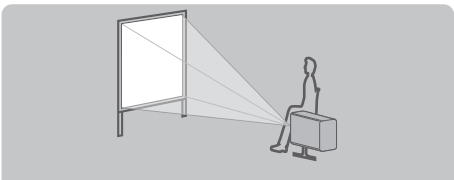
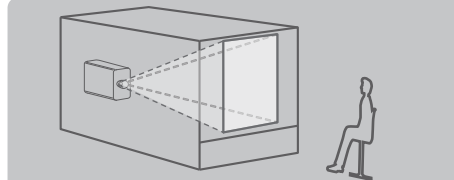
Setting on a desk/floor and projecting forward 		Setting on a desk/floor and projecting from rear (Using the translucent screen) 	
Menu item	Setting value	Menu item	Setting value
[FRONT/REAR]	[FRONT]	[FRONT/REAR]	[REAR]
[FLOOR/CEILING]	[AUTO] or [FLOOR]	[FLOOR/CEILING]	[AUTO] or [FLOOR]
Mounting on the ceiling and projecting forward 		Mounting on the ceiling and projecting from rear (Using the translucent screen) 	
Menu item	Setting value	Menu item	Setting value
[FRONT/REAR]	[FRONT]	[FRONT/REAR]	[REAR]
[FLOOR/CEILING]	[AUTO] or [CEILING]	[FLOOR/CEILING]	[AUTO] or [CEILING]
Portrait setting and projecting forward 		Portrait setting and projecting from rear (Using the translucent screen) 	
Menu item	Setting value	Menu item	Setting value
[FRONT/REAR]	[FRONT]	[FRONT/REAR]	[REAR]
[FLOOR/CEILING]	Set in accordance with the image to project.	[FLOOR/CEILING]	Set in accordance with the image to project.

Note

- In the portrait setting, the on-screen menu is displayed sideways. To display the on-screen menu vertically, go to the [DISPLAY OPTION] menu → [ON-SCREEN DISPLAY] (➔ page 102) and change the [OSD ROTATION] setting.
- The projector has a built-in angle sensor. The attitude of the projector is automatically detected by setting [FLOOR/CEILING] to [AUTO] in the [PROJECTOR SETUP] menu → [PROJECTION METHOD].

■ Angle sensor

The range of the installation attitude that is detected by the angle sensor built-in the projector is as follows.

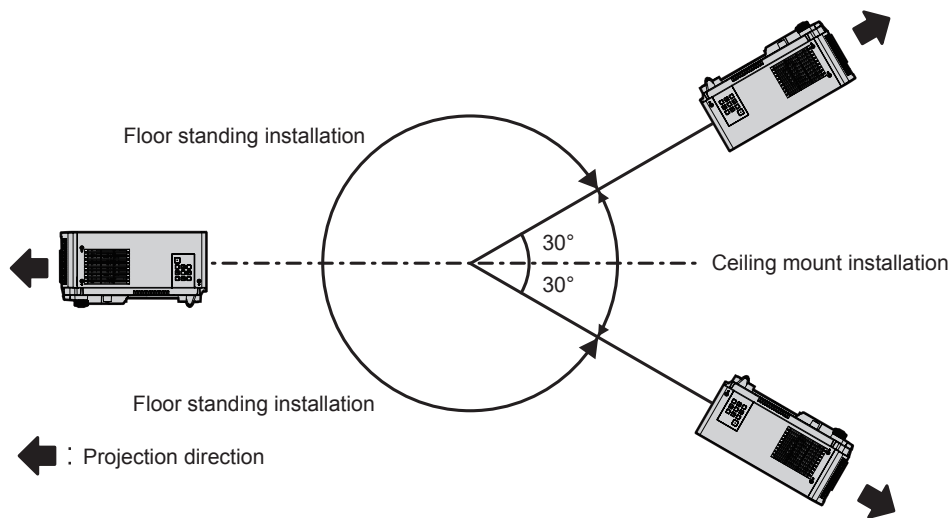

Parts for installation (optional)

The optional Ceiling Mount Bracket is required. The Ceiling Mount Bracket (Model No.: ET-PKD120H (for High Ceilings) or ET-PKD120S (for Low Ceilings)) is used together with the Ceiling Mount Bracket (Model No.: ET-PKE301B (Projector Mount Bracket)).

Model No.: ET-PKD120H (for High Ceilings), ET-PKD120S (for Low Ceilings), ET-PKE301B (Projector Mount Bracket)

When the projector is mounted to the existing Ceiling Mount Bracket (in combination with the Model No.: ET-PKD120H (for High Ceilings) or ET-PKD120S (for Low Ceilings), and the Model No.: ET-PKE300B (Projector Mount Bracket)), it is necessary to replace the drop-prevention wire rope with the one corresponding to this projector. Consult your dealer.

Drop-prevention set (service model no.: DPPW1004ZA/X1)

- Be sure to use the Ceiling Mount Bracket specified for this projector.
- Refer to the Installation Instructions of the Ceiling Mount Bracket when installing and setting up the projector.

Attention

- To ensure projector performance and security, installation of the Ceiling Mount Bracket must be carried out by your dealer or a qualified technician.

Projected image and throw distance

Install the projector referring to the projected image size and projection distance. Image size and image position can be adjusted in accordance with the screen size and screen position.

- Following illustration is prepared on the assumption that the projected image size and position have been aligned to fit full in the screen.

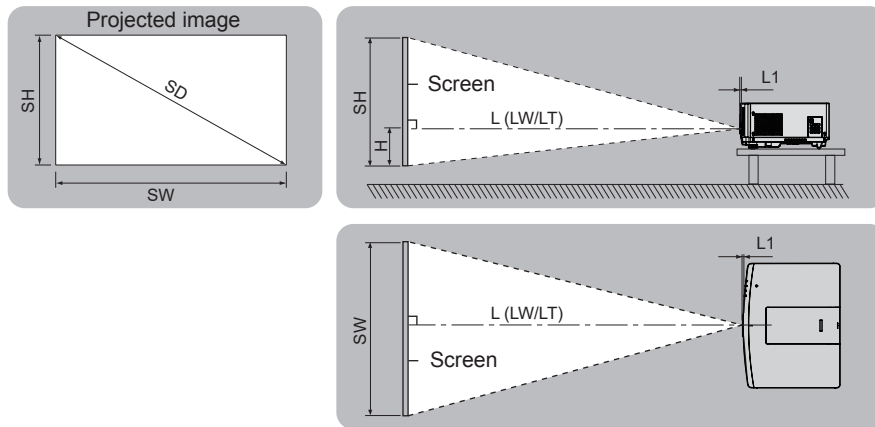

$L (LW/LT)^{*1}$	Projection distance
L1	Lens protrusion dimension
SH	Projected image height
SW	Projected image width
H	Distance from the lens center to the bottom edge of the projected image
SD	Projected image size

*1 LW: Minimum projection distance when the Zoom Lens is used
 LT: Maximum projection distance when the Zoom Lens is used

(Unit: m)

Projection lens Model No.	Dimension for L1 (approximate value)
Standard zoom lens / ET-ELS20	0.002
ET-ELW21	-0.008
ET-ELW22	0.037
ET-ELW20	0.022
ET-ELT22	0.023
ET-ELT23	0.019

Attention

- Before setting up, read "Precautions for use" (➔ page 23).

[SCREEN ADJUSTMENT] projection range

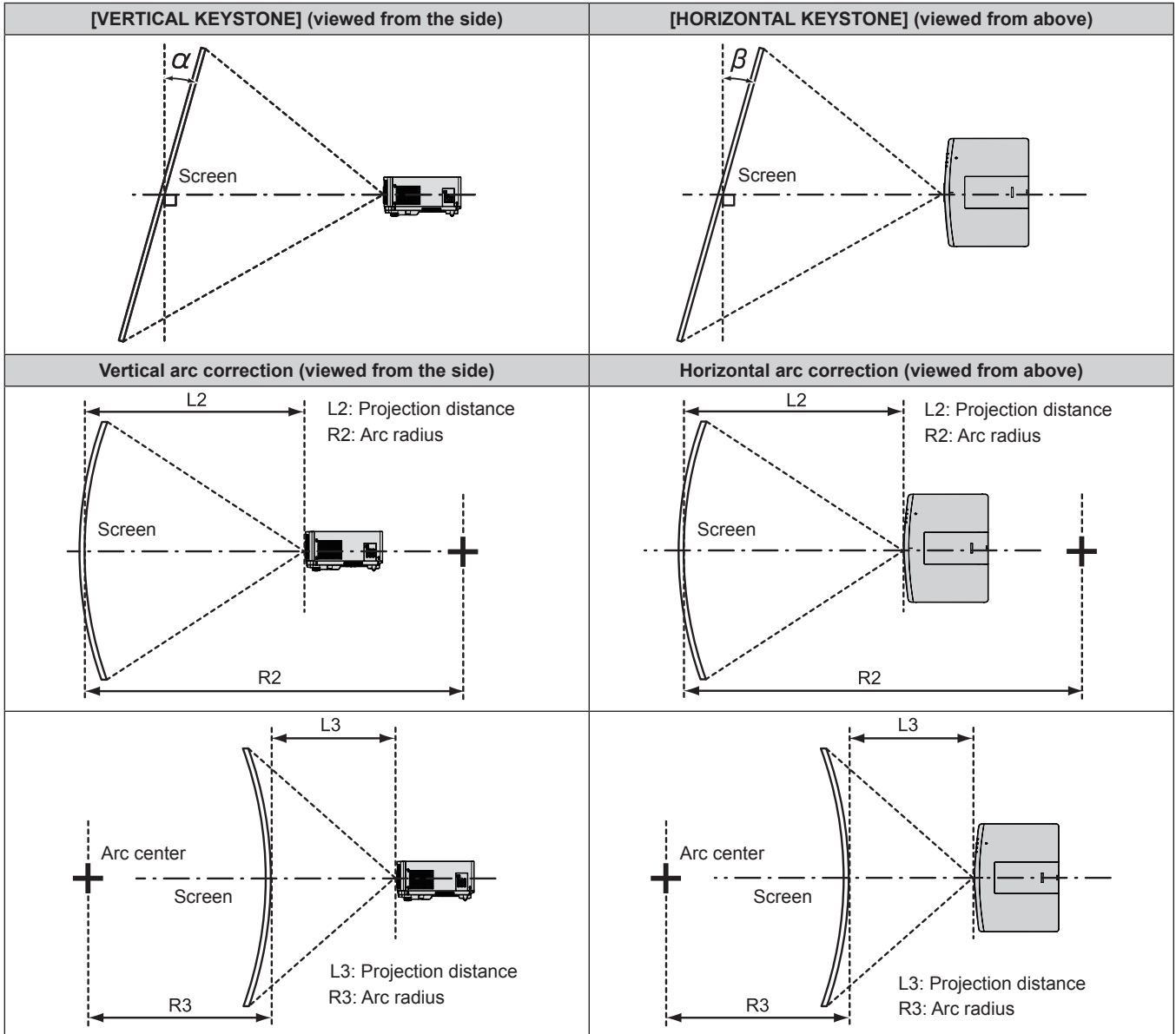

Projection lens Model No.	Only [KEYSTONE] used*1		[KEYSTONE] and [CURVED CORRECTION] used together				Only [CURVED CORRECTION] used	
	Vertical keystone correction angle α (°)	Horizontal keystone correction angle β (°)	Vertical keystone correction angle α (°)	Horizontal keystone correction angle β (°)	Min. value of R2/L2	Min. value of R3/L3	Min. value of R2/L2	Min. value of R3/L3
Standard zoom lens/ET-ELS20	±25	±30	±20	±15	0.9	1.8	0.5	1.0
ET-ELW21	±22	±15	±8	±8	1.7	4.3	1.0	2.6
ET-ELW22	±22	±15	±8	±8	1.7	4.3	1.0	2.6
ET-ELW20	±25	±30	±20	±15	1.2	3.1	0.7	1.8
ET-ELT22	±25	±30	±20	±15	0.6	1.1	0.3	0.6
ET-ELT23	±25	±30	±20	±15	0.4	0.7	0.2	0.4

*1 When [VERTICAL KEYSTONE] and [HORIZONTAL KEYSTONE] are used simultaneously, correction cannot be made exceeding total of 55°.

Note

- When [SCREEN ADJUSTMENT] is used, the focus of the entire screen may be lost as correction increases.
- Make the curved screen a circular arc shape with one part of a perfect circle removed.

Projection distance of each projection lens

A ±5 % error in listed projection distances may occur.

When [SCREEN ADJUSTMENT] is used, distance is corrected to become smaller than the specified image size.

■ **When the screen aspect ratio is 16:10**

(Unit: m)

Lens type			Zoom Lens										Fixed-focus Lens
Projection lens Model No.			Standard zoom lens/ET-ELS20		ET-ELW22		ET-ELW20		ET-ELT22		ET-ELT23		ET-ELW21
Throw ratio*1			1.61-2.76:1		0.786-0.983:1		1.21-1.66:1		2.72-4.48:1		4.44-7.12:1		0.764:1
Projected image size			Projection distance (L)										
Diagonal (SD)	Height (SH)	Width (SW)	Min. (LW)	Max. (LT)	Min. (LW)	Max. (LT)	Min. (LW)	Max. (LT)	Min. (LW)	Max. (LT)	Min. (LW)	Max. (LT)	Fixed
1.016 (40")	0.538	0.862	1.36	2.35	—	—	1.02	1.41	2.29	3.81	3.72	6.03	0.63
1.270 (50")	0.673	1.077	1.71	2.95	—	—	1.29	1.77	2.89	4.79	4.70	7.59	0.80
1.524 (60")	0.808	1.292	2.06	3.55	1.00	1.26	1.55	2.14	3.49	5.77	5.68	9.15	0.97
1.778 (70")	0.942	1.508	2.42	4.15	1.18	1.48	1.82	2.50	4.09	6.75	6.66	10.71	1.14
2.032 (80")	1.077	1.723	2.77	4.76	1.35	1.69	2.09	2.87	4.69	7.73	7.64	12.27	1.32
2.286 (90")	1.212	1.939	3.12	5.36	1.53	1.91	2.36	3.23	5.30	8.71	8.63	13.83	1.49
2.540 (100")	1.346	2.154	3.48	5.96	1.71	2.13	2.63	3.60	5.90	9.69	9.61	15.39	1.66
3.048 (120")	1.615	2.585	4.18	7.16	2.06	2.56	3.16	4.33	7.10	11.65	11.57	18.51	2.00
3.810 (150")	2.019	3.231	5.24	8.96	2.58	3.22	3.97	5.42	8.90	14.59	14.52	23.19	2.52
5.080 (200")	2.692	4.308	7.01	11.96	3.46	4.30	5.31	7.25	11.91	19.49	19.43	30.99	3.38
6.350 (250")	3.365	5.385	8.77	14.96	4.34	5.39	6.65	9.07	14.91	24.39	24.34	38.79	4.24
7.620 (300")	4.039	6.462	10.54	17.97	5.21	6.48	7.99	10.90	17.92	29.29	29.25	46.59	5.10
8.890 (350")	4.712	7.539	12.30	20.97	6.09	7.56	9.33	12.73	20.92	34.19	34.16	54.39	5.95
10.160 (400")	5.385	8.616	14.07	23.97	6.97	8.65	10.67	14.55	23.93	39.09	39.07	62.19	6.81

Projection lens Model No.			Standard zoom lens/ ET-ELS20/ET-ELW20/ ET-ELT22/ET-ELT23		ET-ELW22	ET-ELW21 (Fixed)
Projected image size			Height position (H) ²			
Diagonal (SD)	Height (SH)	Width (SW)				
1.016 (40")	0.538	0.862	-0.09 - 0.63			
1.270 (50")	0.673	1.077	-0.11 - 0.79			
1.524 (60")	0.808	1.292	-0.14 - 0.95		-0.08 - 0.89	
1.778 (70")	0.942	1.508	-0.16 - 1.10		-0.09 - 1.04	
2.032 (80")	1.077	1.723	-0.18 - 1.26		-0.11 - 1.18	
2.286 (90")	1.212	1.939	-0.21 - 1.42		-0.12 - 1.33	
2.540 (100")	1.346	2.154	-0.23 - 1.58		-0.13 - 1.48	
3.048 (120")	1.615	2.585	-0.27 - 1.89		-0.16 - 1.78	
3.810 (150")	2.019	3.231	-0.34 - 2.36		-0.20 - 2.22	
5.080 (200")	2.692	4.308	-0.46 - 3.15		-0.27 - 2.96	
6.350 (250")	3.365	5.385	-0.57 - 3.94		-0.34 - 3.70	
7.620 (300")	4.039	6.462	-0.69 - 4.73		-0.40 - 4.44	
8.890 (350")	4.712	7.539	-0.80 - 5.51		-0.47 - 5.18	
10.160 (400")	5.385	8.616	-0.92 - 6.30		-0.54 - 5.92	

*1 The throw ratio is based on the value during projection of 2.03 m (80") projected image size.

*2 When the Fixed-focus Lens (Model No.: ET-ELW21) is attached, the lens shift is not possible, therefore the height position (H) becomes SH/2.

■ When the screen aspect ratio is 16:9

(Unit: m)

Lens type			Zoom Lens										Fixed-focus Lens
Projection lens Model No.			Standard zoom lens/ET-ELS20		ET-ELW22		ET-ELW20		ET-ELT22		ET-ELT23		ET-ELW21
Throw ratio*1			1.61-2.76:1		0.787-0.984:1		1.21-1.66:1		2.73-4.49:1		4.44-7.12:1		0.765:1
Projected image size			Projection distance (L)										
Diagonal (SD)	Height (SH)	Width (SW)	Min. (LW)	Max. (LT)	Min. (LW)	Max. (LT)	Min. (LW)	Max. (LT)	Min. (LW)	Max. (LT)	Min. (LW)	Max. (LT)	Fixed
1.016 (40")	0.498	0.886	1.40	2.42	—	—	1.05	1.45	2.36	3.92	3.83	6.20	0.65
1.270 (50")	0.623	1.107	1.76	3.04	—	—	1.32	1.82	2.97	4.92	4.83	7.81	0.83
1.524 (60")	0.747	1.328	2.12	3.65	1.03	1.30	1.60	2.20	3.59	5.93	5.84	9.41	1.00
1.778 (70")	0.872	1.550	2.49	4.27	1.21	1.52	1.87	2.57	4.21	6.94	6.85	11.01	1.18
2.032 (80")	0.996	1.771	2.85	4.89	1.39	1.74	2.15	2.95	4.83	7.95	7.86	12.62	1.35
2.286 (90")	1.121	1.992	3.21	5.51	1.57	1.97	2.43	3.32	5.45	8.95	8.87	14.22	1.53
2.540 (100")	1.245	2.214	3.57	6.12	1.75	2.19	2.70	3.70	6.06	9.96	9.88	15.82	1.71
3.048 (120")	1.494	2.657	4.30	7.36	2.11	2.64	3.25	4.45	7.30	11.97	11.90	19.03	2.06
3.810 (150")	1.868	3.321	5.39	9.21	2.66	3.31	4.08	5.58	9.15	15.00	14.93	23.84	2.59
5.080 (200")	2.491	4.428	7.20	12.29	3.56	4.42	5.46	7.45	12.24	20.03	19.98	31.86	3.47
6.350 (250")	3.113	5.535	9.02	15.38	4.46	5.54	6.83	9.33	15.33	25.07	25.02	39.87	4.36
7.620 (300")	3.736	6.641	10.83	18.47	5.36	6.66	8.21	11.20	18.42	30.10	30.07	47.89	5.24
8.890 (350")	4.358	7.748	12.65	21.55	6.26	7.77	9.59	13.08	21.51	35.14	35.12	55.91	6.12
10.160 (400")	4.981	8.855	14.46	24.64	7.16	8.89	10.97	14.96	24.60	40.18	40.17	63.92	7.00

Projection lens Model No.			Standard zoom lens/ ET-ELS20/ET-ELW20/ ET-ELT22/ET-ELT23		ET-ELW22	ET-ELW21 (Fixed)
Projected image size			Height position (H) ²			
Diagonal (SD)	Height (SH)	Width (SW)				
1.016 (40")	0.498	0.886	-0.12 - 0.62		—	0.25
1.270 (50")	0.623	1.107	-0.15 - 0.77		—	0.31
1.524 (60")	0.747	1.328	-0.18 - 0.93		-0.12 - 0.87	0.37
1.778 (70")	0.872	1.550	-0.21 - 1.08		-0.15 - 1.02	0.44
2.032 (80")	0.996	1.771	-0.24 - 1.24		-0.17 - 1.16	0.50
2.286 (90")	1.121	1.992	-0.27 - 1.39		-0.19 - 1.31	0.56
2.540 (100")	1.245	2.214	-0.30 - 1.55		-0.21 - 1.45	0.62
3.048 (120")	1.494	2.657	-0.37 - 1.86		-0.25 - 1.74	0.75
3.810 (150")	1.868	3.321	-0.46 - 2.32		-0.31 - 2.18	0.93
5.080 (200")	2.491	4.428	-0.61 - 3.10		-0.42 - 2.91	1.25
6.350 (250")	3.113	5.535	-0.76 - 3.87		-0.52 - 3.63	1.56
7.620 (300")	3.736	6.641	-0.91 - 4.65		-0.62 - 4.36	1.87
8.890 (350")	4.358	7.748	-1.07 - 5.42		-0.73 - 5.08	2.18
10.160 (400")	4.981	8.855	-1.22 - 6.20		-0.83 - 5.81	2.49

*1 The throw ratio is based on the value during projection of 2.03 m (80") projected image size.

*2 When the Fixed-focus Lens (Model No.: ET-ELW21) is attached, the lens shift is not possible, therefore the height position (H) becomes SH/2.

■ When the screen aspect ratio is 4:3

(Unit: m)

Lens type			Zoom Lens										Fixed-focus Lens
Projection lens Model No.			Standard zoom lens/ET-ELS20		ET-ELW22		ET-ELW20		ET-ELT22		ET-ELT23		ET-ELW21
Throw ratio*1			1.93-3.32:1		0.947-1.18:1		1.46-2.00:1		3.28-5.39:1		5.34-8.56:1		0.922:1
Projected image size			Projection distance (L)										
Diagonal (SD)	Height (SH)	Width (SW)	Min. (LW)	Max. (LT)	Min. (LW)	Max. (LT)	Min. (LW)	Max. (LT)	Min. (LW)	Max. (LT)	Min. (LW)	Max. (LT)	Fixed
1.016 (40")	0.610	0.813	1.54	2.67	—	—	1.16	1.60	2.61	4.33	4.24	6.85	0.72
1.270 (50")	0.762	1.016	1.94	3.35	—	—	1.46	2.01	3.29	5.43	5.35	8.62	0.91
1.524 (60")	0.914	1.219	2.34	4.03	1.14	1.43	1.77	2.43	3.97	6.54	6.46	10.39	1.11
1.778 (70")	1.067	1.422	2.74	4.71	1.34	1.68	2.07	2.84	4.65	7.65	7.57	12.15	1.30
2.032 (80")	1.219	1.626	3.14	5.39	1.54	1.92	2.37	3.25	5.33	8.76	8.68	13.92	1.50
2.286 (90")	1.372	1.829	3.54	6.07	1.74	2.17	2.68	3.67	6.01	9.87	9.79	15.68	1.69
2.540 (100")	1.524	2.032	3.94	6.75	1.94	2.42	2.98	4.08	6.69	10.98	10.91	17.45	1.89
3.048 (120")	1.829	2.438	4.74	8.11	2.33	2.91	3.59	4.91	8.05	13.20	13.13	20.98	2.28
3.810 (150")	2.286	3.048	5.94	10.15	2.93	3.65	4.50	6.15	10.09	16.53	16.47	26.28	2.86
5.080 (200")	3.048	4.064	7.94	13.55	3.92	4.88	6.02	8.21	13.49	22.08	22.03	35.11	3.83
6.350 (250")	3.810	5.080	9.94	16.95	4.91	6.11	7.53	10.28	16.90	27.62	27.58	43.94	4.80
7.620 (300")	4.572	6.096	11.94	20.34	5.91	7.34	9.05	12.35	20.30	33.17	33.14	52.77	5.78
8.890 (350")	5.334	7.112	13.93	23.74	6.90	8.57	10.57	14.41	23.70	38.72	38.70	61.60	6.75
10.160 (400")	6.096	8.128	15.93	27.14	7.89	9.80	12.09	16.48	27.10	44.27	44.26	70.43	7.72

Projection lens Model No.			Standard zoom lens/ ET-ELS20/ET-ELW20/ ET-ELT22/ET-ELT23	ET-ELW22	ET-ELW21 (Fixed)
Projected image size			Height position (H) ²		
Diagonal (SD)	Height (SH)	Width (SW)			
1.016 (40")	0.610	0.813	-0.10 - 0.71	—	0.30
1.270 (50")	0.762	1.016	-0.13 - 0.89	—	0.38
1.524 (60")	0.914	1.219	-0.16 - 1.07	-0.09 - 1.01	0.46
1.778 (70")	1.067	1.422	-0.18 - 1.25	-0.11 - 1.17	0.53
2.032 (80")	1.219	1.626	-0.21 - 1.43	-0.12 - 1.34	0.61
2.286 (90")	1.372	1.829	-0.23 - 1.60	-0.14 - 1.51	0.69
2.540 (100")	1.524	2.032	-0.26 - 1.78	-0.15 - 1.68	0.76
3.048 (120")	1.829	2.438	-0.31 - 2.14	-0.18 - 2.01	0.91
3.810 (150")	2.286	3.048	-0.39 - 2.67	-0.23 - 2.51	1.14
5.080 (200")	3.048	4.064	-0.52 - 3.57	-0.30 - 3.35	1.52
6.350 (250")	3.810	5.080	-0.65 - 4.46	-0.38 - 4.19	1.91
7.620 (300")	4.572	6.096	-0.78 - 5.35	-0.46 - 5.03	2.29
8.890 (350")	5.334	7.112	-0.91 - 6.24	-0.53 - 5.87	2.67
10.160 (400")	6.096	8.128	-1.04 - 7.13	-0.61 - 6.71	3.05

*1 The throw ratio is based on the value during projection of 2.03 m (80") projected image size.

*2 When the Fixed-focus Lens (Model No.: ET-ELW21) is attached, the lens shift is not possible, therefore the height position (H) becomes SH/2.

Formula for calculating the projection distance per projection lens

To use a projected image size not listed in this manual, check the projected image size SD (m) and use the respective formula to calculate projection distance.

All the units for the formula are m. (Value obtained by the following calculation formula contains a slight error.)

When calculating a projection distance using image size designation (value in inches), multiply the value in inches by 0.0254 and substitute it into SD in the formula for calculating the projection distance.

■ Zoom Lens

Projection lens Model No.	Throw ratio	Aspect ratio	Projection distance (L) formula	
			Min. (LW)	Max. (LT)
Standard zoom lens/ET-ELS20	1.61 - 2.76:1	16:10	= 1.389961 x SD - 0.054882	= 2.363976 x SD - 0.048228
	1.61 - 2.76:1	16:9	= 1.428602 x SD - 0.054882	= 2.429695 x SD - 0.048228
	1.93 - 3.32:1	4:3	= 1.573583 x SD - 0.054882	= 2.676260 x SD - 0.048228
ET-ELW22	0.786 - 0.983:1	16:10	= 0.690394 x SD - 0.048460	= 0.855787 x SD - 0.045477
	0.787 - 0.984:1	16:9	= 0.709587 x SD - 0.048460	= 0.879578 x SD - 0.045477
	0.947 - 1.18:1	4:3	= 0.781595 x SD - 0.048460	= 0.968837 x SD - 0.045477
ET-ELW20	1.21 - 1.66:1	16:10	= 1.055748 x SD - 0.055497	= 1.437441 x SD - 0.053400
	1.21 - 1.66:1	16:9	= 1.085098 x SD - 0.055497	= 1.477402 x SD - 0.053400
	1.46 - 2.00:1	4:3	= 1.195197 x SD - 0.055497	= 1.627323 x SD - 0.053400
ET-ELT22	2.72 - 4.48:1	16:10	= 2.366220 x SD - 0.114022	= 3.858307 x SD - 0.112874
	2.73 - 4.49:1	16:9	= 2.432001 x SD - 0.114022	= 3.965568 x SD - 0.112874
	3.28 - 5.39:1	4:3	= 2.678780 x SD - 0.114022	= 4.367992 x SD - 0.112874
ET-ELT23	4.44 - 7.12:1	16:10	= 3.866693 x SD - 0.212284	= 6.141575 x SD - 0.210772
	4.44 - 7.12:1	16:9	= 3.974187 x SD - 0.212284	= 6.312311 x SD - 0.210772
	5.34 - 8.56:1	4:3	= 4.377480 x SD - 0.212284	= 6.952874 x SD - 0.210772

■ Fixed-focus Lens (Model No.: ET-ELW21)

Projection lens Model No.	Throw ratio	Aspect ratio	Projection distance (L) formula
ET-ELW21	0.764:1	16:10	= 0.676299 x SD - 0.057678
	0.765:1	16:9	= 0.695100 x SD - 0.057678
	0.922:1	4:3	= 0.765630 x SD - 0.057678

Removing/attaching the projection lens

Removing and attaching methods of the projection lens are same for standard zoom lenses and optional lenses. Move the lens position to the home position before replacing or removing the projection lens. (➡ page 64)

Attention

- Do not attach or remove the projection lens while the projector is installed to a ceiling or in a high location.
- Replace the projection lens after turning off the projector.
- Do not touch the electric contacts of the projection lens. Dust or dirt may cause poor contact.
- Do not touch the surface of the projection lens with your bare hands.
- Do not turn the gear of the projection lens by hand. Doing so may damage the motor.
- Before attaching the projection lens, remove the lens cover attached to the projection lens.
- Panasonic Connect Co., Ltd. takes no responsibility for any damage or malfunction of the product resulting from the use of projection lenses which are not manufactured by Panasonic Connect Co., Ltd. Always use the standard zoom lens supplied with the projector or the specified projection lens.

Note

- For the adjustment procedure of the focus, zoom, and lens shift after attaching the projector lens, refer to “Adjusting the focus, zoom, and lens shift” (➡ page 63).

Removing the projection lens

Remove the projection lens using the following procedure.

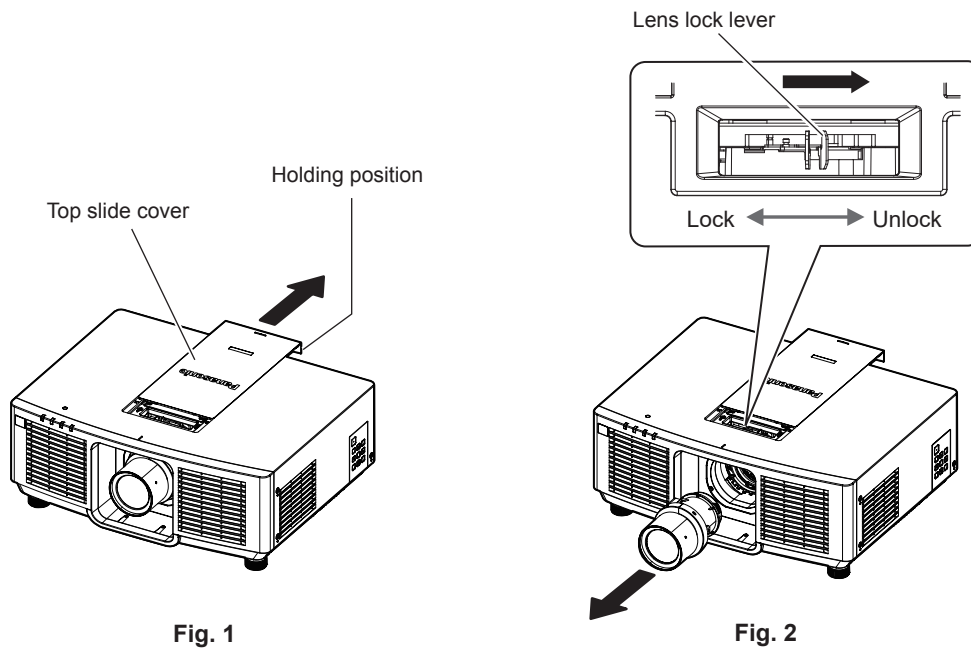

Fig. 1

Fig. 2

- 1) **Slide the top slide cover. (Fig. 1)**
 - Slide the top slide cover until you can pinch the lens lock lever.
- 2) **While holding the projection lens, pinch the lens lock lever and turn to the UNLOCK side. (Fig. 2)**
- 3) **Take out the projection lens straight. (Fig. 2)**

Attention

- Store the removed projection lens where it will be free from vibration and impact.

Attaching the projection lens

Attach the projection lens using the following procedure.

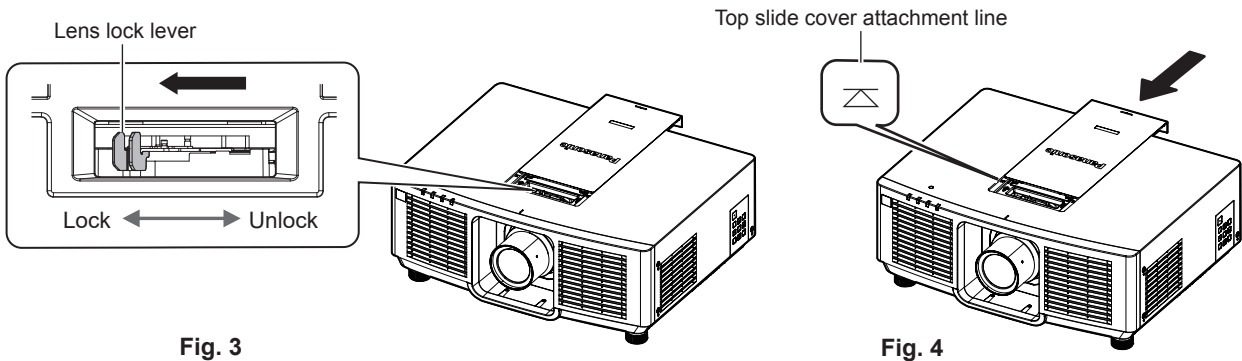
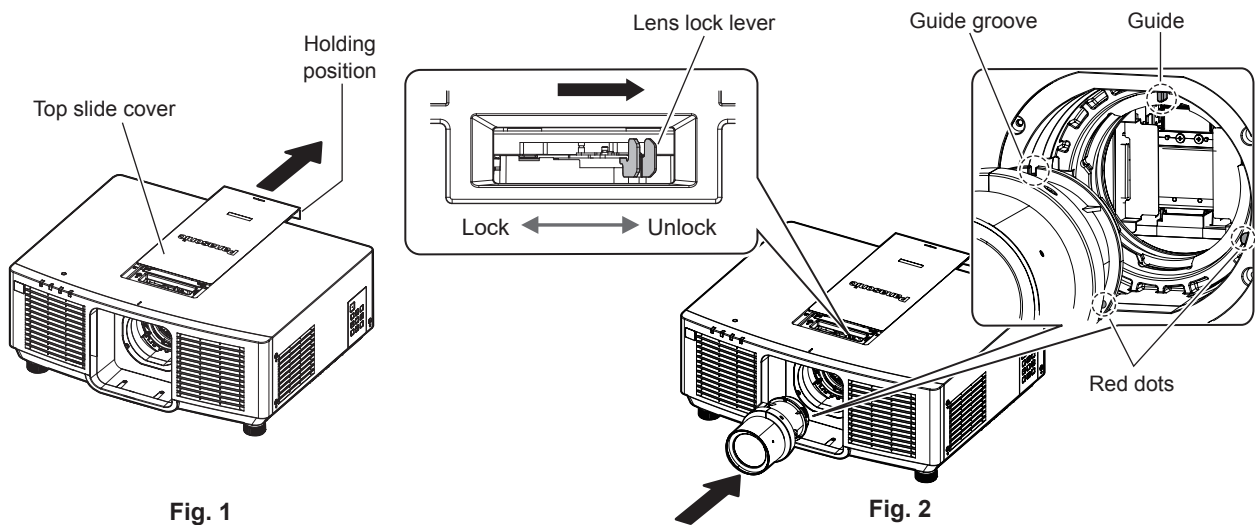

- 1) **Slide the top slide cover. (Fig. 1)**
 - Slide the top slide cover until you can pinch the lens lock lever.
- 2) **Confirm that the lens lock lever is positioned at the UNLOCK side. (Fig. 2)**
 - If the lens lock lever is at the LOCK side (Fig. 3), pinch the lens lock lever and turn to the UNLOCK side. (Fig. 2)
- 3) **Align the mark (red dot) on the projection lens with the mark (red dot) on the projector, and insert the projection lens all the way in. (Fig. 2)**
 - When the mark (red dot) on the projection lens is aligned with the mark (red dot) on the projector, the projection lens guide groove is aligned with the guide of the projector.
- 4) **While holding the projection lens, turn the lock lever fully to the LOCK side. (Fig. 3)**
 - Make sure to fully turn the lens lock lever.
 - The lock lever is split when the projection lens is locked.
- 5) **Attach the top slide cover. (Fig. 4)**
 - Align the top slide cover with the top slide cover attachment line, and attach it by sliding.

Attention

- When installing the projector to a ceiling or in a high location, install the projector after attaching the projection lens to the projector.
- After replacing the projection lens, turn on the projector and confirm the [PROJECTOR SETUP] menu → [LENS] → [LENS TYPE] setting. Change the setting if the type does not match the projection lens attached to the projector. (➡ pages 64, 120)

Connecting

Before connecting

- Before connecting, carefully read the operating instructions for the external device to be connected.
- Turn off the power of all devices before connecting cables.
- Take note of the following points before connecting the cables. Failure to do so may result in malfunctions.
 - When connecting a cable to a device connected to the projector or the projector itself, touch any nearby metallic objects to eliminate static electricity from your body before performing work.
 - Do not use unnecessarily long cables to connect a device to the projector or to the projector body. The longer the cable, the more susceptible to noise it becomes. Since using a cable while it is wound makes it act like an antenna, it is more susceptible to noise.
 - When connecting cables, connect GND first, then insert the connecting terminal of the connecting device in a straight manner.
- Acquire any connection cable necessary to connect the external device to the system that is neither supplied with the device nor available as an option.
- If video signals from video equipment contain too much jitter, the images on the screen may wobble. In this case, a time base corrector (TBC) must be connected.
- If synchronization signals output from computers or video equipment are disrupted due to changes in the video output setting or other reasons, colors of projected images may be temporarily disrupted.
- The signal that can be connected to the projector is YC_BCR/YP_BPR signal, analog RGB signal (synchronization signal is TTL level), and digital signal.
- Some computer models or graphic cards are not compatible with the projector.
- Use a cable compensator when you connect devices to the projector using long cables. Otherwise the projector may not project the image properly.
- For details of the types of video signals that can be used with the projector, refer to “List of compatible signals” (➔ page 205).

Connecting example: AV equipment

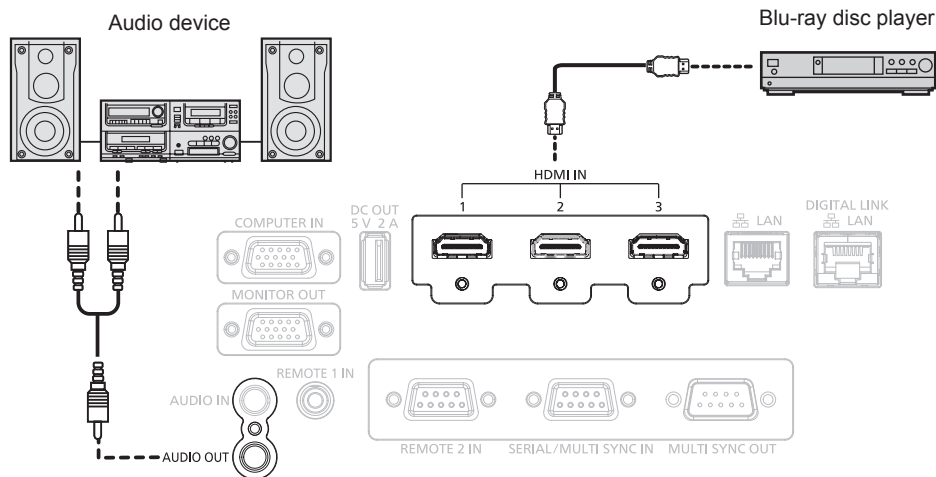

Note

- Switching of the setting in the [DISPLAY OPTION] menu → [HDMI IN] → [EDID SELECT] may be required depending on the connected external device when HDMI signal is input.
- For the HDMI cable, use an HDMI High Speed cable that conforms to the HDMI standards. However, when the following 4K video signal exceeding the supported transmission speed of the HDMI High Speed cable is to be input, use the HDMI cable supporting the high speed transmission of 18 Gbps such as the one with Premium HDMI cable authentication.
 - A video signal with high specification color depth and gradation such as 3840 x 2160/60p 4:2:2/36-bit or 3840 x 2160/60p 4:4:4/24-bit Images may be disrupted or may not be projected when a video signal exceeding the supported transmission speed of the HDMI cable is input.
- The <HDMI IN 1>/<HDMI IN 2>/<HDMI IN 3> terminals can be connected to an external device with the DVI-D terminal by using an HDMI/DVI conversion cable. However, this may not function properly for some external devices, and image may not be projected.

Connecting example: Computers

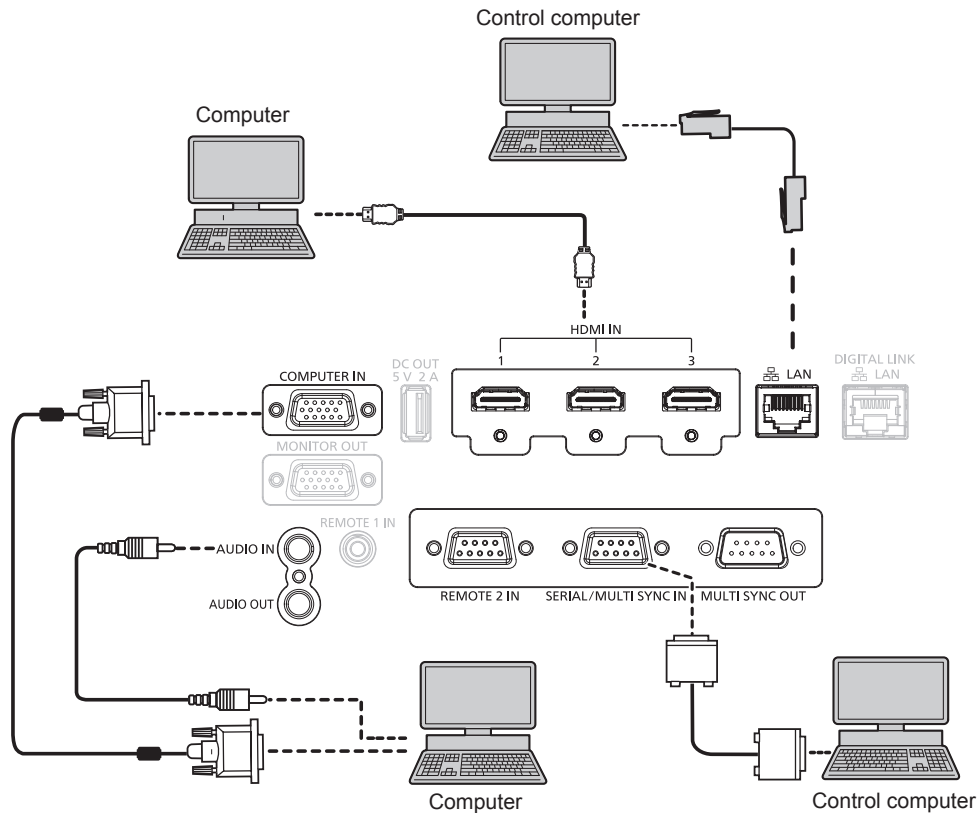

Attention

- When connecting the projector to a computer or an external device, use the power cord supplied with each device and commercially available shielded cables.

Note

- Switching of the setting in the [DISPLAY OPTION] menu → [HDMI IN] → [EDID SELECT] may be required depending on the connected external device when HDMI signal is input.
- For the HDMI cable, use an HDMI High Speed cable that conforms to the HDMI standards. However, when the following 4K video signal exceeding the supported transmission speed of the HDMI High Speed cable is to be input, use the HDMI cable supporting the high speed transmission of 18 Gbps such as the one with Premium HDMI cable authentication.
 - A video signal with high specification color depth and gradation such as 3840 x 2160/60p 4:2:2/36-bit or 3840 x 2160/60p 4:4:4/24-bit Images may be disrupted or may not be projected when a video signal exceeding the supported transmission speed of the HDMI cable is input.
- The <HDMI IN 1>/<HDMI IN 2>/<HDMI IN 3> terminals can be connected to an external device with the DVI-D terminal by using an HDMI/DVI conversion cable. However, this may not function properly for some external devices, and image may not be projected.
- If you operate the projector using the computer with the resume feature (last memory), you may have to reset the resume feature to operate the projector.

Connecting example using DIGITAL LINK

Twisted-pair-cable transmitter based on the communication standard HDBaseT™ such as the optional DIGITAL LINK output supported device (Model No.: ET-YFB100G, ET-YFB200G) uses the twisted pair cable to transmit input images, audio, Ethernet, and serial control signal, and the projector can input such digital signal to the <DIGITAL LINK/LAN> terminal.

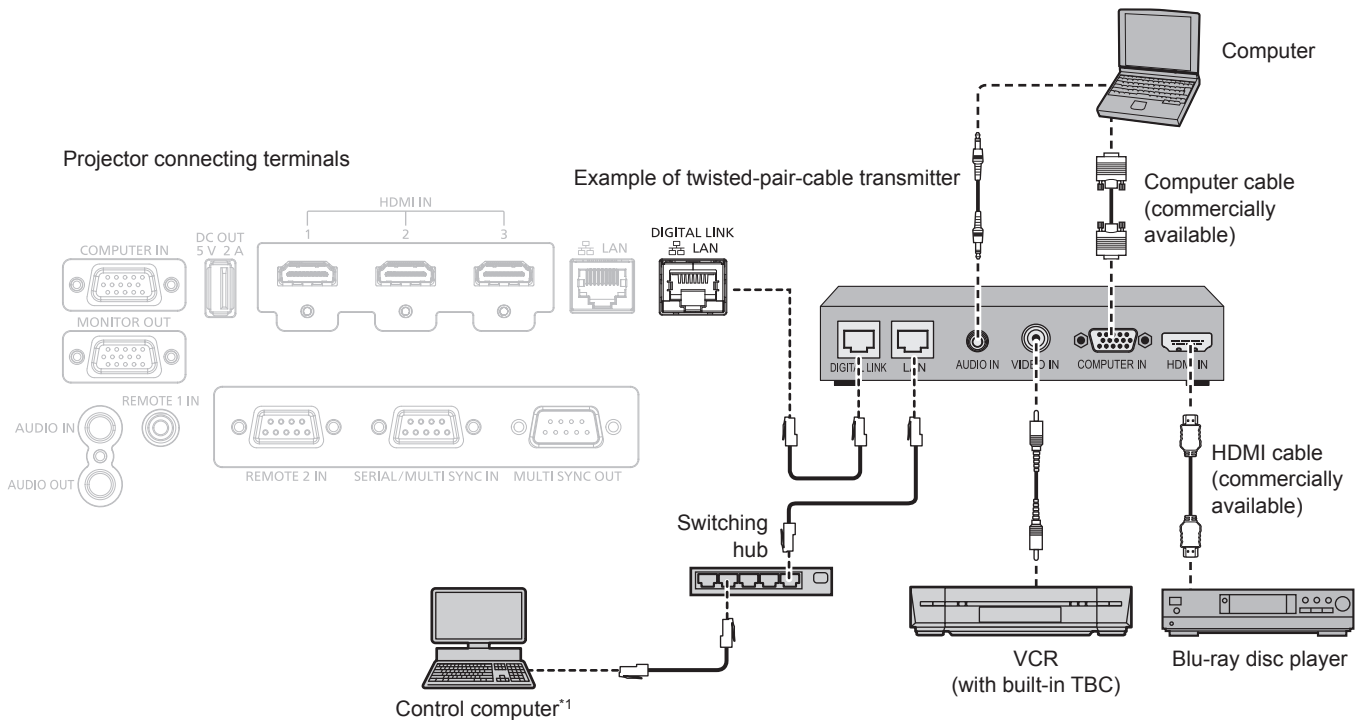

*1 Control target is the projector or the twisted-pair-cable transmitter. The control itself may not be possible depending on the twisted-pair-cable transmitter. Check the operating instructions of the device to be connected.

Attention

- Always use one of the following when connecting a VCR.
 - Use a VCR with built-in time base corrector (TBC).
 - Use a time base corrector (TBC) between the projector and the VCR.
- The image may be disrupted when nonstandard burst signal is connected. In such a case, connect the time base corrector (TBC) between the projector and the external devices.
- Ask a qualified technician or your dealer to install the cable wiring between the twisted-pair-cable transmitter and the projector. Image may be disrupted if cable transmission characteristics cannot be obtained due to inadequate installation.
- For the LAN cable between the twisted-pair-cable transmitter and the projector, use a cable that meets the following criteria:
 - Conforming to CAT5e or higher standards
 - Shielded type (including connectors)
 - Straight-through
 - Single wire
 - Diameter of the cable core is same or larger than AWG24 (AWG24, AWG23, etc.)
- When laying cables between the twisted-pair-cable transmitter and the projector, confirm that cable characteristics are compatible with CAT5e or higher using tools such as a cable tester or cable analyzer. When a relay connector is used, include it in the measurement.
- Do not use a switching hub between the twisted-pair-cable transmitter and the projector.
- When connecting to the projector using a twisted-pair-cable transmitter (receiver) of other manufacturers, do not place another twisted-pair-cable transmitter between the twisted-pair-cable transmitter of other manufacturers and the projector. This may cause image to be disrupted.
- To transmit the Ethernet and serial control signals using the <DIGITAL LINK/LAN> terminal, set the [NETWORK] menu → [ETHERNET TYPE] to [DIGITAL LINK] or [LAN & DIGITAL LINK].
- To transmit the Ethernet signal using the <LAN> terminal, set the [NETWORK] menu → [ETHERNET TYPE] to [LAN] or [LAN & DIGITAL LINK].
- The <DIGITAL LINK/LAN> terminal and the <LAN> terminal are connected inside of the projector when the [NETWORK] menu → [ETHERNET TYPE] is set to [LAN & DIGITAL LINK]. Do not directly connect the <DIGITAL LINK/LAN> terminal and the <LAN> terminal using a LAN cable. Construct the system so that it is not connected to the same network via the peripherals such as the switching hub or the twisted-pair-cable transmitter.
- Do not pull cables forcefully. Also, do not bend or fold cables unnecessarily.
- To reduce the effects of noise as much as possible, stretch out the cables between the twisted-pair-cable transmitter and the projector without any loops.
- Lay the cables between the twisted-pair-cable transmitter and the projector away from other cables, particularly power cables.
- When laying multiple cables, run them side by side along the shortest distance possible without bundling them together.
- After laying the cable, confirm that the value of [SIGNAL QUALITY] in the [NETWORK] menu → [DIGITAL LINK] → [DIGITAL LINK STATUS] is displayed in green, which indicates a normal quality. (➡ page 138)

Note

- Switching of the setting in the [DISPLAY OPTION] menu → [DIGITAL LINK IN] → [EDID SELECT] may be required depending on the connected external device when DIGITAL LINK signal is input.
- For the HDMI cable, use an HDMI High Speed cable that conforms to the HDMI standards. If a cable that does not conform to the HDMI standards is used, images may be interrupted or may not be projected.
- The optional Digital Interface Box (Model No.: ET-YFB100G) and the optional DIGITAL LINK Switcher (Model No.: ET-YFB200G) do not support the input and output of the 4K video signal.
- The maximum transmission distance between the twisted-pair-cable transmitter and the projector is 100 m (328'1") for the signal with resolution of 1 920 x 1 200 dots or less. For the signal with the resolution exceeding 1 920 x 1 200 dots, the maximum transmission distance will be 50 m (164'1"). It is possible to transmit up to 150 m (492'2") if the twisted-pair-cable transmitter supports the long-reach communication method. However, the signal that the projector can receive is only up to 1080/60p (1 920 x 1 080 dots, dot clock frequency 148.5 MHz) for the long-reach communication method. If this distance is exceeded, image may be disrupted or a malfunction may occur in LAN communication. Please note that Panasonic Connect Co., Ltd. does not support the use of the projector outside the maximum transmission distance. When connecting with the long reach, video signal or distance that can be transmitted may be restricted, depending on the specification of the twisted-pair-cable transmitter.
- For twisted-pair-cable transmitters of other manufacturers that the operation has been verified with this projector, visit the website (<https://panasonic.net/cns/projector/>). Note that the verification for devices of other manufacturers has been made for the items set by Panasonic Connect Co., Ltd., and not all the operations have been verified. For operation or performance problems caused by the devices of other manufacturers, contact the respective manufacturers.

Connecting example when using the contrast synchronization function/shutter synchronization function

In a case to construct a multi-display by linking projected images from multiple projectors, following functions can be used by synchronizing multiple projectors using the <SERIAL/MULTI SYNC IN> terminal and the <MULTI SYNC OUT> terminal.

• Contrast synchronization function

A linked screen with balanced contrast can be displayed by sharing the brightness level of the video signal being input to each projector.

To use this function, set the [PROJECTOR SETUP] menu → [MULTI PROJECTOR SYNC] for each synchronized projector as follows.

- Set [MULTI PROJECTOR SYNC] → [MODE] to anything other than [OFF].
Set [MODE] to [MAIN] only on one projector that is synchronized. Set [MODE] to [SUB] for all other projectors.
- Set [MULTI PROJECTOR SYNC] → [CONTRAST SYNC] to [ON].

• Shutter synchronization function

This is a function to synchronize the shutter operation of the specified projector to other projectors, and the effect using the shutter function including the fade out/fade in operation can be synchronized.

To use this function, set the [PROJECTOR SETUP] menu → [MULTI PROJECTOR SYNC] for each synchronized projector as follows.

- Set [MULTI PROJECTOR SYNC] → [MODE] to anything other than [OFF].
Set [MODE] to [MAIN] only on one projector that becomes the synchronization source within the linked projectors. Set [MODE] to [SUB] for all other projectors.
- Set [MULTI PROJECTOR SYNC] → [SHUTTER SYNC] to [ON].

Connecting example

Connect all the projectors to be linked in a loop by daisy chain connection when using the contrast synchronization function/shutter synchronization function. The number of linked projectors is limited to the maximum of 64 projectors.

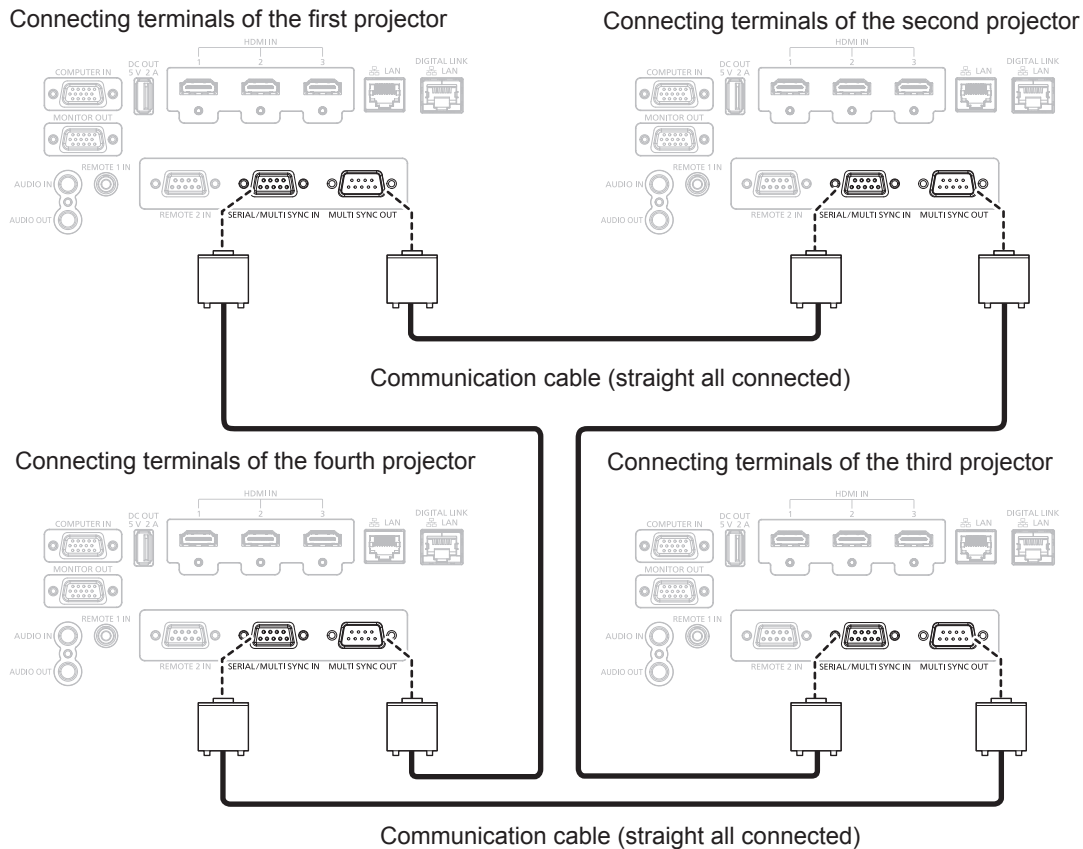

Note

- The contrast synchronization function and the shutter synchronization function can be used simultaneously.
- For details on the settings of the contrast synchronization function and the shutter synchronization function, refer to the [PROJECTOR SETUP] menu → [MULTI PROJECTOR SYNC] (➔ page 116).
- If there are any projectors which you do not want to synchronize within the linked projectors, set [CONTRAST SYNC] and [SHUTTER SYNC] to [OFF] individually.

Chapter 3 Basic Operations

This chapter describes basic operations to start with.

Switching on/off the projector

Connecting the power cord

Make sure that the supplied power cord is securely fixed to the <AC IN> terminal of the projector body to prevent it from being removed easily.

Confirm that the <MAIN POWER> switch is on the <OFF> side before connecting the supplied power cord to the projector.

Use the power cord matching with the power supply voltage and the shape of the outlet.

For details of power cord handling, refer to “Read this first!” (➔ page 5).

Note

- The supplied power cords vary depending on the country or region where you purchased the product.

How to attach the power cord

Power cord holder

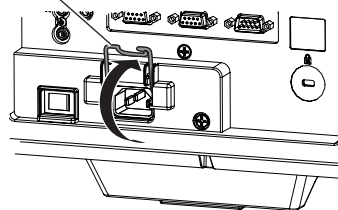

Fig.1

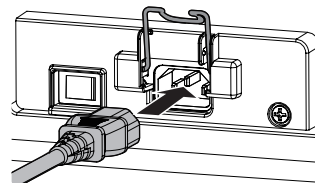

Fig.2

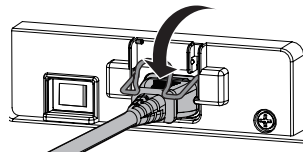

Fig.3

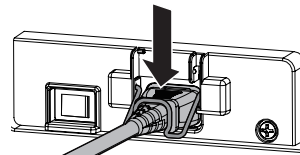

Fig.4

- 1) Confirm that the power cord holder is raised so that the power cord can be inserted. (Fig. 1)
- 2) Check the shapes of the <AC IN> terminal on the back of the projector and the power cord connector, then insert the connector completely in the correct direction. (Fig. 2)
- 3) Lower the power cord holder. (Fig. 3)
- 4) Press down the power cord holder until the end of the power cord holder snaps onto the power cord to secure the power cord. (Fig. 4)
 - When pressing down and snapping the power cord holder onto the power cord, hold the power cord from the opposite side to avoid excessive force to be applied on the <AC IN> terminal.

How to remove the power cord

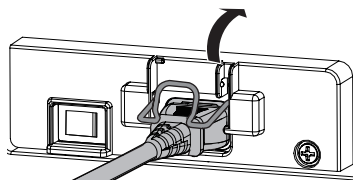

Fig.1

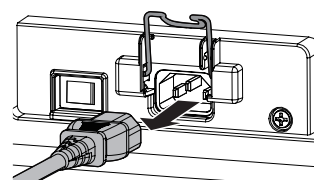
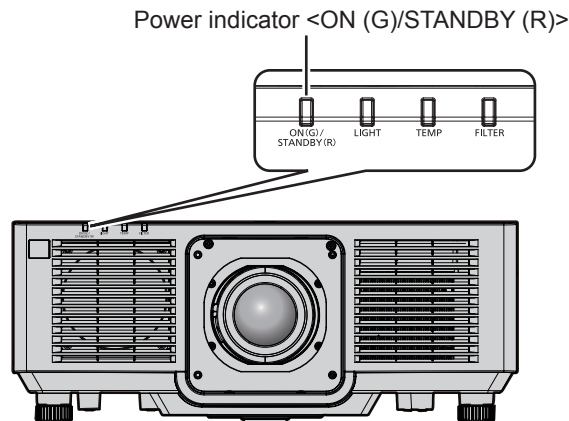

Fig.2

- 1) Confirm that the <MAIN POWER> switch on the back of the projector is on the <OFF> side, and remove the power plug from the outlet.
- 2) Raise the power cord holder fixing the power cord upward. (Fig. 1)
 - Fix the power cord holder by snapping into the projector.
- 3) While holding the power cord connector, pull out the power cord from the <AC IN> terminal of the projector. (Fig. 2)

Power indicator

Indicate the status of the power. Check the status of the power indicator <ON (G)/STANDBY (R)> before operating the projector.



Indicator status		Projector status
Off		The main power is switched off.
Red	Lit	<p>The power is switched off. (standby mode) Projection will start when the power <ϕ/ > button is pressed.</p> <ul style="list-style-type: none"> The setting of the projector is as follows. <ul style="list-style-type: none"> The [PROJECTOR SETUP] menu → [ECO MANAGEMENT] → [QUICK STARTUP] is set to [OFF] The [PROJECTOR SETUP] menu → [AUDIO SETTING] → [IN STANDBY MODE] is set to [OFF] The projector may not operate when the light source indicator <LIGHT> or the temperature indicator <TEMP> is blinking. (➡ page 175)
	Blinking	<p>The power is switched off. (standby mode) Projection will start when the power <ϕ/ > button is pressed.</p> <ul style="list-style-type: none"> The projector is set to one of the following. Power consumption is high. <ul style="list-style-type: none"> The [PROJECTOR SETUP] menu → [ECO MANAGEMENT] → [QUICK STARTUP] is set to [ON] The [PROJECTOR SETUP] menu → [AUDIO SETTING] → [IN STANDBY MODE] is set to [ON] The indicator will change to a red light when the specified time has elapsed after the projector enters the standby mode if the projector is set as following. The specified time is a time set in the [PROJECTOR SETUP] menu → [ECO MANAGEMENT] → [QUICK STARTUP] → [VALID PERIOD]. <ul style="list-style-type: none"> The [PROJECTOR SETUP] menu → [ECO MANAGEMENT] → [QUICK STARTUP] is set to [ON] The [PROJECTOR SETUP] menu → [AUDIO SETTING] → [IN STANDBY MODE] is set to [OFF] The projector may not operate when the light source indicator <LIGHT> or the temperature indicator <TEMP> is blinking. (➡ page 175)
Green	Lit	Projecting.
Orange	Lit	The projector is preparing to switch off the projector. The power is switched off after a while. (Changes to the standby mode.)

Note

- While the power indicator <ON (G)/STANDBY (R)> lights orange, the fan is running to cool the projector.
- For approximately five seconds after the projector is turned off, the indicator does not light up even if the power is turned on. Turn on the power again after the power indicator <ON (G)/STANDBY (R)> lights/blinks red.
- The projector consumes power even in standby mode (power indicator <ON (G)/STANDBY (R)> lights/blinks red). Refer to “Standby mode power consumption” (➡ page 202) for the power consumption.
- The power indicator <ON (G)/STANDBY (R)> will blink if the projector receives a remote control signal.
- The power indicator <ON (G)/STANDBY (R)> will blink green slowly while the shutter function is in use (shutter: closed).

Switching on the projector

When using the optional projection lens, attach the projection lens before switching on the projector.
Remove the lens cover first.

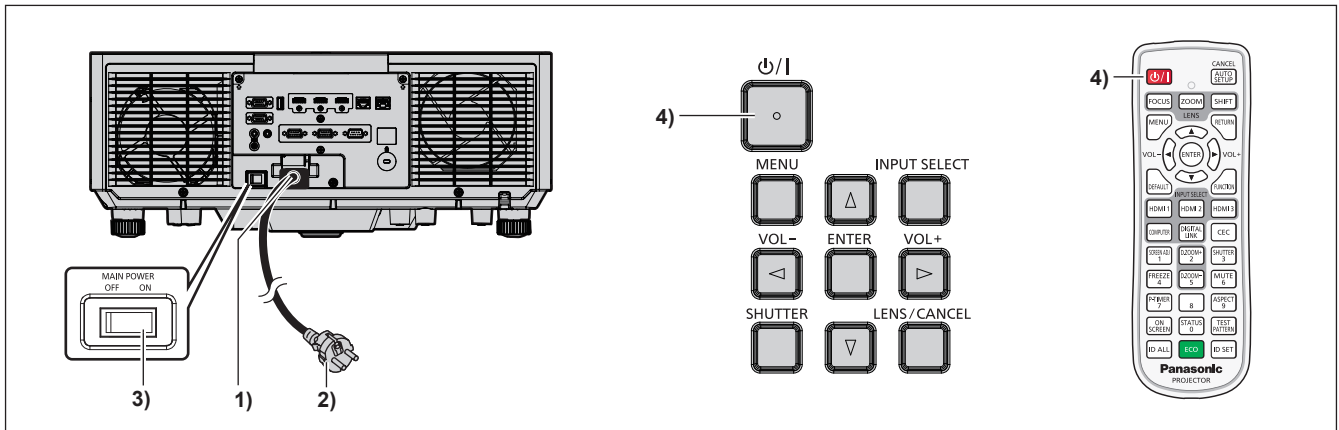

- 1) **Connect the power cord to the projector.**
- 2) **Connect the power plug to an outlet.**
- 3) **Press the <ON> side of the <MAIN POWER> switch to turn on the power.**
 - The power indicator <ON (G)/STANDBY (R)> lights/blinks red, and the projector enters the standby mode.
- 4) **Press the power <⏻/|> button.**
 - The power indicator <ON (G)/STANDBY (R)> lights green and the image is soon projected on the screen.

Note

- When the [PROJECTOR SETUP] menu → [ECO MANAGEMENT] → [STANDBY MODE] is set to [ECO], it takes longer for the projection to start after the power is turned on, compared to when set to [NORMAL].
- When the [PROJECTOR SETUP] menu → [ECO MANAGEMENT] → [QUICK STARTUP] is set to [ON], and the power is turned on before the specified time elapses after the projector enters the standby mode, an image will be projected approximately one second after the power is turned on.
The specified time is a time set in the [PROJECTOR SETUP] menu → [ECO MANAGEMENT] → [QUICK STARTUP] → [VALID PERIOD].
- When the power is turned on or an input signal is switched, you may here a high-frequency driving sound. This is not a malfunction.
- If the power was turned off at the previous use by pressing the <OFF> side of the <MAIN POWER> switch or by using the breaker directly while projecting, the power indicator <ON (G)/STANDBY (R)> lights green and an image is projected after a while when the power is turned on by pressing the <ON> side of the <MAIN POWER> switch or by turning the breaker on with the power plug connected to the outlet. This applies only when the [PROJECTOR SETUP] menu → [INITIAL STARTUP] is set to [LAST MEMORY].

When the initial setting screen is displayed

When the projector is switched on for the first time after purchase, as well as when the [PROJECTOR SETUP] menu → [INITIALIZE] → [ALL USER DATA] is executed, the focus adjustment screen is displayed after projection starts, and then the **[INITIAL SETTING]** screen is displayed followed by the **[ADMINISTRATOR ACCOUNT]** screen. When the [PROJECTOR SETUP] menu → [INITIALIZE] → [NETWORK/E-MAIL] is executed, the **[ADMINISTRATOR ACCOUNT]** screen is displayed after projection starts.

In other occasions, you can change the settings by menu operations.

If you press the <MENU> button while the **[INITIAL SETTING]** screen is displayed, you can go back to the previous screen.

Same operation is available by pressing the <RETURN> button.

Focus adjustment

Adjust the focus to display the menu screen clearly.

Adjustment of the zoom and shift may also be necessary.

For details, refer to “Adjusting the focus, zoom, and lens shift” (➔ page 63).

- 1) Press ▲▼◀▶ to adjust the focus.



- 2) Press the <MENU> button to proceed to the initial setting.

Initial setting (display language)

Select the language to show on the screen.

After completed the initial setting, you can change the display language from the [DISPLAY LANGUAGE] menu.

- 1) Press ▲▼◀▶ to select the display language.

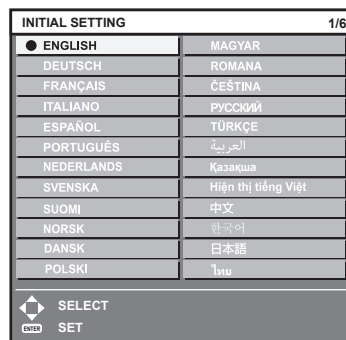

- 2) Press the <ENTER> button to proceed to the initial setting.

Initial setting (installation setting)

Set [FRONT/REAR] and [FLOOR/CEILING] in [PROJECTION METHOD] depending on the installation mode. Refer to “Installation mode” (➔ page 36) for details.

After completed the initial setting, you can change the setting from the [PROJECTOR SETUP] menu → [PROJECTION METHOD].

1) Press ◀▶ to switch the setting.

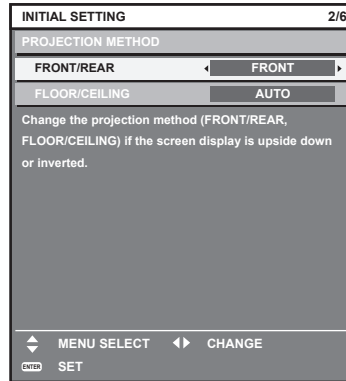

2) Press the <ENTER> button to proceed to the initial setting.

Initial setting (standby mode)

Set the operation mode during standby. The factory default setting is [NORMAL], which allows you to use the network function during standby. To keep power consumption low during standby, set this item to [ECO].

After completed the initial setting, you can change the setting from the [PROJECTOR SETUP] menu → [ECO MANAGEMENT] → [STANDBY MODE].

1) Press ◀▶ to switch the setting.

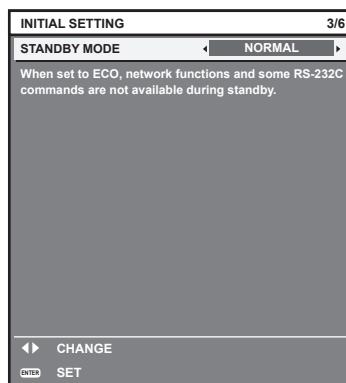

2) Press the <ENTER> button to proceed to the initial setting.

Note

- The preceding initial setting screen is displayed when the projector is switched on for the first time after purchase. When the [PROJECTOR SETUP] menu → [INITIALIZE] → [ALL USER DATA] is executed, the [STANDBY MODE] setting before executing is displayed.

Initial setting (screen setting)

Set the screen format (aspect ratio) and display position of the image.

After completed the initial setting, you can change the settings of each item from the [DISPLAY OPTION] menu → [SCREEN SETTING].

1) Press ◀▶ to switch the setting.

- Proceed to Step 4) when [16:10] is selected.

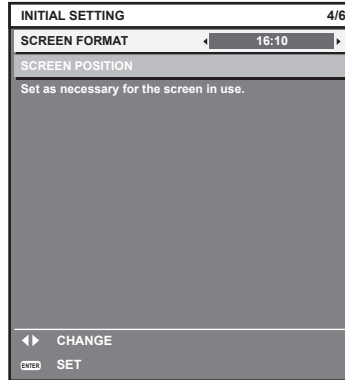

2) Press ▲▼ to select [SCREEN POSITION].

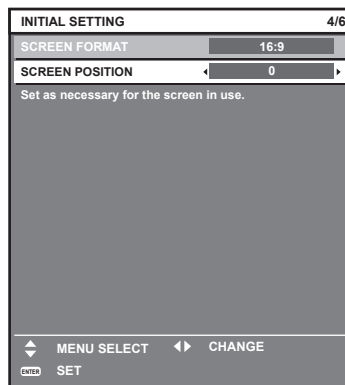

3) Press ◀▶ to adjust.

- The display position can be adjusted vertically when [16:9] is selected in [SCREEN FORMAT], and adjusted horizontally when [4:3] is selected.

4) Press the <ENTER> button to proceed to the initial setting.

Initial setting (time zone)

Set [TIME ZONE] in accordance with the country or region where you use the projector.

After completed the initial setting, you can change the setting from the [PROJECTOR SETUP] menu → [DATE AND TIME]. The current settings are displayed in [LOCAL DATE] and [LOCAL TIME].

1) Press ◀▶ to switch the setting.

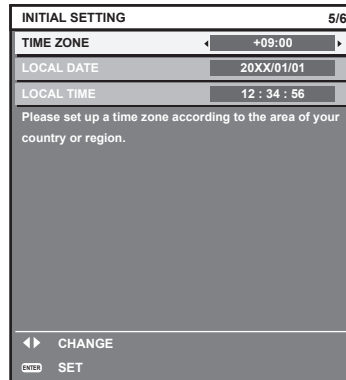

2) Press the <ENTER> button to proceed to the initial setting.

Note

- In the factory default setting, the time zone of the projector is set to +09:00 (Japan and Korea Standard Time). Change the setting of the [PROJECTOR SETUP] menu → [DATE AND TIME] → [TIME ZONE] to the time zone of the region where you use the projector.

Initial setting (date and time)

Set the local date and time. After completed the initial setting, you can change the setting from the [PROJECTOR SETUP] menu → [DATE AND TIME].

To set the date and time automatically, refer to “Setting the date and time automatically” (➡ page 114).

1) Press ▲▼ to select an item.

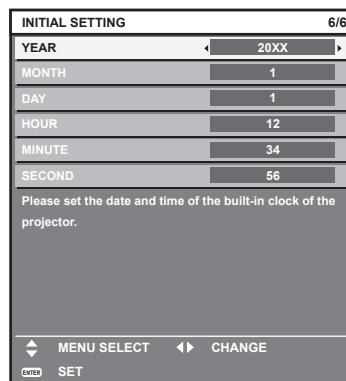

2) Press ◀▶ to switch the setting.

3) Press the <ENTER> button.

- Confirm the setting value and complete the initial setting.

When the administrator account setting screen is displayed

When the projector is switched on for the first time after purchase, as well as when the [PROJECTOR SETUP] menu → [INITIALIZE] → [ALL USER DATA] is executed, the focus adjustment screen is displayed after projection starts, and then the [INITIAL SETTING] screen and the [ADMINISTRATOR ACCOUNT] screen are displayed. When the [PROJECTOR SETUP] menu → [INITIALIZE] → [NETWORK/E-MAIL] is executed, the [ADMINISTRATOR ACCOUNT] screen is displayed after projection starts.

To use the network function of this projector, set the user name and password of the administrator account. You can also set it later from the [NETWORK] menu → [ADMINISTRATOR ACCOUNT].

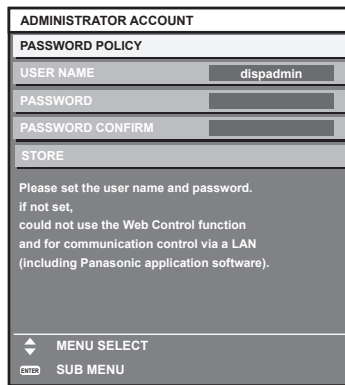

[PASSWORD POLICY]

Displays the policies about the password for the administrator account.

- 1) Press ▲▼ to select [PASSWORD POLICY], and press the <ENTER> button.
 - The [PASSWORD POLICY] screen is displayed.
 - Pressing the <MENU> button can return to the [ADMINISTRATOR ACCOUNT] screen.

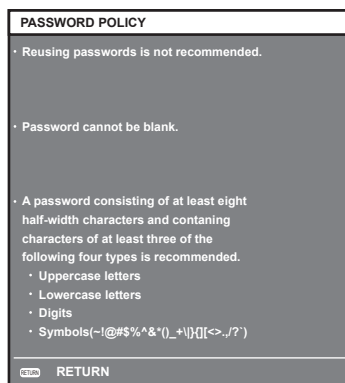

Setting the administrator account

Set the user name and password of the administrator account.

- 1) Press ▲▼ to select [USER NAME], and press the <ENTER> button.
 - The [USER NAME] screen is displayed.
 - The factory default setting of user name is "dispadmin".
- 2) Press ▲▼◀▶ to select a character, and press the <ENTER> button.
 - Up to 16 characters can be entered.
- 3) After entering the user name, press ▲▼◀▶ to select [OK], and press the <ENTER> button.
 - The [ADMINISTRATOR ACCOUNT] screen is displayed.
- 4) Press ▲▼ to select [PASSWORD], and press the <ENTER> button.
 - The [PASSWORD] screen is displayed.
- 5) Press ▲▼◀▶ to select a character, and press the <ENTER> button.
 - Up to 16 characters can be entered.
 - The password cannot be blank.
- 6) After entering the password, press ▲▼◀▶ to select [OK], and press the <ENTER> button.
 - The [ADMINISTRATOR ACCOUNT] screen is displayed.
- 7) Press ▲▼ to select [PASSWORD CONFIRM], and press the <ENTER> button.
 - The [PASSWORD CONFIRM] screen is displayed.
- 8) Enter the password entered in Step 5).

- 9) After entering the password, press ▲▼◀▶ to select [OK], and press the <ENTER> button.
 - The [ADMINISTRATOR ACCOUNT] screen is displayed.
- 10) Press ▲▼ to select [STORE], and press the <ENTER> button.
 - The confirmation screen is displayed.
- 11) Press ▶ to select [OK], and press the <ENTER> button.

Note

- For restrictions on character strings that can be set for password, refer to [PASSWORD POLICY] (➔ page 59).
- By pressing the <MENU> button while the [ADMINISTRATOR ACCOUNT] screen is displayed, you can proceed to the next operation without setting an administrator account password, but the network function of this projector cannot be used. To use the web control function or the communication control (including operation with application software) via LAN, set a password.
- If you press the <MENU> button while the [ADMINISTRATOR ACCOUNT] screen is displayed, the [ADMINISTRATOR ACCOUNT] screen will not be displayed the next time the power is turned on. To use the network function, set a password in the [NETWORK] menu → [ADMINISTRATOR ACCOUNT].
- The user name and password of the administrator account can also be changed on the [Set up password] page (➔ page 162) of the web control screen.
- The user name and password of the standard user account without administrator rights can be set on the [Set up password] page (➔ page 162) of the web control screen.

Making adjustments and selections

It is recommended that images be projected continuously for at least 30 minutes before the focus is adjusted.

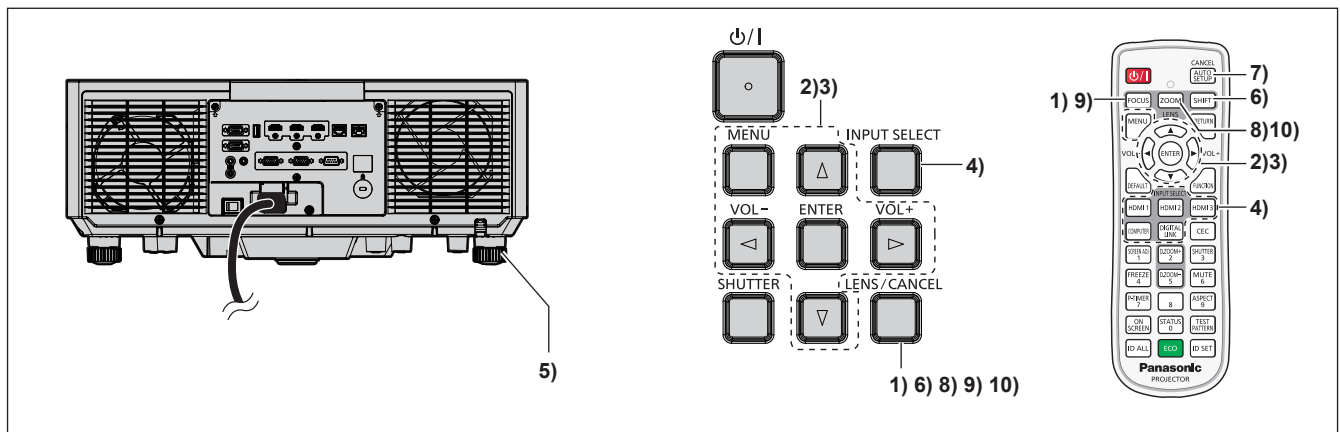

- 1) Press the <FOCUS> button to roughly adjust the focus of the projected image. (➔ page 63)
- 2) Change the setting of the [PROJECTOR SETUP] menu → [PROJECTION METHOD] depending on the installation mode. (➔ page 36)
 - Refer to “Navigating through the menu” (➔ page 74) for the operation of the menu screen.
- 3) Set [LENS TYPE].
 - Confirm the setting of the lens type when using the projector for the first time after replacing the projection lens. (➔ pages 64, 120)
- 4) Select the input by pressing the input selection button on the remote control or the control panel.
 - The buttons that can be used on the remote control or the control panel are as follows.

Remote control:
 <HDMI 1> button, <HDMI 2> button, <HDMI 3> button, <COMPUTER> button, <DIGITAL LINK> button

Control panel:
 <INPUT SELECT> button

 - For details of operation for input selection, refer to “Selecting the input signal” (➔ page 62).
- 5) Adjust the front, back and sideway tilt of the projector with the adjustable feet. (➔ page 65)
- 6) Press the <SHIFT> button to adjust the position of the projected image. (➔ page 63)
- 7) If the input signal is the analog RGB signal, press the <AUTO SETUP/CANCEL> button to automatically adjust the projection position.
- 8) Press the <ZOOM> button to adjust the projected image size to match the screen.

9) Press the <FOCUS> button again to adjust the focus. (➡ page 63)

10) Press the <ZOOM> button again to adjust the zoom to match the projected image size to the screen.

Note

- When the projector is switched on for the first time after purchase, as well as when the [PROJECTOR SETUP] menu → [INITIALIZE] → [ALL USER DATA] is executed, the focus adjustment screen is displayed after projection starts, and then the [INITIAL SETTING] screen is displayed followed by the [ADMINISTRATOR ACCOUNT] screen. When the [PROJECTOR SETUP] menu → [INITIALIZE] → [NETWORK/E-MAIL] is executed, the [ADMINISTRATOR ACCOUNT] screen is displayed after projection starts. For details, refer to “When the initial setting screen is displayed” (➡ page 55) and “When the administrator account setting screen is displayed” (➡ page 58).

Switching off the projector

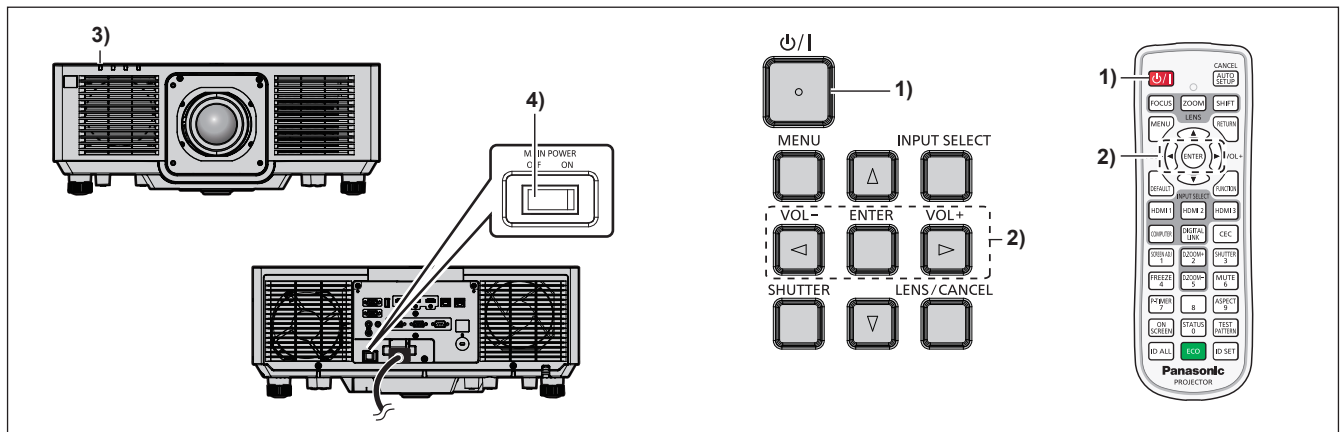

1) Press the power <⏻/|> button.

- The [POWER OFF(STANDBY)] confirmation screen is displayed.

2) Press ◀▶ to select [OK], and press the <ENTER> button.

(Or press the power <⏻/|> button again.)

- Projection of the image will stop, and the power indicator <ON (G)/STANDBY (R)> on the projector body lights orange. (The fan keeps running.)

3) Wait for a few seconds until the power indicator <ON (G)/STANDBY (R)> of the projector body lights/blinks red.

4) Press the <OFF> side of the <MAIN POWER> switch to turn off the power.

Note

- For approximately five seconds after the projector is turned off, the indicator does not light up even if the power is turned on.
- Even when the power <⏻/|> button is pressed and the projector is switched off, the projector consumes power if the main power of the projector is on.
When the [PROJECTOR SETUP] menu → [ECO MANAGEMENT] → [STANDBY MODE] is set to [ECO], use of some functions is restricted, but the power consumption during standby mode can be conserved.
- While projecting, the power can be turned off by pressing the <OFF> side of the <MAIN POWER> switch, or by directly using the breaker under conditions where the <MAIN POWER> switch of the projector cannot be switched off/on easily such as while installing on the ceiling. However, the settings or adjustments performed right before the power is turned off may not be reflected.

Projecting

Check the external device connection (➔ page 46) and the power cord connection (➔ page 52), and turn on the power (➔ page 54) to start projection. Select the image to project, and adjust appearance of the projected image.

Selecting the input signal

The input of the image to project can be switched. Method to switch the input is as follows.

- Press the input selection button on the remote control and directly specify the input of the image to project.
- Press the <INPUT SELECT> button on the control panel to display the input selection screen, and select the input to project from the list.



Switching the input directly with the remote control

The input for projection can be switched by directly specifying it with the input selection button on the remote control.

- 1) Press the input selection button (<HDMI 1>, <HDMI 2>, <HDMI 3>, <COMPUTER>, <DIGITAL LINK>).

<HDMI 1>	Switches the input to HDMI1. The image of the signal input to the <HDMI IN 1> terminal is projected.
<HDMI 2>	Switches the input to HDMI2. The image of the signal input to the <HDMI IN 2> terminal is projected.
<HDMI 3>	Switches the input to HDMI3. The image of the signal input to the <HDMI IN 3> terminal is projected.
<COMPUTER>	Switches the input to COMPUTER. The image of the signal input to the <COMPUTER IN> terminal is projected.
<DIGITAL LINK>	Switches the input to DIGITAL LINK. The image of the signal input to the <DIGITAL LINK/LAN> terminal is projected.

Attention

- Images may not be projected properly depending on the external device, or the Blu-ray disc or DVD disc, to be played back. Set the [PICTURE] menu → [SYSTEM SELECTOR].
- Confirm the aspect ratio of the projection screen and the image, and switch to an optimum aspect ratio from the [POSITION] menu → [ASPECT].

Note

- When the optional DIGITAL LINK output supported device (Model No.: ET-YFB100G, ET-YFB200G) is connected to the <DIGITAL LINK/ LAN> terminal, the input on the DIGITAL LINK output supported device changes each time the <DIGITAL LINK> button is pressed. The input can also be changed using the RS-232C control command. For twisted-pair-cable transmitters of other manufacturers, switch the input on the projector to DIGITAL LINK, and then switch the input on the twisted-pair-cable transmitter.

Switching the input by displaying the input selection screen

The input for projection can be selected by displaying the input selection screen using the <INPUT SELECT> button on the control panel.

- 1) Press the <INPUT SELECT> button on the control panel.

- The input selection screen is displayed.

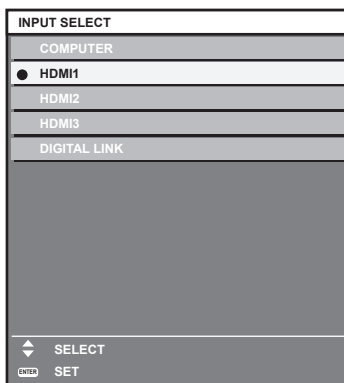

2) Press ▲▼ to select the input for projection, and press the <ENTER> button.

Note

- The input can also be switched by pressing the <INPUT SELECT> button while the input selection screen is displayed. The input will switch each time you press the <INPUT SELECT> button.
- If the optional DIGITAL LINK output supported device (Model No.: ET-YFB100G, ET-YFB200G) is connected to the projector, the input selection menu for the DIGITAL LINK output supported device is displayed when the <ENTER> button is pressed while the DIGITAL LINK input is selected in the input selection screen.
- If the optional DIGITAL LINK output supported device (Model No.: ET-YFB100G, ET-YFB200G) is connected to the projector, the DIGITAL LINK logo and the input name selected in the DIGITAL LINK output supported device are displayed in the display section of the [DIGITAL LINK] in the input selection screen.

Adjusting the focus, zoom, and lens shift

Adjust the focus, zoom, and lens shift if the image projected to the screen or its position is shifted even if the projector and the screen are set up in the correct positions.

Using the control panel

- 1) Press the <LENS/CANCEL> button on the control panel.
 - Pressing the button changes the adjustment screen in the order of [FOCUS], [ZOOM], and [SHIFT].
- 2) Select each adjustment item and press ▲▼◀▶ to adjust.

Using the remote control

- 1) Press the lens buttons (<FOCUS>, <ZOOM>, <SHIFT>) on the remote control.
 - Pressing the <FOCUS> button: Adjusts the focus (adjustment of the lens focus position).
 - Pressing the <ZOOM> button: Adjusts the zoom (adjustment of the lens zoom position).
 - Pressing the <SHIFT> button: Adjusts the lens shift (vertical position and horizontal position of the lens).
- 2) Select each adjustment item and press ▲▼◀▶ to adjust.

CAUTION

During the lens shift operation, do not insert your hand in the opening around the lens.
Your hand may get caught, resulting in an injury.

Note

- The adjustment can be performed faster by holding down ▲▼◀▶ for approximately three seconds or longer.
- It is recommended that images be projected continuously for at least 30 minutes before the focus is adjusted.
- Only [FOCUS] is displayed in yellow so that the displayed menu item can be recognized by color, even when the displayed characters are unreadable due to incorrect focus. (Factory default)
The displayed color for [FOCUS] differs depending on the setting in the [DISPLAY OPTION] menu → [ON-SCREEN DISPLAY] → [OSD COLOR].
- The current position and maximum movable range are displayed with a bar scale during shift adjustment. Also, the red bar indicates the immovable range from current position. The triangular mark under the bar scale indicates the home position.

Setting the lens type

When the projector is used for the first time or when the projection lens is replaced, confirm the [LENS TYPE] setting. Change the setting if the type does not match the projection lens attached to the projector.

- 1) **Press the <MENU> button.**
 - The [MAIN MENU] screen is displayed.
- 2) **Press ▲▼ to select [PROJECTOR SETUP], and press the <ENTER> button.**
 - The [PROJECTOR SETUP] screen is displayed.
- 3) **Press ▲▼ to select [LENS], and press the <ENTER> button.**
 - The [LENS] screen is displayed.
- 4) **Press ▲▼ to select [LENS TYPE], and press the <ENTER> button.**
 - The [LENS TYPE] screen is displayed.
- 5) **Press ▲▼ to select the lens type.**

[ET-ELS20]*1	Select this item when the standard zoom lens or the Zoom Lens (Model No.: ET-ELS20) is attached to the projector.
[ET-ELW21]	Select this item when the Fixed-focus Lens (Model No.: ET-ELW21) is attached to the projector.
[ET-ELW22]	Select this item when the Zoom Lens (Model No.: ET-ELW22) is attached to the projector.
[ET-ELW20]	Select this item when the Zoom Lens (Model No.: ET-ELW20) is attached to the projector.
[ET-ELT22]	Select this item when the Zoom Lens (Model No.: ET-ELT22) is attached to the projector.
[ET-ELT23]	Select this item when the Zoom Lens (Model No.: ET-ELT23) is attached to the projector.

*1 This product is equivalent to the standard zoom lens.

- 6) **Press the <ENTER> button.**
 - The [LENS CALIBRATION] screen is displayed.
- 7) **Press ◀▶ to select [OK], and press the <ENTER> button.**
 - The lens calibration is started.
 - After completing the calibration, the projection lens will move to the home position.
 - To cancel, select [CANCEL]. In this case, the [LENS TYPE] setting is not changed.

Note

- The lens shift range varies depending on the lens type. If [LENS TYPE] is set incorrectly, lens shift range may not be adjusted properly. For details, see "Lens shift range" (➔ page 65).

Moving the lens position to the home position

To move the lens position to the home position, operate in following procedure.

- 1) **Press the <DEFAULT> button on the remote control while the [SHIFT] adjustment screen is displayed.**
 - The [HOME POSITION] screen is displayed.

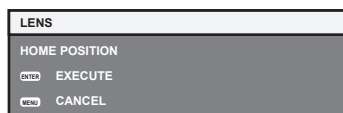

- 2) **Press the <ENTER> button while the [HOME POSITION] screen is displayed (approximately five seconds).**
 - [PROGRESS] is displayed in the [HOME POSITION] screen, and the lens position returns to the home position.

Note

- The home position of the lens is used when the lens is replaced or when the projector is stored, and it is not the optical center of the screen.
- The [HOME POSITION] screen can also be displayed by pressing the <LENS/CANCEL> button on the control panel or the <SHIFT> button on the remote control for three seconds or longer.

Lens shift range

The projector can adjust the position of the projected image within the lens shift range for each projection lens based on the position of the projected image in the home position (standard projection position).

Following illustration indicates the lens shift range when the projector is installed on desk/floor.

Projection lens Model No.	Standard zoom lens/ET-ELS20/ET-ELW20/ ET-ELT22/ET-ELT23	ET-ELW22
Lens shift range		

Note

- Use the projection lens in the standard projection position without adjusting the lens shift when the optional Fixed-focus Lens (Model No.: ET-ELW21) is attached.

Adjusting adjustable feet

Install the projector on a flat surface so that the front of the projector is parallel to the screen surface and the projection screen is rectangular.

If the screen is tilted downward, extend the front adjustable feet so that the projected image becomes rectangular. The adjustable feet can also be used to adjust the projector to be level when it is tilted in the horizontal direction.

Adjustable feet can be extended by turning them as shown in the figure. Turning them in the opposite direction will return them to the original position.

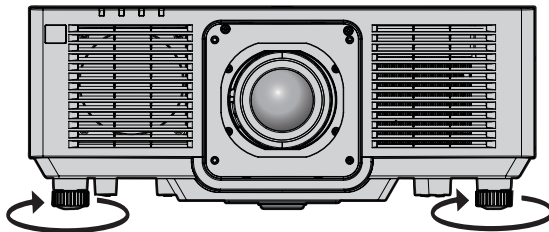

Maximum adjustable range
Adjustable feet: 23 mm (29/32") each

Attention

- Be careful not to block the intake/exhaust vents with your hands or any objects when adjusting the adjustable feet while the light source is on. (➔ page 32)

Operating with the remote control

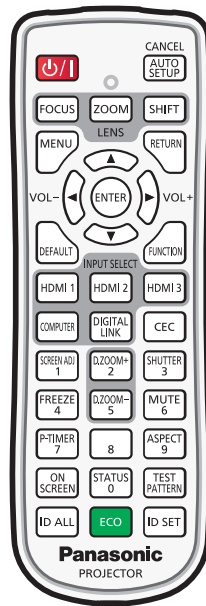

Using the shutter function

If the projector is not used for a certain period of time during the meeting intermission, for example, it is possible to turn off the image and audio temporarily.

button

- 1) **Press the <SHUTTER> button.**
 - The image and audio disappear.
 - This operation can be also performed by pressing the <SHUTTER> button on the control panel.
- 2) **Press the <SHUTTER> button again.**
 - The image and audio reappear.

Note

- The power indicator <ON (G)/STANDBY (R)> will blink green slowly while the shutter function is in use (shutter: closed).
- The fade-in/fade-out time of the image can be set in the [DISPLAY OPTION] menu → [SHUTTER SETTING] (▶ page 107).
- To output audio while the shutter function is in use (shutter: closed), set the [PROJECTOR SETUP] menu → [AUDIO SETTING] (▶ page 121) → [IN SHUTTER] to [ON].
- The light source may be lit dimly due to warm up when the shutter function is used in the operating environment temperature of around 0 °C (32 °F).

Using the mute function

Audio can be temporarily turned off.

button

- 1) **Press the <MUTE> button.**
 - The audio is muted.
- 2) **Press the <MUTE> button again.**
 - The audio is turned on.

Adjusting the volume

Adjust the volume of audio output.



- 1) Press the <VOL-> button/<VOL+> button on the remote control.

<VOL+>	Increases the volume.
<VOL->	Decreases the volume.

Note

- This operation can be also performed using ◀▶ on the control panel.

Using the freeze function

The projected image can be paused and audio can be turned off regardless of the playback of the external device.



- 1) Press the <FREEZE> button.
 - The image freezes and audio is muted.
- 2) Press the <FREEZE> button again.
 - Freezing of the image is canceled and audio is turned on.

Note

- [FREEZE] is displayed on the screen when video is paused.
- When freezing of the moving image is canceled, the image may disappear or be disrupted temporarily.

Using the on-screen display function

Turn off the on-screen display function (no display) when you do not wish the viewers to see the on-screen display, such as the menu or the input terminal name.



- 1) Press the <ON SCREEN> button.
 - The on-screen display disappears.
- 2) Press the <ON SCREEN> button again.
 - The on-screen display appears.

Note

- If you press the <MENU> button on the control panel for at least three seconds while the on-screen display is off (hidden), the on-screen display is turned on.

Using the automatic setup function

The image position when the HDMI signal is input, or the dot clock, clock phase, and image position when the analog RGB signal is input can be adjusted automatically. (Analog RGB signal is a signal structured with dots just like the computer signal.)

It is recommended to input an image with bright white borders at the edges and high-contrast black and white characters when the automatic adjustment is being performed.

Avoid using images that include halftones or gradation, such as photographs and computer graphics.

CANCEL

 **button**

1) Press the <AUTO SETUP/CANCEL> button.

- [PROGRESS] is displayed while automatic setup is being executed.
- [COMPLETE] is displayed when automatic setup has completed without any problem.

Note

- The clock phase may shift even if it has completed without any incident. In such a case, adjust the [POSITION] menu → [CLOCK PHASE] (➡ page 87).
- The automatic setup may not correctly adjust when a image that cannot determine the edge or dark image is input. In such a case, adjust the following settings.
 - [ADVANCED MENU] menu → [INPUT RESOLUTION] (➡ page 92)
 - [POSITION] menu → [CLOCK PHASE] (➡ page 87)
 - [POSITION] menu → [SHIFT] (➡ page 85)
- Adjust special signals according to the [DISPLAY OPTION] menu → [AUTO SETUP] (➡ page 97).
- Automatic adjustment may not be possible depending on the computer model.
- Automatic adjustment may not be possible for the synchronization signal for composite sync or SYNC ON GREEN.
- Image may be disrupted for a few seconds during automatic adjustment, but this is not a malfunction.
- Adjustment is required for each input signal.
- Automatic adjustment can be canceled by pressing the <MENU> button or the <RETURN> button during the automatic adjustment operation.
- Even if a signal possible to perform the automatic setup is being input, it may not be able to adjust correctly if the automatic setup function is used while the moving image is being input.
- If the [DISPLAY OPTION] menu → [SIGNAL SEARCH] is set to [ON], the signal search function is activated when the <AUTO SETUP/CANCEL> button is pressed while no signal is input.
For details of the signal search function, refer to the [DISPLAY OPTION] menu → [SIGNAL SEARCH] (➡ page 104).

Using the screen adjustment function

The [SCREEN ADJUSTMENT] menu can be displayed.

Correct the distortion of the image that occurs when the projector is installed tilted or when the screen is tilted or curved.

 **button**

1) Press the <SCREEN ADJ> button.

- The [SCREEN ADJUSTMENT] screen is displayed.

2) Press ◀▶ to switch the item.

- The items will switch each time you press the button.

[OFF]	Does not perform [SCREEN ADJUSTMENT].
[KEYSTONE]	Adjusts any trapezoidal distortion in the projected image.
[CORNER CORRECTION]	Adjusts any distortion in the four corners of the projected image.
[CURVED CORRECTION]	Adjusts any curved distortion in the projected image.
[PC-1]	Select this item when performing correction using a computer and “Geometric & Setup Management Software” ^{*1} . Up to three correction data can be saved.
[PC-2]	
[PC-3]	

*1 “Geometric & Setup Management Software” can be downloaded from the website (<https://panasonic.net/cns/projector/pass/>). It is necessary to register and login to PASS to download.

- The items will also switch by pressing the <SCREEN ADJ> button.
- Proceed to Step 3) when [KEYSTONE], [CORNER CORRECTION] or [CURVED CORRECTION] is selected.

3) Press the <ENTER> button.

- The [KEYSTONE] screen, the [CORNER CORRECTION] screen, or the [CURVED CORRECTION] screen is displayed.

Note

- To adjust [KEYSTONE] or [CURVED CORRECTION], press ▲▼ to select the item to adjust, and press ◀▶ to adjust the item.
- To adjust [CORNER CORRECTION], press ▲▼ to select the item to adjust. Individual adjustment screen is displayed by pressing the <ENTER> button. Adjust the item using ▲▼◀▶.
- Only one of the [KEYSTONE], [CORNER CORRECTION], or [CURVED CORRECTION] setting is enabled.
- Refer to the [POSITION] menu → [SCREEN ADJUSTMENT] (➡ page 88) for details.

Using the digital zoom function

(When RGB signal for still images, HDMI signal for still images, or DIGITAL LINK signal for still images is input.)
Enlarge the image or move the enlargement area of the image.

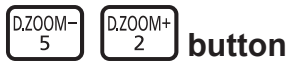

1) Press the <D.ZOOM-> button/<D.ZOOM+> button.

- When executed from the remote control operation, the [DIGITAL ZOOM] individual adjustment screen is not displayed, and the move screen is displayed.
- When executed from the menu operation, the [DIGITAL ZOOM] individual adjustment screen is displayed. For details, refer to the [DISPLAY OPTION] menu → [DIGITAL ZOOM] (➡ page 109).

2) Move the enlargement position or adjust the magnification with following button operation.

- The digital zoom is canceled when the <AUTO SETUP/CANCEL> button on the remote control or the <LENS/CANCEL> button on the control panel is pressed while performing the digital zoom.

Operation menu/button	Operation	Adjustment
<p>Move screen</p> <p>Remote control operation button</p>	Press ▲.	The image moves down.
	Press ▼.	The image moves up.
	Press ◀.	The image moves right.
	Press ▶.	The image moves left.
	Press the <MENU> button.	Displays the top left corner.
	Press the <RETURN> button.	Displays the top right corner.
	Press the <ENTER> button.	Displays the center.
	Press the <DEFAULT> button.	Displays the bottom left corner.
	Press the <FUNCTION> button.	Displays the bottom right corner.
	Press the <D.ZOOM+> button.	Increases the magnification.
Press the <D.ZOOM-> button.	Decreases the magnification.	

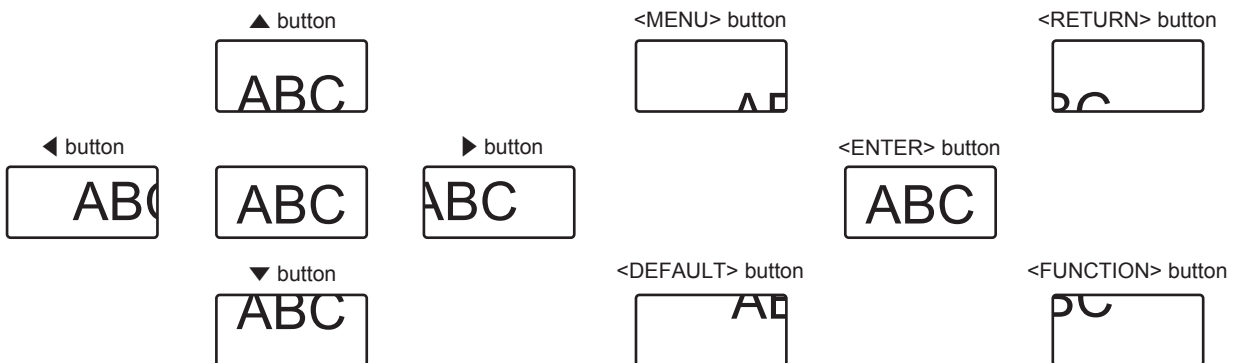

The screen display position after the button operation

Note

- The magnification is not displayed in the move screen.
- The adjustment value of the digital zoom is canceled when the type of input signal is changed while performing the digital zoom.
- The freeze function is disabled while performing the digital zoom.
- The digital zoom will not operate in some of the still image signals.

Switching the image aspect ratio

Switch the image aspect ratio according to the input.



1) Press the <ASPECT> button.

- The setting will change each time you press the button.

Note

- Refer to the [POSITION] menu → [ASPECT] (➡ page 85) for details.

Using the presentation timer function

The presentation timer can be operated.

The presentation can be performed while confirming the elapsed time or remaining time against the specified time.



1) Press the <P-TIMER> button.

- Starts the count.

2) Press the <P-TIMER> button again.

- Stops the count.

Note

- The elapsed time or remaining time is displayed at the bottom right of the projected image while using the presentation timer.
- The count will restart when the <P-TIMER> button is pressed while the count is stopped.
- The presentation timer is ended when the <P-TIMER> button is pressed and held for 3 seconds or longer.
- For details such as setting of the presentation timer function, refer to the [DISPLAY OPTION] menu → [P-TIMER] (➡ page 108).

Using the function button

By assigning the following functions to the <FUNCTION> button, it can be used as a simplified shortcut button. [SUB MEMORY], [SYSTEM SELECTOR], [DAYLIGHT VIEW]



1) Press the <FUNCTION> button.

Note

- Assignment of the function is performed from the [PROJECTOR SETUP] menu → [FUNCTION BUTTON] (➡ page 120).

Displaying internal test pattern

To confirm the status of the projector, ten types of internal test patterns can be displayed. To display test patterns, perform the following steps.



1) Press the <TEST PATTERN> button.

2) Press ◀▶ to select the test pattern.

Note

- Test patterns can also be displayed using the menu operation. Refer to "[TEST PATTERN] menu" (➡ page 129) for details.
- Settings of position, size, and other factors will not be reflected in test patterns. Make sure to display the input signal before performing various adjustments.

Using the status function

Display the status of the projector.



button

1) Press the <STATUS> button.

- The [STATUS] screen is displayed.

STATUS		1/3
PROJECTOR TYPE	PT-MZ880	
SERIAL NUMBER	SW1234567	
PROJECTOR RUNTIME	10h	
LIGHT RUNTIME	10h	
CONTINUOUS LIGHTING TIME	1h 23m	
MAIN/SUB VERSION	1.00 / 1.00	
INTAKE AIR TEMP.	31°C/87°F	
EXHAUST AIR TEMP.	31°C/87°F	
LIGHT TEMP. 1	31°C/87°F	
LIGHT TEMP. 2	31°C/87°F	
SELF TEST	NO ERRORS	
<small>ENTER</small> SEND E-MAIL		
<small>←</small> CHANGE <small>ENTER</small> EXIT		

Note

- The projector status can also be displayed using the menu operation. Refer to the [PROJECTOR SETUP] menu → [STATUS] (➔ page 124) for details.

Using the ECO management function

Display the setting screen relating to ECO management.



button

1) Press the <ECO> button.

Note

- Refer to the [PROJECTOR SETUP] menu → [ECO MANAGEMENT] (➔ page 111) for details.

Using the HDMI-CEC function

Display the HDMI-CEC operation screen.



button

1) Press the <CEC> button.

- The HDMI-CEC operation screen is displayed.

Note

- Refer to [PROJECTOR SETUP] menu → [HDMI CEC] (➔ page 126) for details.
- Pressing the <CEC> button during digital zoom will cancel the digital zoom adjustment.

Setting ID number of the remote control

When you use the multiple projectors together, you can operate all the projectors simultaneously or each projector individually using a single remote control, if a unique ID number is assigned to each projector.

After setting the ID number of the projector, set same ID number on the remote control.

The factory default ID number of the projector is set to [ALL]. When using a single projector, press the <ID ALL> button on the remote control. Also, you can control a projector by pressing the <ID ALL> button on the remote control even if you do not know the projector ID.



- 1) Press the <ID SET> button on the remote control.
- 2) Within five seconds, press and set the one-digit or two-digit ID number set on the projector body using the number (<0> - <9>) buttons.
 - If you press the <ID ALL> button, you can control the projectors regardless of the ID number setting of the projector body.

Attention

- Since the ID number of the remote control can be set without the projector body, do not press the <ID SET> button on the remote control carelessly. If the <ID SET> button is pressed and no number (<0> - <9>) buttons are pressed within five seconds, the ID number returns to its original value before the <ID SET> button was pressed.
- The ID number set on the remote control will be stored unless it is set again. However, it will be erased if the remote control is left with dead batteries. Set the same ID number again when the batteries are replaced.

Note

- When the ID number of the remote control is set to [0], the projectors can be controlled regardless of the ID number setting on the projector, same as when set to [ALL].
- Set the ID number of the projector from the [PROJECTOR SETUP] menu → [PROJECTOR ID] (➔ page 110).

Chapter 4 Settings

This chapter describes the settings and adjustments you can make using the on-screen menu.

Menu navigation

The on-screen menu (Menu) is used to perform various settings and adjustments of the projector.

Navigating through the menu

Operating procedure



button

- 1) Press the <MENU> button on the remote control or control panel.
 - The [MAIN MENU] screen is displayed.

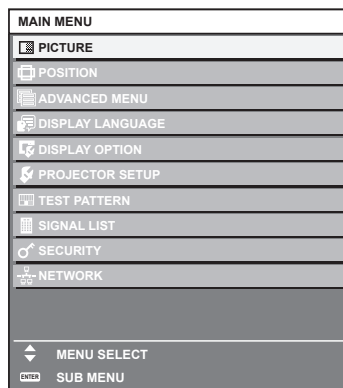

- 2) Press ▲▼ to select an item from the main menu.
 - The selected item is highlighted in yellow.

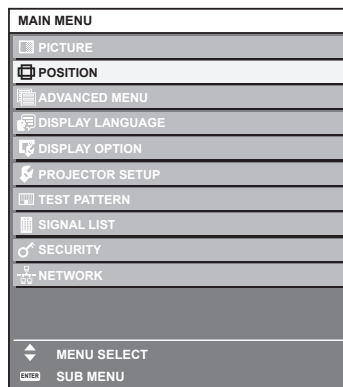

- 3) Press the <ENTER> button.
 - The sub-menu items of the selected main menu are displayed.

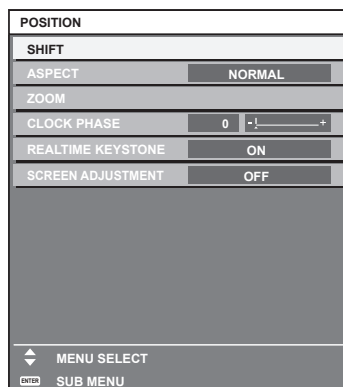

4) Press ▲▼ to select a sub-menu, and press ◀▶ or the <ENTER> button to change or adjust settings.

- Some items will switch in order as follows each time you press ◀▶.

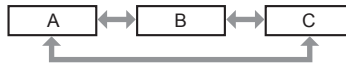

- For some items, press ◀▶ to display an individual adjustment screen with a bar scale as shown below.



Note

- Pressing the <MENU> button while the menu screen is displayed returns to the previous menu. Same operation is available by pressing the <RETURN> button.
- Some items cannot be adjusted or some functions cannot be used depending on the signal that is input to the projector. The item in the menu screen is displayed in black text when it cannot be adjusted or selected. If the item in the menu screen is displayed in black characters and the item cannot be adjusted or set, the factor causing it is displayed by pressing the <ENTER> button while the corresponding menu is selected.
- Some items can be adjusted even if signals are not input.
- Individual adjustment screen is cleared automatically if no operation is performed for approximately five seconds.
- For menu items, refer to “Main menu” (➔ page 76) and “Sub-menu” (➔ page 76).
- The cursor color depends on the setting in the [DISPLAY OPTION] menu → [ON-SCREEN DISPLAY] → [OSD COLOR]. The selected item is displayed with the yellow cursor by the factory default.
- In the portrait setting, the on-screen menu is displayed sideways. To display the on-screen menu vertically, change the setting of the [DISPLAY OPTION] menu → [ON-SCREEN DISPLAY] → [OSD ROTATION].

Resetting adjustment values to the factory default

If the <DEFAULT> button on the remote control is pressed, the values adjusted in the menu items are restored to the factory default settings.



1) Press the <DEFAULT> button on the remote control.



Note



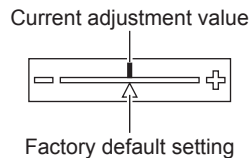







- You cannot reset all the settings to the factory default at a time.
- To reset all the settings adjusted in the sub-menu item to the factory default one at a time, execute the [PROJECTOR SETUP] menu → [INITIALIZE].
- Some items cannot be reset to the factory default settings even when the <DEFAULT> button on the remote control is pressed. Adjust those items individually.
- The triangular mark under the bar scale in the individual adjustment screen indicates the factory default setting. The position of the triangular mark varies according to the selected input signals.



Main menu

The following items are in the main menu.

When a main menu item is selected, the screen changes to a sub-menu selection screen.

Main menu item		Page
	[PICTURE]	79
	[POSITION]	85
	[ADVANCED MENU]	91
	[DISPLAY LANGUAGE]	95
	[DISPLAY OPTION]	96
	[PROJECTOR SETUP]	110
	[TEST PATTERN]	129
	[SIGNAL LIST]	130
	[SECURITY]	133
	[NETWORK]	137

Sub-menu

The sub-menu of the selected main menu item is displayed, and you can set and adjust items in the sub-menu.

[PICTURE]

Sub-menu item	Factory default	Page
[PICTURE MODE]	[STANDARD] ^{*1}	79
[CONTRAST]	[0]	79
[BRIGHTNESS]	[0]	79
[COLOR]	[0]	80
[TINT]	[0]	80
[COLOR TEMPERATURE]	[DEFAULT] ^{*2}	80
[GAMMA]	[0]	81
[DAYLIGHT VIEW]	[AUTO] ^{*2}	82
[SHARPNESS]	[+6] ^{*2}	82
[NOISE REDUCTION]	[OFF] ^{*2}	82
[DYNAMIC CONTRAST]	[OFF] ^{*2}	83
[SYSTEM SELECTOR]	[AUTO] ^{*1}	83

*1 Depends on the signal input.

*2 Depends on the [PICTURE MODE].

[POSITION]

Sub-menu item	Factory default	Page
[SHIFT]	—	85
[ASPECT]	[NORMAL]	85
[ZOOM]	—	86
[CLOCK PHASE]	[0] ^{*1}	87
[REALTIME KEYSTONE]	[OFF]	87
[SCREEN ADJUSTMENT]	[OFF]	88

*1 Depends on the signal input.

[ADVANCED MENU] 

Sub-menu item	Factory default	Page
[DIGITAL CINEMA REALITY]	[AUTO] ^{*1}	91
[BLANKING]	—	91
[INPUT RESOLUTION]	—	92
[EDGE BLENDING]	[OFF]	92
[CLAMP POSITION]	[24] ^{*1}	94
[RASTER POSITION]	—	94

*1 Depends on the signal input.

Note

- The factory default setting varies depending on the selected input terminal.

[DISPLAY LANGUAGE] 

Details (➔ page 95)

[DISPLAY OPTION] 

Sub-menu item	Factory default	Page
[COLOR ADJUSTMENT]	[OFF]	96
[COLOR CORRECTION]	[OFF]	96
[SCREEN SETTING]	—	97
[AUTO SIGNAL]	[OFF]	97
[AUTO SETUP]	—	97
[COMPUTER IN]	—	98
[HDMI IN]	—	99
[DIGITAL LINK IN]	—	101
[ON-SCREEN DISPLAY]	—	102
[SIGNAL SEARCH]	[ON]	104
[BACK COLOR]	[BLUE]	105
[STARTUP LOGO]	[DEFAULT LOGO]	105
[UNIFORMITY]	—	105
[SHUTTER SETTING]	—	107
[P-TIMER]	—	108
[FREEZE]	—	109
[DIGITAL ZOOM]	—	109

[PROJECTOR SETUP] 

Sub-menu item	Factory default	Page
[PROJECTOR ID]	[ALL]	110
[PROJECTION METHOD]	—	110
[ECO MANAGEMENT]	—	111
[INITIAL STARTUP]	[LAST MEMORY]	113
[STARTUP INPUT SELECT]	[LAST USED]	113
[DATE AND TIME]	—	114
[SCHEDULE]	[OFF]	115
[MULTI PROJECTOR SYNC]	—	116
[RS-232C]	—	118
[REMOTE2 MODE]	[DEFAULT]	120
[FUNCTION BUTTON]	—	120
[LENS]	—	120
[AUDIO SETTING]	—	121

Sub-menu item	Factory default	Page
[FILTER COUNTER]	—	123
[DC OUT]	[ON]	124
[STATUS]	—	124
[DATA CLONING]	—	125
[SAVE ALL USER DATA]	—	125
[LOAD ALL USER DATA]	—	125
[HDMI CEC]	[ON]	126
[INITIALIZE]	—	128
[SERVICE PASSWORD]	—	128

[TEST PATTERN]

Details (➔ page 129)

[SIGNAL LIST]

Details (➔ page 130)

[SECURITY]

Sub-menu item	Factory default	Page
[SECURITY PASSWORD]	[OFF]	133
[SECURITY PASSWORD CHANGE]	—	133
[DISPLAY SETTING]	[OFF]	133
[TEXT CHANGE]	—	134
[MENU LOCK]	[OFF]	134
[MENU LOCK PASSWORD]	—	134
[CONTROL DEVICE SETUP]	—	135
[CONTROL DEVICE PASSWORD CHANGE]	—	136

[NETWORK]

Sub-menu item	Factory default	Page
[ETHERNET TYPE]	[LAN]	137
[DIGITAL LINK]	—	137
[WIRED LAN]	—	139
[PROJECTOR NAME]	—	139
[NETWORK STATUS]	—	140
[ADMINISTRATOR ACCOUNT]	—	140
[NETWORK SECURITY]	—	142
[NETWORK CONTROL]	—	143
[PJLink]	—	143
[Art-Net]	—	145

Note

- Some items may not be adjusted or used for certain signal formats to be input to the projector.
The item in the menu screen is displayed in black text when it cannot be adjusted or selected.
- Display of the sub-menu item and the value of factory default setting vary depending on the selected input.

[PICTURE] menu

On the menu screen, select [PICTURE] from the main menu, and select an item from the sub-menu. Refer to “Navigating through the menu” (➔ page 74) for the operation of the menu screen.

[PICTURE MODE]

You can switch to the desired picture mode suitable for the image source and the environment in which the projector is used.

- 1) Press ▲▼ to select [PICTURE MODE].
- 2) Press ◀▶ or the <ENTER> button.
 - The [PICTURE MODE] individual adjustment screen is displayed.
- 3) Press ◀▶ to switch the item.
 - The items will switch each time you press the button.

[STANDARD]	The image becomes suitable for moving images in general.
[DYNAMIC]	The image becomes suitable for use in bright areas.
[DICOM SIM.]	The image becomes similar to that of DICOM Part 14 Grayscale Standard.
[WHITE BOARD]	The image becomes appropriate to project on a whiteboard.
[CINEMA]	The image becomes suitable for movie contents.
[NATURAL]	The image becomes appropriate to use in a dark room.

Note

- DICOM is an abbreviation of “Digital Imaging and COmmunication in Medicine” and is a standard for medical imaging devices. Although the DICOM name is used, the projector is not a medical device, and display images should not be used for medical purposes such as diagnosis.

[CONTRAST]

You can adjust the contrast of the colors.

- 1) Press ▲▼ to select [CONTRAST].
- 2) Press ◀▶ or the <ENTER> button.
 - The [CONTRAST] individual adjustment screen is displayed.
- 3) Press ◀▶ to adjust the level.

Operation	Adjustment	Range of adjustment
Press ▶.	The screen becomes brighter.	-31 - +31
Press ◀.	The screen becomes darker.	

Attention

- When it is necessary to adjust [CONTRAST] and [BRIGHTNESS], adjust the [PICTURE] menu → [BRIGHTNESS] first.

[BRIGHTNESS]

You can adjust the dark (black) part of the projected image.

- 1) Press ▲▼ to select [BRIGHTNESS].
- 2) Press ◀▶ or the <ENTER> button.
 - The [BRIGHTNESS] individual adjustment screen is displayed.
- 3) Press ◀▶ to adjust the level.

Operation	Adjustment	Range of adjustment
Press ▶.	Increases the brightness of the dark (black) parts of the screen.	-31 - +31
Press ◀.	Reduces the brightness of the dark (black) parts of the screen.	

[COLOR]

You can adjust the color saturation of the projected image.

- 1) Press ▲▼ to select [COLOR].
- 2) Press ◀▶ or the <ENTER> button.
 - The [COLOR] individual adjustment screen is displayed.
- 3) Press ◀▶ to adjust the level.

Operation	Adjustment	Range of adjustment
Press ▶.	Deepens colors.	-31 - +31
Press ◀.	Weakens colors.	

[TINT]

You can adjust the skin tone in the projected image.

- 1) Press ▲▼ to select [TINT].
- 2) Press ◀▶ or the <ENTER> button.
 - The [TINT] individual adjustment screen is displayed.
- 3) Press ◀▶ to adjust the level.

Operation	Adjustment	Range of adjustment
Press ▶.	Adjusts skin tone toward greenish color.	-31 - +31
Press ◀.	Adjusts skin tone toward reddish purple.	

[COLOR TEMPERATURE]

You can switch the color temperature if the white areas of the projected image are bluish or reddish.

Adjusting with color temperature

- 1) Press ▲▼ to select [COLOR TEMPERATURE].
- 2) Press ◀▶ or the <ENTER> button.
 - The [COLOR TEMPERATURE] individual adjustment screen is displayed.
- 3) Press ◀▶ to switch the item.
 - The items will switch each time you press the button.

[DEFAULT]	Factory default setting.
[USER]	Adjusts white balance as desired. Refer to "Adjusting desired white balance" (➔ page 80) for details.
[LOW]/[HIGH]	Select an item so that images become natural.

Note

- [DEFAULT] cannot be selected when the [PICTURE] menu → [PICTURE MODE] is set to [DICOM SIM].
- This item is fixed to [USER] when the [DISPLAY OPTION] menu → [COLOR ADJUSTMENT] is set to anything other than [OFF].

Adjusting desired white balance

- 1) Press ▲▼ to select [COLOR TEMPERATURE].
- 2) Press ◀▶ or the <ENTER> button.
 - The [COLOR TEMPERATURE] individual adjustment screen is displayed.
- 3) Press ◀▶ to select [USER].
- 4) Press the <ENTER> button.
 - The [COLOR TEMPERATURE] screen is displayed.

- 5) Press ▲▼ to select [WHITE BALANCE].
- 6) Press the <ENTER> button.
 - The [WHITE BALANCE] screen is displayed.
- 7) Press ▲▼ to select [WHITE BALANCE HIGH] or [WHITE BALANCE LOW].
- 8) Press the <ENTER> button.
 - The [WHITE BALANCE HIGH] screen or the [WHITE BALANCE LOW] screen is displayed.
- 9) Press ▲▼ to select [RED], [GREEN], or [BLUE].
- 10) Press ◀▶ to adjust the level.

Item	Operation	Adjustment	Range of adjustment
[RED]	Press ▶.	Deepens red.	[WHITE BALANCE HIGH]: 0 - +255 (factory default is +255) [WHITE BALANCE LOW]: -127 - +127 (factory default is 0)
	Press ◀.	Weakens red.	
[GREEN]	Press ▶.	Deepens green.	
	Press ◀.	Weakens green.	
[BLUE]	Press ▶.	Deepens blue.	
	Press ◀.	Weakens blue.	

Note

- Adjust [COLOR TEMPERATURE] correctly. All colors will not be displayed properly unless adequate adjustment is made. If the adjustment does not look suitable, you can press the <DEFAULT> button on the remote control to return the setting for the selected item only to the factory default setting.

Changing the [USER] name

- 1) Press ▲▼ to select [COLOR TEMPERATURE].
- 2) Press ◀▶ or the <ENTER> button.
 - The [COLOR TEMPERATURE] individual adjustment screen is displayed.
- 3) Press ◀▶ to select [USER].
- 4) Press the <ENTER> button.
 - The [COLOR TEMPERATURE] screen is displayed.
- 5) Press ▲▼ to select [COLOR TEMPERATURE NAME CHANGE].
- 6) Press the <ENTER> button.
 - The [COLOR TEMPERATURE NAME CHANGE] screen is displayed.
- 7) Press ▲▼◀▶ to select the text, and press the <ENTER> button to enter the text.
- 8) Press ▲▼◀▶ to select [OK], and press the <ENTER> button.
 - The name set to color temperature is changed.

Note

- When a name is changed, display of [USER] is also changed.

[GAMMA]

You can switch gamma mode.

- 1) Press ▲▼ to select [GAMMA].
- 2) Press ◀▶ or the <ENTER> button.
 - The [GAMMA] individual adjustment screen is displayed.
- 3) Press ◀▶ to adjust the level.

Operation	Adjustment	Range of adjustment
Press ►.	The intermediate tone becomes brighter.	-8 - +7
Press ◀.	The intermediate tone becomes darker.	

[DAYLIGHT VIEW]

You can correct the image to the optimal vividness even if it is projected under a bright light.

- 1) Press ▲▼ to select [DAYLIGHT VIEW].
- 2) Press ◀▶ or the <ENTER> button.
 - The [DAYLIGHT VIEW] individual adjustment screen is displayed.
- 3) Press ◀▶ to switch the item.
 - The items will switch each time you press the button.

[AUTO]	Detects the brightness of the installed environment by the luminance sensor, and automatically corrects the vividness of the image.
[OFF]	No correction.
[1]	Corrects the image to weaken vividness.
[2]	Corrects the image to medium vividness.
[3]	Corrects the image to high vividness.

Note

- [AUTO] cannot be selected when the [PROJECTOR SETUP] menu → [FRONT/REAR] of [PROJECTION METHOD] is set to [REAR].
- The luminance may not be detected correctly when an object is placed on top of the projector, blocking the luminance sensor. In such a case, this function may not operate properly even if it is set to [AUTO].
- When the [PICTURE] menu → [PICTURE MODE] is set to [DICOM SIM.], the factory default value is [OFF].

[SHARPNESS]

You can adjust the sharpness of the projected image.

- 1) Press ▲▼ to select [SHARPNESS].
- 2) Press ◀▶ or the <ENTER> button.
 - The [SHARPNESS] individual adjustment screen is displayed.
- 3) Press ◀▶ to adjust the level.

Operation	Adjustment	Range of adjustment
Press ►.	Contours become sharper.	0 - +15
Press ◀.	Contours become softer.	

[NOISE REDUCTION]

You can reduce noises when the input image is degraded and noise is occurring in the image signal.

- 1) Press ▲▼ to select [NOISE REDUCTION].
- 2) Press ◀▶ or the <ENTER> button.
 - The [NOISE REDUCTION] individual adjustment screen is displayed.
- 3) Press ◀▶ to switch the item.
 - The items will switch each time you press the button.

[OFF]	No correction.
[1]	Slightly corrects the noise.
[2]	Moderately corrects the noise.
[3]	Strongly corrects the noise.

Attention

- When this is set for an input signal with less noise, the image may look different from the original image. In such a case, set it to [OFF].

[DYNAMIC CONTRAST]

Light adjustment of the light source and signal compensation are performed automatically according to the image to make the contrast optimum for the image.

- 1) Press ▲▼ to select [DYNAMIC CONTRAST].
- 2) Press ◀▶ or the <ENTER> button.
 - The [DYNAMIC CONTRAST] individual adjustment screen is displayed.
- 3) Press ◀▶ to switch the item.
 - The items will switch each time you press the button.

[OFF]	Disables the dynamic contrast function.
[1]	Adjusts the light source and compensates signals to a small extent.
[2]	Adjusts the light source and compensates signals to a large extent.
[USER]	The light source can be set to turn off when the brightness level of the input video signal falls below a certain value. Refer to "Setting the light off condition of the light source" (➔ page 83) for details.

Setting the light off condition of the light source

- 1) Press ▲▼ to select [DYNAMIC CONTRAST].
- 2) Press ◀▶ or the <ENTER> button.
 - The [DYNAMIC CONTRAST] individual adjustment screen is displayed.
- 3) Press ◀▶ to select [USER].
- 4) Press the <ENTER> button.
 - The [DYNAMIC CONTRAST] screen is displayed.
- 5) Press ▲▼ to select the item to set.
 - The items in the detailed setting will switch each time you press ◀▶.

Setting item	Details	
[LIGHTS OUT TIMER] (Setting of the waiting time before turning off the light)	[DISABLE]	Does not turn off the light source.
	[0.5s] ~ [10.0s]	Turns off the light source when the brightness level of the video signal being input goes under the value set in [LIGHTS OUT SIGNAL LEVEL]. Select an item from [0.5s] - [4.0s], [5.0s], [7.0s], or [10.0s]. [0.5s] - [4.0s] can be selected in increments of 0.5.
[LIGHTS OUT SIGNAL LEVEL] (Setting of the brightness level of the signal to turn off the light)	[0%] ~ [5%] Sets the level of the brightness of the video signal to turn off the light source with [LIGHTS OUT TIMER]. Can be set in increments of 1%. (Factory setting: 0%)	

Note

- [LIGHTS OUT SIGNAL LEVEL] cannot be set when [LIGHTS OUT TIMER] is set to [DISABLE].
- When [LIGHTS OUT TIMER] is set to anything other than [DISABLE], the following are the conditions to turn the light source back on again from the state that the light source has turned off by this function.
 - When the brightness level of the video signal being input has exceeded the value set in [LIGHTS OUT SIGNAL LEVEL]
 - When the input signal is gone
 - When on-screen display such as menu screen (OSD) or input guide, a test pattern, or a warning message is displayed
- When the image of analog signal is projected, the image may be affected by the signal noise while the brightness level of the video signal is detected. In such case, it is determined that the signal has not fallen below even when the brightness level of the image falls below the value set in [LIGHTS OUT SIGNAL LEVEL].

[SYSTEM SELECTOR]

The projector will automatically detect the input signal, but you can set the system method manually when an unstable signal is input. Set the system method matching the input signal.

- 1) Press ▲▼ to select [SYSTEM SELECTOR].
- 2) Press the <ENTER> button.

3) Press ▲▼ to select a system format.

- Available system formats vary depending on the input signal.

Terminal	System format	
<COMPUTER IN> terminal	576/50p signal	Select [RGB] or [YCbCr].
	640 x 480/60 or 480/60p signal	Select [640x480/60], [480/60p YCbCr], or [480/60p RGB].
	Other moving image signals	Select [RGB] or [YPbPr].
<HDMI IN 1> terminal, <HDMI IN 2> terminal, <HDMI IN 3> terminal, <DIGITAL LINK/LAN> terminal	480/60p or 576/50p signal	Select [AUTO], [RGB], or [YCbCr].
	Other moving image signals	Select [AUTO], [RGB], or [YPbPr].

4) Press the <ENTER> button.

Note

- For details of the types of video signals that can be used with the projector, refer to “List of compatible signals” (► page 205).
- This may not function properly for some connected external devices.

[POSITION] menu

On the menu screen, select [POSITION] from the main menu, and select an item from the sub-menu. Refer to “Navigating through the menu” (➔ page 74) for the operation of the menu screen.

Note

- When the optional DIGITAL LINK output supported device (Model No.: ET-YFB100G, ET-YFB200G) is connected to the <DIGITAL LINK/ LAN> terminal, adjust the shift, aspect, and clock phase from the menu of DIGITAL LINK output supported device at first.

[SHIFT]

Move the image position vertically or horizontally if the image projected on the screen is still out of position even when the positions of the projector and screen are correct.

- Press ▲▼ to select [SHIFT].
- Press the <ENTER> button.
 - The [SHIFT] screen is displayed.
- Press ▲▼◀▶ to adjust the position.

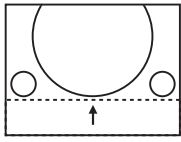
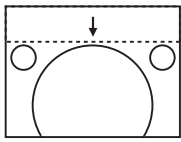
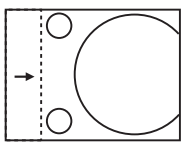
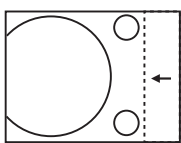
Orientation	Operation	Adjustment
Vertical (up and down) adjustment	Press ▲.	The image position moves up. 
	Press ▼.	The image position moves down. 
Horizontal (right and left) adjustment	Press ▶.	The image position moves to the right. 
	Press ◀.	The image position moves to the left. 

Note

- For the portrait setting, image position is moved horizontally when “Vertical (up and down) adjustment” is made. Image position is moved vertically when “Horizontal (right and left) adjustment” is made.

[ASPECT]

You can switch the aspect ratio of the image.

The aspect ratio is switched within the screen range selected in the [DISPLAY OPTION] menu → [SCREEN SETTING] → [SCREEN FORMAT]. Set [SCREEN FORMAT] first. (➔ page 97)

- Press ▲▼ to select [ASPECT].
- Press ◀▶ or the <ENTER> button.
 - The [ASPECT] individual adjustment screen is displayed.
- Press ◀▶ to switch the item.
 - The items will switch each time you press the button.

[NORMAL]	Displays images without changing the aspect ratio of the input signals.
[NATIVE]	Displays images without changing the resolution of the input signals.
[WIDE]	Display images by converting the aspect ratio to 16:9 when the standard signal is input ^{*1} . When wide signal is input ^{*2} , the images are displayed with the input aspect ratio.
[4:3]	Displays images with the input aspect ratio when the standard signal is input ^{*1} . When the wide signal is input ^{*2} , the images are displayed with the input signal but reduced to fit into the 4:3 screen.
[H FIT]	Displays images using the entire width of the screen range selected in [SCREEN FORMAT]. When signals have the aspect ratio vertically longer than the screen aspect ratio selected in [SCREEN FORMAT], the images are displayed with the top and bottom parts cut off.
[V FIT]	Displays images using the entire height of the screen range selected in [SCREEN FORMAT]. When signals have the aspect ratio horizontally longer than the aspect ratio of the screen selected in [SCREEN FORMAT], the images are displayed with the right and left parts cut off.
[FULL]	Displays images in the entire screen range selected in [SCREEN FORMAT]. When the aspect ratio of the input signals differs from that of the screen range, the images are displayed with the aspect ratio converted to that of the screen selected in [SCREEN FORMAT].

*1 Standard signals are input signals with an aspect ratio of 4:3 or 5:4.

*2 Wide-screen signals are input signals with an aspect ratio of 16:10, 16:9, 15:9 or 15:10.

Note

- Some size modes are not available for certain types of input signals. [NATIVE] cannot be selected for a 4K video signal (resolution of 3 840 x 2 160 or 4 096 x 2 160).
- If an aspect ratio which is different from the aspect ratio for the input signals is selected, the images will appear differently from the originals. Be careful of this when selecting the aspect ratio.
- If using the projector in places such as cafes or hotels to display programs for a commercial purpose or for public presentation, note that adjusting the aspect ratio or using the zoom function to change the screen images may be an infringement of the rights of the original copyright owner for that program under copyright protection laws. Take care when using a function of the projector such as the aspect ratio adjustment and zoom function.
- If conventional (normal) 4:3 images which are not wide-screen images are displayed on a wide screen, the edges of the images may not be visible or they may become distorted. Such images should be viewed as with an aspect ratio of 4:3 in the original format intended by the creator of the images.

[ZOOM]

You can adjust the image size.

The adjustments in [ZOOM] will differ depending on the setting of the [POSITION] menu → [ASPECT].

When [ASPECT] is set to other than [NORMAL] and [NATIVE]

- 1) Press ▲▼ to select [ZOOM].
- 2) Press the <ENTER> button.
 - The [ZOOM] screen is displayed.
- 3) Press ▲▼ to select [INTERLOCKED].
- 4) Press ◀▶ to switch the item.

[OFF]	Sets the [VERTICAL] and [HORIZONTAL] zoom ratio.
[ON]	Uses [BOTH] to set zoom ratio. Image can be enlarged or reduced vertically and horizontally at the same magnification.

- 5) Press ▲▼ to select [VERTICAL] or [HORIZONTAL].
 - If [ON] is selected, select [BOTH].
- 6) Press ◀▶ to adjust.

Note

- When the [POSITION] menu → [ASPECT] is set to [NATIVE], [ZOOM] cannot be adjusted.

When [ASPECT] is set to [NORMAL]

- 1) Press ▲▼ to select [ZOOM].
- 2) Press the <ENTER> button.
 - The [ZOOM] screen is displayed.

3) Press ▲▼ to select [MODE].

4) Press ◀▶ to switch the item.

[INTERNAL]	Enlarges the size within the aspect range set with [SCREEN FORMAT].
[FULL]	Enlarges or reduces the size using the entire display area set with [SCREEN FORMAT].

5) Press ▲▼ to select [INTERLOCKED].

6) Press ◀▶ to switch the item.

[OFF]	Sets the [VERTICAL] and [HORIZONTAL] zoom ratio.
[ON]	Uses [BOTH] to set zoom ratio. Image can be enlarged or reduced vertically and horizontally at the same magnification.

7) Press ▲▼ to select [VERTICAL] or [HORIZONTAL].

- If [ON] is selected, select [BOTH].

8) Press ◀▶ to adjust.

Note

- When the [POSITION] menu → [ASPECT] is set to anything other than [NORMAL], [MODE] is not displayed.

[CLOCK PHASE]

You can adjust the image to achieve an optimal image when there is a flickering image or smeared outlines.

1) Press ▲▼ to select [CLOCK PHASE].

2) Press ◀▶ or the <ENTER> button.

- The [CLOCK PHASE] individual adjustment screen is displayed.

3) Press ◀▶ to adjust.

- Adjustment value will change between [0] and [+31]. Adjust the image so that the amount of interference is at a minimum.

Note

- Adjustment may not be possible depending on the signal.
- There may be no optimal value if the output from the input computer is unstable.
- There may be no optimal value when the total dot number is shifted.
- [CLOCK PHASE] can be adjusted only when the YC_BC_R/YP_BP_R signal or the analog RGB signal is input to the <COMPUTER IN> terminal.
- [CLOCK PHASE] cannot be adjusted when a digital signal is input.
- The adjustment value will change to [0] when ▶ is pressed while it was at [+31]. Also, the adjustment value will change to [+31] when ◀ is pressed while it was at [0].

[REALTIME KEYSTONE]

The keystone distortion that occurs when the projector is installed tilted is adjusted automatically.

1) Press ▲▼ to select [REALTIME KEYSTONE].

2) Press ◀▶ to select the item to adjust.

[OFF]	The real-time keystone distortion correction function is not executed automatically.
[ON]	The real-time keystone distortion correction function is executed automatically.

Note

- The keystone distortion may not be corrected fully depending on the installation condition. In such case, adjust it with the [POSITION] menu → [SCREEN ADJUSTMENT].
- [REALTIME KEYSTONE] cannot be set in following cases.
 - When the [PROJECTOR SETUP] menu → [PROJECTION METHOD] → [FLOOR/CEILING] is set to [CEILING]
 - When the [PROJECTOR SETUP] menu → [PROJECTION METHOD] → [FLOOR/CEILING] is set to [AUTO], and the actual installation status is ceiling mount
- When [REALTIME KEYSTONE] and [SCREEN ADJUSTMENT] are both set to [OFF] and [REALTIME KEYSTONE] is changed to [ON], [SCREEN ADJUSTMENT] is changed to [KEYSTONE].

[SCREEN ADJUSTMENT]

You can correct various types of distortion in a projected image.

Unique image processing technology enables projection of a square image on a special screen shape.



- 1) Press ▲▼ to select [SCREEN ADJUSTMENT].
- 2) Press ◀▶ to switch the item.
 - The items will switch each time you press the button.

[OFF]	Does not perform [SCREEN ADJUSTMENT].
[KEYSTONE]	Adjusts any trapezoidal distortion in the projected image.
[CORNER CORRECTION]	Adjusts any distortion in the four corners of the projected image.
[CURVED CORRECTION]	Adjusts any curved distortion in the projected image.
[PC-1]	Select this item when performing correction using a computer and "Geometric & Setup Management Software"*1. Up to three correction data can be saved.
[PC-2]	
[PC-3]	

*1 "Geometric & Setup Management Software" can be downloaded from the website (<https://panasonic.net/cns/projector/pass/>). It is necessary to register and login to PASS to download.

Setting [KEYSTONE] or [CURVED CORRECTION]

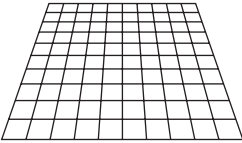
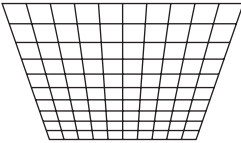
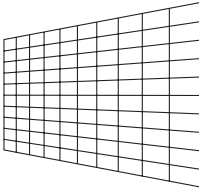
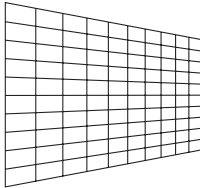
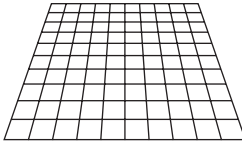
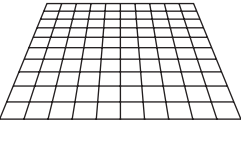
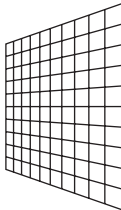
- 1) Press ▲▼ to select [SCREEN ADJUSTMENT].
- 2) Press ◀▶ to select [KEYSTONE] or [CURVED CORRECTION].
- 3) Press the <ENTER> button.
 - The [KEYSTONE] or [CURVED CORRECTION] screen is displayed.
- 4) Press ▲▼ to select the item to adjust.
- 5) Press ◀▶ to adjust.

[KEYSTONE]	
<p>[LENS THROW RATIO] Set the throw ratio. Select the value close to the actual projection distance divided by projected image width here. For details of the projection distance and the projected image width, refer to "Projected image and throw distance" (➡ page 38).</p>	
<p>[VERTICAL KEYSTONE]</p> <div style="display: flex; justify-content: space-around; align-items: center;">   </div>	<p>[HORIZONTAL KEYSTONE]</p> <div style="display: flex; justify-content: space-around; align-items: center;">   </div>
<p>[VERTICAL BALANCE]</p> <div style="display: flex; justify-content: space-around; align-items: center;">   </div> <p style="font-size: small;">Adjust the setting according to the lens shift range in the vertical direction.</p>	<p>[HORIZONTAL BALANCE]</p> <div style="display: flex; justify-content: space-around; align-items: center;">   </div> <p style="font-size: small;">Adjust the setting according to the lens shift range in the horizontal direction.</p>

[CURVED CORRECTION]
<p>[LENS THROW RATIO] Set the throw ratio. Select the value close to the actual projection distance divided by projected image width here. For details of the projection distance and the projected image width, refer to "Projected image and throw distance" (➡ page 38).</p>

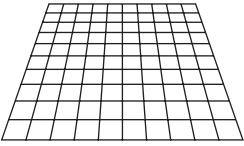
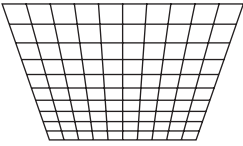
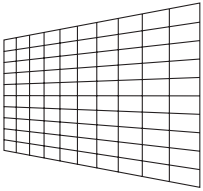
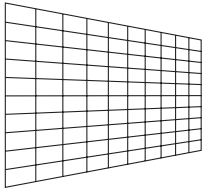
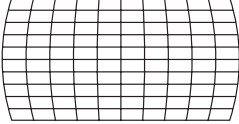
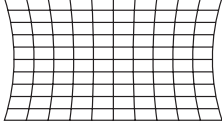
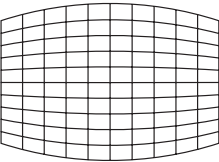
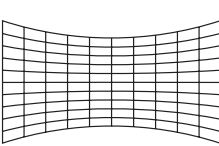
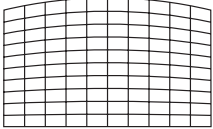
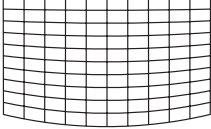
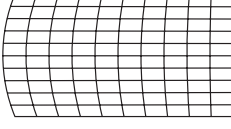
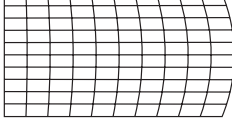
[CURVED CORRECTION]			
[VERTICAL KEYSTONE]		[HORIZONTAL KEYSTONE]	
			
[VERTICAL ARC]		[HORIZONTAL ARC]	
			
[VERTICAL BALANCE]		[HORIZONTAL BALANCE]	
			
[MAINTAIN ASPECT RATIO] Select [ON] to correct while keeping the aspect ratio.			

Setting [CORNER CORRECTION]

- 1) Press **▲▼** to select [SCREEN ADJUSTMENT].
- 2) Press **◀▶** to select [CORNER CORRECTION].
- 3) Press the **<ENTER>** button.
 - The [CORNER CORRECTION] screen is displayed.
- 4) Press **▲▼** to select the item to adjust, and press the **<ENTER>** button.
 - When [LINEARITY] is selected, press **◀▶** to select either adjustment method ([AUTO] or [MANUAL]). Select [AUTO] normally.
For details of operation when [MANUAL] is selected, refer to “Adjusting to desired linearity” (➡ page 90).
- 5) Press **▲▼◀▶** to adjust.

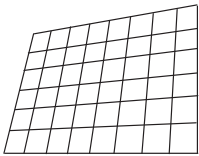
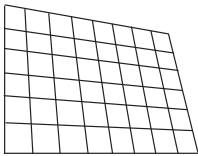
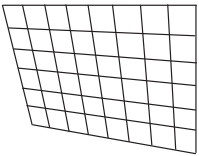
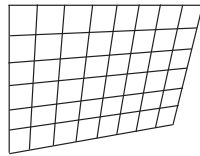
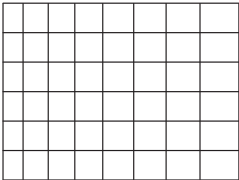
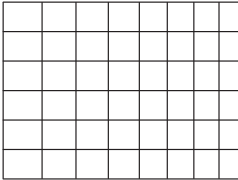
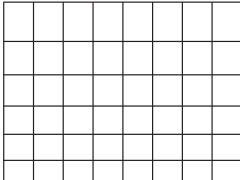
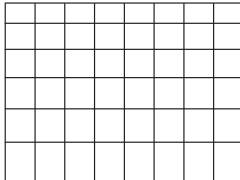
[CORNER CORRECTION]			
[UPPER LEFT]	[UPPER RIGHT]	[LOWER LEFT]	[LOWER RIGHT]
			
[LINEARITY]			
Horizontal direction		Vertical direction	
			

Adjusting to desired linearity

- 1) Press ▲▼ to select [SCREEN ADJUSTMENT].
- 2) Press ◀▶ to select [CORNER CORRECTION].
- 3) Press the <ENTER> button.
 - The [CORNER CORRECTION] screen is displayed.
- 4) Press ▲▼ to select [LINEARITY].
- 5) Press ◀▶ to select [MANUAL].
- 6) Press the <ENTER> button.
 - The [LINEARITY] screen is displayed.
- 7) Press ▲▼◀▶ to adjust.

Note

- Depending on the correction value, the aspect ratio of the image may change.
- The picture quality will degrade more when the correction for [SCREEN ADJUSTMENT] increases, making it harder to focus. Install the projector so that the correction will be as small as possible.
- Image size will also change when [SCREEN ADJUSTMENT] is used to perform various adjustments.
- If [SCREEN ADJUSTMENT] and the adjustment in the [ADVANCED MENU] menu → [EDGE BLENDING] are used together, the edge blending may not be adjusted correctly depending on the environment.
- The image may disappear for a moment or may be disrupted while performing adjustment, but this is not a malfunction.

[ADVANCED MENU] menu

On the menu screen, select [ADVANCED MENU] from the main menu, and select an item from the sub-menu.

Refer to “Navigating through the menu” (➔ page 74) for the operation of the menu screen.

[DIGITAL CINEMA REALITY]

You can increase the vertical resolution and enhance the picture quality by performing cinema processing when the 1080/50i, 1080/60i signals are input.

- 1) Press ▲▼ to select [DIGITAL CINEMA REALITY].
- 2) Press ◀▶ to switch the item.
 - The items will switch each time you press the button.

[AUTO]	Automatically detects the signal and performs the cinema processing. (Factory default setting)	
[OFF]	Does not perform cinema processing.	
[30p FIXED]	When 1080/60i signal is input	Performs forced cinema processing (2:2 pulldown).
[25p FIXED]	When 1080/50i signal is input	

Note

- In [DIGITAL CINEMA REALITY], the picture quality will degrade when a signal other than the 2:2 pulldown is set as [25p FIXED] or [30p FIXED]. (Vertical resolution will degrade.)

[BLANKING]

You can adjust the blanking width if there are noises at the edge of the screen or the image is slightly running out from the screen while an image from the VCR or other devices are projected.

- 1) Press ▲▼ to select [BLANKING].
- 2) Press the <ENTER> button.
 - The [BLANKING] adjustment screen is displayed.
- 3) Press ▲▼ to select [UPPER], [LOWER], [LEFT], or [RIGHT].
- 4) Press ◀▶ to adjust the blanking width.

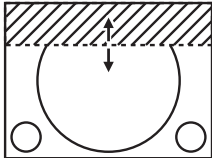
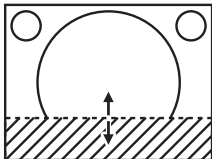
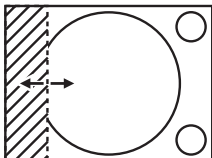
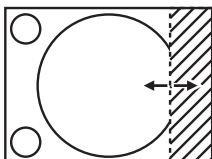
Blanking correction	Item	Operation	Adjustment	Range of adjustment	
Top of the screen	[UPPER]	Press ◀.	The blanking zone moves upward.		Top and bottom 0 - 599
		Press ▶.	The blanking zone moves downward.		
Bottom of the screen	[LOWER]	Press ▶.	The blanking zone moves upward.		
		Press ◀.	The blanking zone moves downward.		
Left side of the screen	[LEFT]	Press ▶.	The blanking zone moves to the right.		Left and right 0 - 959
		Press ◀.	The blanking zone moves to the left.		
Right side of the screen	[RIGHT]	Press ◀.	The blanking zone moves to the right.		
		Press ▶.	The blanking zone moves to the left.		

[INPUT RESOLUTION]

You can adjust the image to achieve an optimal image when there is a flickering image or smeared outlines.

- 1) Press ▲▼ to select [INPUT RESOLUTION].
- 2) Press the <ENTER> button.
 - The [INPUT RESOLUTION] screen is displayed.
- 3) Press ▲▼ to select [TOTAL DOTS], [DISPLAY DOTS], [TOTAL LINES], or [DISPLAY LINES], and press ◀▶ to adjust each item.
 - Values corresponding to the signal being input are displayed automatically for each item. Increase or decrease the displayed values and adjust to the optimal point while viewing the screen if there are vertical stripes or sections are missing from the screen.

Note

- Previously mentioned vertical banding will not occur with all white signal input.
- Image may be disrupted during automatic adjustment, but this is not a malfunction.
- [INPUT RESOLUTION] can be adjusted only when a RGB signal is input to the <COMPUTER IN> terminal.
- Adjustment may not be possible depending on the signal.

[EDGE BLENDING]

The edge blending function allows multiple images to be seamlessly overlapped by using the inclination of the brightness at the overlapped area.

It is recommended that edge blending is adjusted after an image is projected continuously for at least 30 minutes and then the image is stable.

When using [SCREEN ADJUSTMENT] to correct the distortion of the projected image, the adjustment areas of [NON-OVERLAPPED BLACK LEVEL], [BLACK BORDER LEVEL] and [OVERLAPPED BLACK LEVEL] do not match the actual image area. In this case, do not adjust [BRIGHTNESS ADJUST]. Adjust [BRIGHTNESS ADJUST] when [SCREEN ADJUSTMENT] is set to [OFF] or when [SCREEN ADJUSTMENT] is not used to correct the distortion of the projected image.

- 1) Press ▲▼ to select [EDGE BLENDING].
- 2) Press ◀▶ to switch the item.
 - The items will switch each time you press the button.

[OFF]	Sets the edge blending function to off.
[ON]	Use the setting value preset in the projector for the inclination of the edge blending area.

- Proceed to Step 3) when [ON] is selected.
- 3) Press the <ENTER> button.
 - The [EDGE BLENDING] screen is displayed.
 - 4) Press ▲▼ to specify the location to be corrected.
 - When joining at top: Set [UPPER] to [ON]
 - When joining at bottom: Set [LOWER] to [ON]
 - When joining at left: Set [LEFT] to [ON]
 - When joining at right: Set [RIGHT] to [ON]
 - 5) Press ◀▶ to switch to [ON].
 - 6) Press ▲▼ to select [START] or [WIDTH].
 - 7) Press ◀▶ to adjust the starting position or correction width.
 - 8) Press ▲▼ to select [MARKER].
 - 9) Press ◀▶ to switch to [ON].
 - A marker for image position adjustment is displayed. The position where the red and green lines overlap for the projectors to be joined will be the optimal point. Make sure to set the correction width for the projectors to be joined with the same value. Optimal joining is not possible with projectors that have different correction widths.

The optimal point is the point at which these lines overlap.

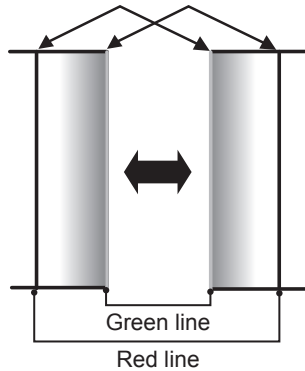

- 10) Press ▲▼ to select [BRIGHTNESS ADJUST].
- 11) Press the <ENTER> button.
 - The [BRIGHTNESS ADJUST] screen is displayed.
 - By setting [AUTO TESTPATTERN] to [ON] on the [EDGE BLENDING] screen, the black test pattern is displayed when you enter the [BRIGHTNESS ADJUST] screen.
- 12) Press ▲▼ to select [NON-OVERLAPPED BLACK LEVEL].
- 13) Press the <ENTER> button.
 - The [NON-OVERLAPPED BLACK LEVEL] screen is displayed.
 - [RED], [GREEN], and [BLUE] can be adjusted individually if [INTERLOCKED] is set to [OFF].
- 14) Press ▲▼ to select an item, and press ◀▶ to adjust the setting.
 - Once the adjustment is completed, press the <MENU> button to return to the [BRIGHTNESS ADJUST] screen.
- 15) Press ▲▼ to select [UPPER], [LOWER], [LEFT], or [RIGHT] in [BLACK BORDER WIDTH].
- 16) Press ◀▶ to set the region (width) of the [BLACK BORDER WIDTH] adjustment.
- 17) Press ▲▼ to select [UPPER KEYSTONE AREA], [LOWER KEYSTONE AREA], [LEFT KEYSTONE AREA], or [RIGHT KEYSTONE AREA].
- 18) Press ◀▶ to adjust the tilt of the border between [NON-OVERLAPPED BLACK LEVEL] and [BLACK BORDER LEVEL].
- 19) Press ▲▼ to select [BLACK BORDER LEVEL].
- 20) Press the <ENTER> button.
 - The [BLACK BORDER LEVEL] screen is displayed.
 - [RED], [GREEN], and [BLUE] can be adjusted individually if [INTERLOCKED] is set to [OFF].
- 21) Press ▲▼ to select an item, and press ◀▶ to adjust the setting.
 - Once the adjustment is completed, press the <MENU> button to return to the [BRIGHTNESS ADJUST] screen.
- 22) Press ▲▼ to select [UPPER], [LOWER], [LEFT], or [RIGHT] for [OVERLAPPED BLACK LEVEL].
- 23) Press the <ENTER> button.
 - The [OVERLAPPED BLACK LEVEL] screen is displayed.
 - [RED], [GREEN], and [BLUE] can be adjusted individually if [INTERLOCKED] is set to [OFF].
- 24) Press ▲▼ to select an item, and press ◀▶ to adjust the setting.

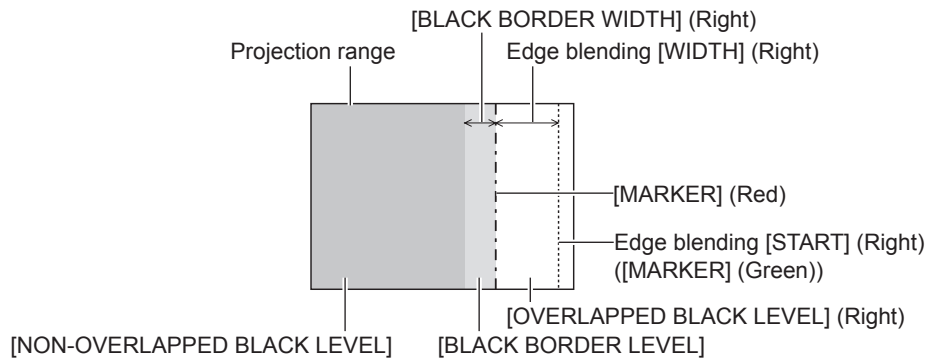

Note

- [BRIGHTNESS ADJUST] is a function that makes the increased brightness in black level of the overlapping image area difficult to notice when [EDGE BLENDING] is used to structure a multi-display screen. The optimal point of correction is set by adjusting [NON-OVERLAPPED BLACK LEVEL] so the black level of the overlapping image area will be the same level as the non-overlapping area. If the border area of the part where the image is overlapping and the non-overlapping part gets brighter after adjusting [NON-OVERLAPPED BLACK LEVEL], adjust the width of the top, bottom, left, or right. Adjust [BLACK BORDER LEVEL] when the width adjustment makes only the border area darker.
- The joining part may look discontinuous depending on the position you are looking from when a screen with high gain or rear screen is used.
- When structuring a multi-display screen using both horizontal and vertical edge blending, adjust [OVERLAPPED BLACK LEVEL] first before making adjustments in Step 12). Adjustment method is same as the procedure of [NON-OVERLAPPED BLACK LEVEL].
- If only horizontal or vertical edge blending is used, set all items in [OVERLAPPED BLACK LEVEL] to 0.
- The [AUTO TESTPATTERN] setting will change in conjunction with the setting in the [DISPLAY OPTION] menu → [COLOR ADJUSTMENT] → [AUTO TESTPATTERN].

[CLAMP POSITION]

You can adjust the optimal point when the black part of the image is blunt or it has turned green.

- 1) Press ▲▼ to select [CLAMP POSITION].
- 2) Press ◀▶ to adjust.

Status	Rough guide for optimal value	Range of adjustment
The black part is blunt.	The point where bluntness of the black part improves the most is the optimal value.	1 - 255
The black part is green.	The point where the green part becomes black, and the bluntness has improved is the optimal value.	

Note

- [CLAMP POSITION] can be adjusted only when a signal is input to the <COMPUTER IN> terminal.
- Adjustment may not be possible depending on the signal.

[RASTER POSITION]

This will allow the position of the image to move within the display area arbitrarily when the input image is not using the whole display area.

- 1) Press ▲▼ to select [RASTER POSITION].
- 2) Press the <ENTER> button.
 - The [RASTER POSITION] screen is displayed.
- 3) Press ▲▼◀▶ to adjust the position.



[DISPLAY LANGUAGE] menu

On the menu screen, select [DISPLAY LANGUAGE] from the main menu, and display the sub-menu. Refer to “Navigating through the menu” (➔ page 74) for the operation of the menu screen.

Changing the display language

You can select the language of the on-screen display.

- 1) Press ▲▼◀▶ to select the display language and press the <ENTER> button.

DISPLAY LANGUAGE	
● ENGLISH	MAGYAR
DEUTSCH	ROMANA
FRANÇAIS	ČESTINA
ITALIANO	РУССКИЙ
ESPAÑOL	TÜRKÇE
PORTUGUÊS	العربية
NEDERLANDS	Қазақша
SVENSKA	Hiện thị tiếng Việt
SUOMI	中文
NORSK	한국어
DANSK	日本語
POLSKI	ไทย
 SELECT  SET	

- Various menus, settings, adjustment screens, control button names, etc., are displayed in the selected language.
- The language can be switched to English, German, French, Italian, Spanish, Portuguese, Dutch, Swedish, Finnish, Norwegian, Danish, Polish, Hungarian, Romanian, Czech, Russian, Turkish, Arabic, Kazakh, Vietnamese, Chinese, Korean, Japanese, and Thai.

Note

- The on-screen display language is set to English in the factory default setting as well as when the [PROJECTOR SETUP] menu → [INITIALIZE] → [ALL USER DATA] is executed.

[DISPLAY OPTION] menu

On the menu screen, select [DISPLAY OPTION] from the main menu, and select an item from the sub-menu.

Refer to “Navigating through the menu” (➔ page 74) for the operation of the menu screen.

[COLOR ADJUSTMENT]

Correct the color difference between projectors when using multiple projectors simultaneously.

- 1) Press ▲▼ to select [COLOR ADJUSTMENT].
- 2) Press ◀▶ to switch the item.
 - The items will switch each time you press the button.

[OFF]	Does not perform the color adjustment.
[3COLORS]	Adjusts the three colors [RED], [GREEN], or [BLUE] and the white [GAIN].
[7COLORS]	Adjusts the seven colors [RED], [GREEN], [BLUE], [CYAN], [MAGENTA], [YELLOW], or [WHITE].

- 3) Select [3COLORS] or [7COLORS], and press the <ENTER> button.
 - The [3COLORS] or [7COLORS] screen is displayed.
- 4) Press ▲▼ to select [RED], [GREEN], [BLUE], or [WHITE] ([RED], [GREEN], [BLUE], [CYAN], [MAGENTA], [YELLOW], or [WHITE] when [7COLORS] is selected).
- 5) Press the <ENTER> button.
 - The [3COLORS:RED], [3COLORS:GREEN], [3COLORS:BLUE], or [3COLORS:WHITE] screen is displayed.
When [7COLORS] is selected, the [7COLORS:RED], [7COLORS:GREEN], [7COLORS:BLUE], [7COLORS:CYAN], [7COLORS:MAGENTA], [7COLORS:YELLOW], or [7COLORS:WHITE] screen is displayed.
 - By setting [AUTO TESTPATTERN] to [ON], the test pattern for the selected color is displayed.
- 6) Press ▲▼ to select [RED], [GREEN], or [BLUE].
 - Only [GAIN] can be adjusted when [WHITE] is selected for [3COLORS].
- 7) Press ◀▶ to adjust.
 - The adjustment value will change between 0*1 and 2 048.

*1 The lower limit varies depending on the color to be adjusted.

Note

- Operation when correcting the adjustment color
When the correction color same as the adjustment color is changed: The luminance of the adjustment color changes.
When correction color red is changed: Red is added to or subtracted from the adjustment color.
When correction color green is changed: Green is added to or subtracted from the adjustment color.
When correction color blue is changed: Blue is added to or subtracted from the adjustment color.
- Since advanced skills are necessary for the adjustment, this adjustment should be carried out by a person who is familiar with the projector or by a service person.
- Set [AUTO TESTPATTERN] to [ON] to automatically display a test pattern for use in adjusting the selected adjustment colors.
- The selected adjustment item will return to the factory default value when the <DEFAULT> button on the remote control is pressed.
- When [COLOR ADJUSTMENT] is set to anything other than [OFF], the [DISPLAY OPTION] menu → [COLOR CORRECTION] is fixed to [OFF], and the [PICTURE] menu → [COLOR TEMPERATURE] is fixed to [USER].

[COLOR CORRECTION]

Colors can be adjusted and registered for each input signal format.

- 1) Press ▲▼ to select [COLOR CORRECTION].
- 2) Press ◀▶ to switch the item.
 - The items will switch each time you press the button.

[OFF]	Standard setting
[USER]	For each of the signal formats of RGB, YC _B Cr/YP _B Pr, six colors of red, green, blue, cyan, magenta, and yellow can be adjusted and registered. Press the <ENTER> button and set the details. Adjustment is possible within the range of -31 to +31.

[SCREEN SETTING]

Set the screen size.

Correct to the optimum image position for the set screen when the aspect ratio of a projected image is changed. Set as necessary for the screen in use.

- 1) Press ▲▼ to select [SCREEN SETTING].
- 2) Press the <ENTER> button.
 - The [SCREEN SETTING] screen is displayed.
- 3) Press ◀▶ to switch the [SCREEN FORMAT] item.
 - The items will switch each time you press the button.

[SCREEN FORMAT]	Range when [SCREEN POSITION] is selected
[16:10]	Cannot be adjusted.
[4:3]	Adjusts the horizontal position between -160 and 160.
[16:9]	Adjusts the vertical position between -60 and 60.

- 4) Press ▲▼ to select [SCREEN POSITION].
 - [SCREEN POSITION] cannot be selected or adjusted when [SCREEN FORMAT] is set to [16:10].
- 5) Press ◀▶ to adjust [SCREEN POSITION].

[AUTO SIGNAL]

Set whether to execute automatic setup of signals automatically.

The screen display position or signal level can be adjusted automatically without pressing the <AUTO SETUP/CANCEL> button on the remote control on each occasion if you input unregistered signals frequently at meetings, etc.

- 1) Press ▲▼ to select [AUTO SIGNAL].
- 2) Press ◀▶ to switch the item.
 - The items will switch each time you press the button.

[OFF]	Sets the auto signal function to off.
[ON]	Executes automatic setup automatically when images are changed to unregistered signals during projection.

[AUTO SETUP]

Set this function when adjusting a special signal for still image signal, or horizontally long (such as 16:9) signal.

Setting with [MODE]

- 1) Press ▲▼ to select [AUTO SETUP].
- 2) Press the <ENTER> button.
 - The [AUTO SETUP] screen is displayed.
- 3) Press ▲▼ to select [MODE].
- 4) Press ◀▶ to switch the item.
 - The items will switch each time you press the button.

[DEFAULT]	Standard setting.
[WIDE]	Select this item when an image aspect ratio is a wide-screen signal, which does not meet the [DEFAULT] setting.
[USER]	Select this when receiving a signal with a special horizontal resolution (number of display dots).

- Proceed to Step 7) when [DEFAULT] or [WIDE] is selected.
- Proceed to Step 5) when [USER] is selected.

- 5) Press ▲▼ to select [DISPLAY DOTS], and press ◀▶ to match [DISPLAY DOTS] to the horizontal resolution of the signal source.
- 6) Press ▲▼ to select [MODE].
- 7) Press the <ENTER> button.
 - Automatic adjustment is executed. [PROGRESS] is displayed while in automatic adjustment. When completed, the screen returns to the [AUTO SETUP] screen.

Adjusting position automatically

- 1) Press ▲▼ to select [AUTO SETUP].
- 2) Press the <ENTER> button.
 - The [AUTO SETUP] screen is displayed.
- 3) Press ▲▼ to select [POSITION ADJUST].
- 4) Press ◀▶ to switch the item.

[ON]	Adjust the screen position and size when automatic setup is executed.
[OFF]	Does not perform automatic adjustment.

Note

- The automatic setup function may not operate properly unless a still image containing clear blacks and whites is input.

[COMPUTER IN]

Set the <COMPUTER IN> terminal.

Switching the slice level of an input synchronization signal

- 1) Press ▲▼ to select [COMPUTER IN].
- 2) Press the <ENTER> button.
 - The [COMPUTER IN] screen is displayed.
- 3) Press ▲▼ to select [SYNC SLICE LEVEL].
- 4) Press ◀▶ to switch the item.

[LOW]	Set the slice level to [LOW].
[HIGH]	Set the slice level to [HIGH].

Setting [EDID MODE] in [COMPUTER IN]

- 1) Press ▲▼ to select [COMPUTER IN].
- 2) Press the <ENTER> button.
 - The [COMPUTER IN] screen is displayed.
- 3) Press ▲▼ to select [EDID MODE].
- 4) Press the <ENTER> button.
 - The [EDID MODE] screen is displayed.
- 5) Press ◀▶ to switch the item.
 - The items will switch each time you press the button.

[DEFAULT]	Standard setting.
[SCREEN FIT]	Changes the EDID data according to the [SCREEN FORMAT] setting.
[USER]	Sets the [RESOLUTION] and [VERTICAL SCAN FREQUENCY] items as EDID.

- Proceed to Step 10) when [DEFAULT] or [SCREEN FIT] is selected.

- 6) Press the <ENTER> button.
 - The [RESOLUTION] screen is displayed.
- 7) Press ▲▼◀▶ to select [RESOLUTION].
 - Select [1024x768p], [1280x720p], [1280x800p], [1280x1024p], [1366x768p], [1400x1050p], [1440x900p], [1600x900p], [1600x1200p], [1680x1050p], [1920x1080p], [1920x1080i], or [1920x1200p].
- 8) Press the <ENTER> button.
 - The [VERTICAL SCAN FREQUENCY] screen is displayed.
- 9) Press ◀▶ to select [VERTICAL SCAN FREQUENCY].
 - Select [60Hz], [50Hz], [30Hz], [25Hz], or [24Hz] when [1920x1080p] is selected for [RESOLUTION].
 - Select [60Hz], [50Hz], or [48Hz] when [1920x1080i] is selected for [RESOLUTION].
 - Select [60Hz] or [50Hz] when anything other than following is selected for [RESOLUTION].
 - [1920x1080p], [1920x1080i]
- 10) Press the <ENTER> button.
 - The confirmation screen is displayed.
- 11) Press ◀▶ to select [OK], and press the <ENTER> button.

Note

- The content set in [RESOLUTION] and [VERTICAL SCAN FREQUENCY] is displayed in the [COMPUTER IN] screen.
- Setting of the resolution and the vertical scanning frequency may be necessary on the computer or video device in use.
- The computer, video device, or projector in use may require the power to be turned off and on again after setting.
- The output with the set resolution or vertical scanning frequency may not be possible depending on the computer or video device in use.

[HDMI IN]

Set this item in accordance with the video signal input to the <HDMI IN 1> terminal, <HDMI IN 2> terminal or the <HDMI IN 3> terminal.

Setting [SIGNAL LEVEL] in [HDMI IN]

- 1) Press ▲▼ to select [HDMI IN].
- 2) Press the <ENTER> button.
 - The [HDMI IN] screen is displayed.
- 3) Press ▲▼ to select [SIGNAL LEVEL] of [HDMI1], [HDMI2] or [HDMI3].
- 4) Press ◀▶ to switch the item.
 - The items will switch each time you press the button.

[AUTO]	Automatically sets the signal level.
[64-940]	Select this item when the signal output from the HDMI terminal of the external device (such as a Blu-ray disc player) is input to the <HDMI IN 1> terminal, <HDMI IN 2> terminal or the <HDMI IN 3> terminal.
[0-1023]	Select this item when the signal output from the DVI-D terminal of the external device (such as a computer) is input to the <HDMI IN 1> terminal, <HDMI IN 2> terminal or the <HDMI IN 3> terminal using a conversion cable, etc. Select this item also when the signal output from the HDMI terminal of a computer, etc., is input to the <HDMI IN 1> terminal, <HDMI IN 2> terminal or the <HDMI IN 3> terminal.

Note

- The optimal setting varies depending on the output setting of the connected external device. Refer to the operating instructions of the external device regarding the output of the external device.
- The HDMI signal level is displayed for 30 bits of input.

Setting [EDID SELECT] in [HDMI IN]

- 1) Press ▲▼ to select [HDMI IN].
- 2) Press the <ENTER> button.
 - The [HDMI IN] screen is displayed.

- 3) Press ▲▼ to select [EDID SELECT] of [HDMI1], [HDMI2] or [HDMI3].
- 4) Press ◀▶ to switch the item.
 - The items will switch each time you press the button.

[4K/60p]	Switches to EDID corresponding to the 4K video signal (maximum 4 096 x 2 160 dots, maximum vertical scanning frequency 60 Hz).
[4K/30p]	Switches to EDID corresponding to the 4K video signal (maximum 4 096 x 2 160 dots, maximum vertical scanning frequency 30 Hz).
[2K]	Switches to EDID corresponding to the 2K video signal (maximum 1 920 x 1 200 dots) or lower.

Note

- Switch the setting to [4K/30p] when proper image is not projected while [EDID SELECT] is set to [4K/60p] and the 4K video signal is input.
- Switch the setting to [2K] when proper image is not projected while [EDID SELECT] is set to [4K/60p] or [4K/30p] and the 2K video signal or lower is input.
- For details of the signal described in EDID of [4K/60p], [4K/30p], or [2K], refer to “List of plug and play compatible signals” (➔ page 206).

Setting [EDID MODE] in [HDMI IN]

- 1) Press ▲▼ to select [HDMI IN].
- 2) Press the <ENTER> button.
 - The [HDMI IN] screen is displayed.
- 3) Press ▲▼ to select [EDID MODE] of [HDMI1], [HDMI2] or [HDMI3].
- 4) Press the <ENTER> button.
 - The [HDMI1] screen, [HDMI2] screen or the [HDMI3] screen is displayed.
- 5) Press ◀▶ to switch the item.
 - The items will switch each time you press the button.

[DEFAULT]	Standard setting.
[SCREEN FIT]	Changes the EDID data according to the [SCREEN FORMAT] setting.
[USER]	Set the [RESOLUTION] and [VERTICAL SCAN FREQUENCY] items as EDID.

- Proceed to Step 10) when [DEFAULT] or [SCREEN FIT] is selected.
- 6) Press the <ENTER> button.
 - The [RESOLUTION] screen is displayed.
 - 7) Press ▲▼◀▶ to select [RESOLUTION].
 - Select [1024x768p], [1280x720p], [1280x800p], [1280x1024p], [1366x768p], [1400x1050p], [1440x900p], [1600x900p], [1600x1200p], [1680x1050p], [1920x1080p], [1920x1080i], or [1920x1200p].
 - 8) Press the <ENTER> button.
 - The [VERTICAL SCAN FREQUENCY] screen is displayed.
 - 9) Press ◀▶ to select [VERTICAL SCAN FREQUENCY].
 - Select [60Hz], [50Hz], [30Hz], [25Hz], or [24Hz] when [1920x1080p] is selected for [RESOLUTION].
 - Select [60Hz], [50Hz], or [48Hz] when [1920x1080i] is selected for [RESOLUTION].
 - Select [60Hz] or [50Hz] when anything other than following is selected for [RESOLUTION].
 - [1920x1080p], [1920x1080i]
 - 10) Press the <ENTER> button.
 - The confirmation screen is displayed.
 - 11) Press ◀▶ to select [OK], and press the <ENTER> button.

Note

- Settings in [RESOLUTION] and [VERTICAL SCAN FREQUENCY] are displayed in the [HDMI IN] screen.
- Setting of the resolution and the vertical scanning frequency may be necessary on the computer or video device in use.
- The computer, video device, or projector in use may require the power to be turned off and on again after setting.
- The output with the set resolution or vertical scanning frequency may not be possible depending on the computer or video device in use.

[DIGITAL LINK IN]

Set this item in accordance with the video signal input to the <DIGITAL LINK/LAN> terminal.

Setting [SIGNAL LEVEL] in [DIGITAL LINK IN]

- 1) Press ▲▼ to select [DIGITAL LINK IN].
- 2) Press the <ENTER> button.
 - The [DIGITAL LINK IN] screen is displayed.
- 3) Press ▲▼ to select [SIGNAL LEVEL].
- 4) Press ◀▶ to switch the item.
 - The items will switch each time you press the button.

[AUTO]	Automatically sets the signal level.
[64-940]	Select this item when the signal output from the HDMI terminal of an external device (Blu-ray disc player, etc.) is input to the <DIGITAL LINK/LAN> terminal via a twisted-pair-cable transmitter.
[0-1023]	Select this item when the signal output from the DVI-D terminal or HDMI terminal of an external device (such as a computer) is input to the <DIGITAL LINK/LAN> terminal via a twisted-pair-cable transmitter.

Note

- The optimal setting varies depending on the output setting of the connected external device. Refer to the operating instructions of the external device regarding the output of the external device.
- The signal level is displayed for 30 bits of input.

Setting [EDID SELECT] in [DIGITAL LINK IN]

- 1) Press ▲▼ to select [DIGITAL LINK IN].
- 2) Press the <ENTER> button.
 - The [DIGITAL LINK IN] screen is displayed.
- 3) Press ▲▼ to select [EDID SELECT] of [DIGITAL LINK IN].
- 4) Press ◀▶ to switch the item.
 - The items will switch each time you press the button.

[4K/60p]	Switches to EDID corresponding to the 4K video signal (maximum 4 096 x 2 160 dots, maximum vertical scanning frequency 60 Hz, and YPbPr 4:2:0 format only).
[4K/30p]	Switches to EDID corresponding to the 4K video signal (maximum 4 096 x 2 160 dots, maximum vertical scanning frequency 30 Hz).
[2K]	Switches to EDID corresponding to the 2K video signal (maximum 1 920 x 1 200 dots) or lower.

Note

- Switch the setting to [4K/30p] when proper image is not projected while [EDID SELECT] is set to [4K/60p] and the 4K video signal is input.
- Switch the setting to [2K] when proper image is not projected while [EDID SELECT] is set to [4K/60p] or [4K/30p] and the 2K video signal or lower is input.
- For details of the signal described in EDID of [4K/60p], [4K/30p], or [2K], refer to "List of plug and play compatible signals" (➔ page 206).

Setting [EDID MODE] in [DIGITAL LINK IN]

- 1) Press ▲▼ to select [DIGITAL LINK IN].
- 2) Press the <ENTER> button.
 - The [DIGITAL LINK IN] screen is displayed.
- 3) Press ▲▼ to select [EDID MODE].
- 4) Press the <ENTER> button.
 - The [DIGITAL LINK] screen is displayed.

5) Press ◀▶ to switch the item.

- The items will switch each time you press the button.

[DEFAULT]	Standard setting.
[SCREEN FIT]	Changes the EDID data according to the [SCREEN FORMAT] setting.
[USER]	Sets the [RESOLUTION] and [VERTICAL SCAN FREQUENCY] items as EDID.

- Proceed to Step 10) when [DEFAULT] or [SCREEN FIT] is selected.

6) Press the <ENTER> button.

- The [RESOLUTION] screen is displayed.

7) Press ▲▼◀▶ to select [RESOLUTION].

- Select [1024x768p], [1280x720p], [1280x800p], [1280x1024p], [1366x768p], [1400x1050p], [1440x900p], [1600x900p], [1600x1200p], [1680x1050p], [1920x1080p], [1920x1080i], or [1920x1200p].

8) Press the <ENTER> button.

- The [VERTICAL SCAN FREQUENCY] screen is displayed.

9) Press ◀▶ to switch [VERTICAL SCAN FREQUENCY].

- Select [60Hz], [50Hz], [30Hz], [25Hz], or [24Hz] when [1920x1080p] is selected for [RESOLUTION].
- Select [60Hz], [50Hz], or [48Hz] when [1920x1080i] is selected for [RESOLUTION].
- Select [60Hz] or [50Hz] when anything other than following is selected for [RESOLUTION].
 - [1920x1080p], [1920x1080i]

10) Press the <ENTER> button.

- The confirmation screen is displayed.

11) Press ◀▶ to select [OK], and press the <ENTER> button.

Note

- Settings in [RESOLUTION] and [VERTICAL SCAN FREQUENCY] are displayed in the [DIGITAL LINK IN] screen.
- Setting of the resolution and the vertical scanning frequency may be necessary on the computer or video device in use.
- The computer, video device, or projector in use may require the power to be turned off and on again after setting.
- The output with the set resolution or vertical scanning frequency may not be possible depending on the computer or video device in use.

[ON-SCREEN DISPLAY]

Set the on-screen display.

Setting [OSD POSITION]

Set the position of the menu screen (OSD).

1) Press ▲▼ to select [ON-SCREEN DISPLAY].

2) Press the <ENTER> button.

- The [ON-SCREEN DISPLAY] screen is displayed.

3) Press ▲▼ to select [OSD POSITION].

4) Press ◀▶ to switch the item.

- The items will switch each time you press the button.

[2]	Sets to the center left of the screen.
[3]	Sets to the bottom left of the screen.
[4]	Sets to the top center of the screen.
[5]	Sets to the center of the screen.
[6]	Sets to the bottom center of the screen.
[7]	Sets to the upper right of the screen.
[8]	Sets to the center right of the screen.
[9]	Sets to the bottom right of the screen.
[1]	Sets to the upper left of the screen.

Setting [OSD SIZE]

Set the display size of the menu screen (OSD).

- 1) Press ▲▼ to select [ON-SCREEN DISPLAY].
- 2) Press the <ENTER> button.
 - The [ON-SCREEN DISPLAY] screen is displayed.
- 3) Press ▲▼ to select [OSD SIZE].
- 4) Press ◀▶ to switch the item.
 - The items will switch each time you press the button.

[NORMAL]	Select this item normally.
[DOUBLE]	Displays the menu screen in the font size double of when set to [NORMAL]. The size of the menu screen is doubled horizontally and vertically.

Setting [OSD ROTATION]

Set the orientation of the menu screen (OSD).

- 1) Press ▲▼ to select [ON-SCREEN DISPLAY].
- 2) Press the <ENTER> button.
 - The [ON-SCREEN DISPLAY] screen is displayed.
- 3) Press ▲▼ to select [OSD ROTATION].
- 4) Press ◀▶ to switch the item.
 - The items will switch each time you press the button.

[OFF]	Does not rotate the screen.
[CLOCKWISE]	Rotates the screen by 90° clockwise.
[COUNTERCLOCKWISE]	Rotates the screen by 90° counterclockwise.

Setting [OSD COLOR]

Set the color of the menu screen (OSD).

- 1) Press ▲▼ to select [ON-SCREEN DISPLAY].
- 2) Press the <ENTER> button.
 - The [ON-SCREEN DISPLAY] screen is displayed.
- 3) Press ▲▼ to select [OSD COLOR].
- 4) Press ◀▶ to switch the item.
 - The items will switch each time you press the button.

[1]	Sets the background color to light blue and the selection color to yellow.
[2]	Sets the background color to dark blue and the selection color to blue.
[3]	Sets the background color to gray and the selection color to white.
[4]	Sets the background color to green and the selection color to light green.
[5]	Sets the background color to brown and the selection color to pink.
[6]	Sets the background color to light brown and the selection color to skin tone.

Setting [OSD MEMORY]

Set hold for the position of the menu screen (OSD) cursor.

- 1) Press ▲▼ to select [ON-SCREEN DISPLAY].
- 2) Press the <ENTER> button.
 - The [ON-SCREEN DISPLAY] screen is displayed.

- 3) Press ▲▼ to select [OSD MEMORY].
- 4) Press ◀▶ to switch the item.
 - The items will switch each time you press the button.

[ON]	Holds the cursor position.
[OFF]	Does not hold the cursor position.

Note

- Even if [ON] is set, the cursor position is not maintained when the power is turned off.

Setting [INPUT GUIDE]

Set whether to display the input guide in the position set in [OSD POSITION].

Input guide is a screen to display information such as the currently selected input terminal name, signal name, memory number, etc.

- 1) Press ▲▼ to select [ON-SCREEN DISPLAY].
- 2) Press the <ENTER> button.
 - The [ON-SCREEN DISPLAY] screen is displayed.
- 3) Press ▲▼ to select [INPUT GUIDE].
- 4) Press ◀▶ to switch the item.
 - The items will switch each time you press the button.

[ON]	Displays the input guide.
[OFF]	Hides the input guide.

Setting [WARNING MESSAGE]

Set the display/hide of the warning message.

- 1) Press ▲▼ to select [ON-SCREEN DISPLAY].
- 2) Press the <ENTER> button.
 - The [ON-SCREEN DISPLAY] screen is displayed.
- 3) Press ▲▼ to select [WARNING MESSAGE].
- 4) Press ◀▶ to switch the item.
 - The items will switch each time you press the button.

[ON]	Displays the warning message.
[OFF]	Hides the warning message.

Note

- When [OFF] is set, a warning message is not displayed on the projected image even if a warning condition such as [TEMPERATURE WARNING] is detected while using the projector.
The message prompting to clean/replace the filter is not displayed either.

[SIGNAL SEARCH]

Enable/disable the signal search function.

If the signal search function is enabled, the input with input signal is automatically selected and projection is started when the projector is turned on. Also, when the currently selected input has no signal, the projector will automatically switch to the input with input signal when the <AUTO SETUP/CANCEL> button is pressed.

- 1) Press ▲▼ to select [SIGNAL SEARCH].
- 2) Press ◀▶ to switch the item.
 - The items will switch each time you press the button.

[ON]	Enables the signal search function.
[OFF]	Disables the signal search function.

[BACK COLOR]

Set the display of the projected screen when there is no signal input.

- 1) Press ▲▼ to select [BACK COLOR].
- 2) Press ◀▶ to switch the item.
 - The items will switch each time you press the button.

[BLUE]	Displays the entire projection area in blue.
[BLACK]	Displays the entire projection area in black.
[DEFAULT LOGO]	Displays the Panasonic logo.
[USER LOGO]	Displays the image registered by the user.

Note

- To create and register the [USER LOGO] image, use "Logo Transfer Software". The software can be downloaded from the website (<https://panasonic.net/cns/projector/>).

[STARTUP LOGO]

Set the logo display when the power is turned on.

- 1) Press ▲▼ to select [STARTUP LOGO].
- 2) Press ◀▶ to switch the item.
 - The items will switch each time you press the button.

[DEFAULT LOGO]	Displays the Panasonic logo.
[USER LOGO]	Displays the image registered by the user.
[NONE]	Disables the startup logo display.

Note

- When [USER LOGO] is selected, the display of the startup logo will be kept for approximately 15 seconds.
- To create and register the [USER LOGO] image, use "Logo Transfer Software". The software can be downloaded from the website (<https://panasonic.net/cns/projector/>).
- If the [PROJECTOR SETUP] menu → [ECO MANAGEMENT] → [QUICK STARTUP] is set to [ON], the startup logo is not displayed when projection starts before the specified time elapses after the projector enters the standby mode. The specified time is a time set in the [PROJECTOR SETUP] menu → [ECO MANAGEMENT] → [QUICK STARTUP] → [VALID PERIOD].

[UNIFORMITY]

Correct the brightness unevenness and color unevenness of the entire screen.

Setting [USER CORRECTION]

Correct the brightness unevenness and color unevenness of the entire screen as desired.

- 1) Press ▲▼ to select [UNIFORMITY].
- 2) Press the <ENTER> button.
 - The [UNIFORMITY] screen is displayed.
- 3) Press ▲▼ to select [USER CORRECTION].
- 4) Press ◀▶ to switch the item.
 - The items will switch each time you press the button.

[OFF]	Disables the user correction function.
[ON]	Enables the user correction function.

- Proceed to Step 5) if [ON] is selected.

- 5) Press the <ENTER> button.
 - The [UNIFORMITY:USER CORRECTION] screen is displayed.
- 6) Press ▲▼ to select [ADJUSTMENT LEVEL].
- 7) Press ◀▶ to switch the item.
 - The items will switch each time you press the button.

[1] - [8]	Select the signal level (target brightness to adjust). The entire screen becomes darker when the value gets larger.
-----------	--

- If you press ▶ while the adjustment level is [8], the level will become [1]. If you press ◀ while the adjustment level is [1], the level will become [8].

- 8) Press ▲▼ to select [TEST PATTERN].
- 9) Press ◀▶ to switch the item.
 - The items will switch each time you press the button.

[ON]	Displays the test pattern.
[OFF]	Does not display the test pattern.

- 10) Press ▲▼ to select the adjustment area ([UPPER LEFT], [UPPER RIGHT], [LOWER LEFT], [LOWER RIGHT], [UPPER], [LOWER], [LEFT], or [RIGHT]).
- 11) Press the <ENTER> button.
 - The adjustment screen of [RED], [GREEN], or [BLUE] for the item selected in Step 10) is displayed.
- 12) Press ▲▼ to select [RED], [GREEN], or [BLUE].
- 13) Press ◀▶ to adjust the level.

Item	Operation	Adjustment	Range of adjustment
[RED]	Press ▶.	Red becomes darker.	-31 - +31 (Factory default setting: 0)
	Press ◀.	Red becomes lighter.	
[GREEN]	Press ▶.	Green becomes darker.	
	Press ◀.	Green becomes lighter.	
[BLUE]	Press ▶.	Blue becomes darker.	
	Press ◀.	Blue becomes lighter.	

- To adjust the color unevenness for each adjustment level, repeat Steps 6) to 13).
- To adjust the color unevenness for each adjustment area, repeat Steps 10) to 13).

Initializing adjustments for [USER CORRECTION]

Return the color unevenness settings of all adjustment areas in the specified [ADJUSTMENT LEVEL] to the factory default values.

- 1) Press ▲▼ to select [UNIFORMITY].
- 2) Press the <ENTER> button.
 - The [UNIFORMITY] screen is displayed.
- 3) Press ▲▼ to select [USER CORRECTION].
- 4) Press ◀▶ to select [ON], and press the <ENTER> button.
 - The [UNIFORMITY:USER CORRECTION] screen is displayed.
- 5) Press ▲▼ to select [ADJUSTMENT LEVEL].
- 6) Press ◀▶ to switch the [ADJUSTMENT LEVEL] to initialize.
- 7) Press ▲▼ to select [INITIALIZE].
- 8) Press the <ENTER> button.
 - The confirmation screen is displayed.

9) Press ◀▶ to select [OK], and press the <ENTER> button.

Note

- To initialize all settings in [USER CORRECTION] in one time, select [PROJECTOR SETUP] menu → [INITIALIZE] → [ALL USER DATA] or [UNIFORMITY] and execute the initialization.
- [TEST PATTERN] is not initialized.

Setting [ZOOM CORRECTION]

Color unevenness may change depending on the zoom position of the lens. Change the setting according to the zoom position so that color unevenness is minimized.

- 1) Press ▲▼ to select [UNIFORMITY].
- 2) Press the <ENTER> button.
 - The [UNIFORMITY] screen is displayed.
- 3) Press ▲▼ to select [ZOOM CORRECTION].
- 4) Press ◀▶ to adjust the zoom correction.
 - The items will switch each time you press the button.

[0]	Select [0] when the lens is at the wide end (W) for the best color unevenness correction.
[1] - [7]	Select from [1] to [7] for the best color unevenness correction.
[8]	Select [8] when the lens is at the tele end (T) for the best color unevenness correction.

[SHUTTER SETTING]

Set the operation of the shutter function.

Setting [FADE-IN] or [FADE-OUT]

- 1) Press ▲▼ to select [SHUTTER SETTING].
- 2) Press the <ENTER> button.
 - The [SHUTTER SETTING] screen is displayed.
- 3) Press ▲▼ to select [FADE-IN] or [FADE-OUT].
- 4) Press ◀▶ to switch the item.

Item		Adjustment
[FADE-IN] [FADE-OUT]	[OFF]	Does not set fade-in or fade-out.
	[0.5s] - [10.0s]	Sets the fade-in or fade-out time. Select an item from [0.5s] - [4.0s], [5.0s], [7.0s], or [10.0s]. [0.5s] - [4.0s] can be selected in increments of 0.5.

Note

- If the <SHUTTER> button on the remote control is pressed during fade-in or fade-out, the fade operation is canceled.
- Fade-in/fade-out is not performed on the audio. Audio is output or paused linked to the operation of the shutter function.

Setting [STARTUP]

Automatically enable/disable the shutter function (shutter: closed/open) when the power is turned on.

- 1) Press ▲▼ to select [SHUTTER SETTING].
- 2) Press the <ENTER> button.
 - The [SHUTTER SETTING] screen is displayed.
- 3) Press ▲▼ to select [STARTUP].
- 4) Press ◀▶ to switch the item.

[OPEN]	The projector goes into projection mode with the shutter function disabled (shutter: opened) when the power is turned on.
[CLOSE]	The projector goes into projection mode with the shutter function enabled (shutter: closed) when the power is turned on.

Using the shutter function

Image and audio is turned off when the projector is not used for a specific time.

- 1) Press ▲▼ to select [SHUTTER SETTING].
- 2) Press the <ENTER> button.
 - The [SHUTTER SETTING] screen is displayed.
- 3) Press ▲▼ to select [SHUTTER].
- 4) Press the <ENTER> button.
 - Press the <MENU> button or the <RETURN> button to clear.

Note

- The power indicator <ON (G)/STANDBY (R)> will blink green slowly while the shutter function is in use (shutter: closed).
- To output audio while the shutter function is in use (shutter: closed), set the [PROJECTOR SETUP] menu → [AUDIO SETTING] → [IN SHUTTER] to [ON].

[P-TIMER]

Set and operate the presentation timer function.

Setting the mode

- 1) Press ▲▼ to select [P-TIMER].
- 2) Press the <ENTER> button.
 - The [P-TIMER] screen is displayed.
- 3) Press ▲▼ to select [MODE].
- 4) Press ◀▶ to switch the item.
 - The items will switch each time you press the button.

[COUNT UP]	Displays the elapsed time from when the count is started.
[COUNT DOWN]	Displays the remaining time against the time set in [TIMER].

Setting the countdown timer

- 1) Press ▲▼ to select [P-TIMER].
- 2) Press the <ENTER> button.
 - The [P-TIMER] screen is displayed.
- 3) Press ▲▼ to select [TIMER].
- 4) Press ◀▶ to set the time.
 - The time can be set from 1 minute to 180 minutes in one-minute interval.
 - The factory default setting is 10 minutes.

Note

- [TIMER] can be set when [MODE] is set to [COUNT DOWN].

Using the presentation timer

- 1) Press ▲▼ to select [P-TIMER].

- 2) Press the <ENTER> button.
 - The [P-TIMER] screen is displayed.
- 3) Press ▲▼ to select an item, and press the <ENTER> button.

[START]	Starts the count.
[STOP]	Stops the count.
[RESTART]	Restarts the count.
[RESET]	Resets the count.
[EXIT]	Ends the presentation timer.

- Elapsed time or remaining time is displayed in the bottom right of the projected image when [START] or [RESTART] is selected.
- The elapsed time or remaining time when it was stopped is displayed in the bottom right of the projected image when [STOP] is selected.

Note

- The presentation timer can be operated by the <P-TIMER> button on the remote control. (➡ page 70)
- The security message set in the [SECURITY] menu → [DISPLAY SETTING] (➡ page 133) is not displayed while the elapsed time or remaining time is displaying.
- The elapsed time or remaining time is not displayed while the menu screen is displayed.
- When [MODE] is set to [COUNT UP], the start time will be "000:00".
- When [MODE] is set to [COUNT DOWN], the start time will be the value set in [TIMER].
- The timer gauge will turn clockwise when set to [COUNT UP], and turn counterclockwise when set to [COUNT DOWN].

[FREEZE]

The projected image is paused and audio is turned off regardless of the playback of the external device.

- 1) Press ▲▼ to select [FREEZE].
- 2) Press the <ENTER> button.
 - Press the <MENU> button or the <RETURN> button to clear.

Note

- [FREEZE] is displayed on the screen when video is paused.
- Operation of [FREEZE] can also be performed with the <FREEZE> button on the remote control. (➡ page 67)

[DIGITAL ZOOM]

(When RGB signal for still images, HDMI signal for still images, or DIGITAL LINK signal for still images is input.)

- 1) Press ▲▼ to select [DIGITAL ZOOM].
- 2) Press the <ENTER> button.
 - The [DIGITAL ZOOM] individual adjustment screen is displayed.
- 3) Press ◀▶ to adjust the magnification factor.
 - The magnification factor can be adjusted from 1.0 times to 3.0 times in 0.1 intervals.
- 4) Press the <ENTER> button.
 - The move screen is displayed.
- 5) Moving the enlargement area
 - For details, refer to "Using the digital zoom function" (➡ page 69).

Note

- The digital zoom is canceled when the <AUTO SETUP/CANCEL> button on the remote control or the <LENS/CANCEL> button on the control panel is pressed while performing the digital zoom.
- The adjustment value of the digital zoom is canceled when the type of input signal is changed while performing the digital zoom.
- The freeze function is disabled while performing the digital zoom.
- The digital zoom will not operate in some of the still image signals.

[PROJECTOR SETUP] menu

On the menu screen, select [PROJECTOR SETUP] from the main menu, and select an item from the sub-menu.

Refer to “Navigating through the menu” (➔ page 74) for the operation of the menu screen.

[PROJECTOR ID]

The projector has an ID number setting function that can be used when multiple projectors are used side by side to enable simultaneous control or individual control via a single remote control.

- 1) Press ▲▼ to select [PROJECTOR ID].
- 2) Press ◀▶ to switch the item.
 - The items will switch each time you press the button.

[ALL]	Select this item when controlling projectors without specifying an ID number.
[1] - [64]	Select this item when specifying an ID number to control individual projector.

Note

- To specify an ID number for individual control, the ID number of a remote control must match the ID number of the projector.
- When the ID number is set to [ALL], the projector will operate regardless of the ID number specified during remote control or computer control.
If multiple projectors are set up side by side with IDs set to [ALL], they cannot be controlled separately from the projectors with other ID numbers.
- Refer to “Setting ID number of the remote control” (➔ page 72) for how to set the ID number on the remote control.

[PROJECTION METHOD]

Set the projection method in accordance with the installation status of the projector.

Change the [FRONT/REAR] setting when the screen display is inverted.

Change the [FLOOR/CEILING] setting when the screen display is upside down.

Setting [FRONT/REAR]

- 1) Press ▲▼ to select [FRONT/REAR] of [PROJECTION METHOD].
- 2) Press ◀▶ to switch the item.
 - The items will switch each time you press the button.

[FRONT]	Select this item when installing the projector in front of the screen.
[REAR]	Select this item when installing behind the screen (using translucent screen).

Setting [FLOOR/CEILING]

- 1) Press ▲▼ to select [FLOOR/CEILING] of [PROJECTION METHOD].
- 2) Press ◀▶ to switch the item.
 - The items will switch each time you press the button.

[AUTO]	Automatically detects the attitude of the projector by the built-in angle sensor. Set [AUTO] normally.
[FLOOR]	Select this item when installing the projector on a desk, etc.
[CEILING]	Select this item when installing the projector using the Ceiling Mount Bracket (optional). Projected image is inverted upside down.

Note

- For the range of installation attitude detected by the built-in angle sensor, refer to “Angle sensor” (➔ page 37).

[ECO MANAGEMENT]

Set [ECO MANAGEMENT] to reduce the power consumption and enhance the life of the light source.

Setting [LIGHT POWER]

- 1) Press ▲▼ to select [ECO MANAGEMENT].
- 2) Press the <ENTER> button.
 - The [ECO MANAGEMENT] screen is displayed.
- 3) Press ▲▼ to select [LIGHT POWER].
- 4) Press ◀▶ to switch the item.
 - The items will switch each time you press the button.

[NORMAL]	Select this item when high luminance is required. The light power is 100 % and the estimated runtime is approximately 20 000 hours*1.
[ECO]	The luminance will decrease compared to [NORMAL], but select this item to suppress the reduction in luminance against the runtime of the light source. The light power is 70 % and the estimated runtime is approximately 24 000 hours*1.
[QUIET]	Select this item to prioritize the operation with low noise. The light power is 70 % and the estimated runtime is approximately 20 000 hours*1.
[USER]	Select the item to set the picture brightness as desired.

*1 The runtime is an estimation when the [PICTURE] menu → [DYNAMIC CONTRAST] is set to [2].

- Proceed to Step 5) when [USER] is selected.

- 5) Press ▲▼ to select [LIGHT OUTPUT].
- 6) Press ◀▶ to adjust.

Operation	Adjustment		Range of adjustment
	Brightness	Runtime (estimate)	
Press ▶.	The screen becomes brighter.	The runtime becomes shorter.	30 %*1 - 100 %
Press ◀.	The screen becomes darker.	The runtime becomes longer.	

*1 It should be noted that the picture quality tends to deteriorate as the light output decreases.

Note

- Under influences of characteristics of each light source, conditions of use, installation environment, etc., the runtime may be shorter than the estimation.
- Runtime is a time until the luminance of the light source to become about half when using the projector continuously. The runtime is just an estimate, and is not the warranty period.
- If the runtime exceeds 10 000 hours, replacement of the components inside the projector may be required. Consult your dealer for details.

Setting [AMBIENT LIGHT DETECTION]

Sets if the [AMBIENT LIGHT DETECTION] function to adjust the light power depending on the brightness of the installed location is enabled or not.

- 1) Press ▲▼ to select [ECO MANAGEMENT].
- 2) Press the <ENTER> button.
 - The [ECO MANAGEMENT] screen is displayed.
- 3) Press ▲▼ to select [AMBIENT LIGHT DETECTION].
- 4) Press ◀▶ to switch the item.
 - The items will switch each time you press the button.

[OFF]	Disables the ambient light detection function.
[ON]	Enables the ambient light detection function.

Note

- The luminance may not be detected correctly when an object is placed on top of the projector, blocking the luminance sensor. In such a case, it may not operate properly even if [AMBIENT LIGHT DETECTION] is set to [ON].

Setting [SIGNAL DETECTION]

Set if the [SIGNAL DETECTION] function to reduce the power of the light source during no signal is enabled or not.

- 1) Press ▲▼ to select [ECO MANAGEMENT].
- 2) Press the <ENTER> button.
 - The [ECO MANAGEMENT] screen is displayed.
- 3) Press ▲▼ to select [SIGNAL DETECTION].
- 4) Press ◀▶ to switch the item.
 - The items will switch each time you press the button.

[OFF]	Disables the [SIGNAL DETECTION] function.
[ON]	Enables the [SIGNAL DETECTION] function.

Setting [POWER MANAGEMENT]

This is a function to set the power of the projector to standby state or ready state automatically when there is no input signal for specific time. Selection of standby state or the ready state, and the time for the power management function to operate can be set.

- 1) Press ▲▼ to select [ECO MANAGEMENT].
- 2) Press the <ENTER> button.
 - The [ECO MANAGEMENT] screen is displayed.
- 3) Press ▲▼ to select [POWER MANAGEMENT].
- 4) Press ◀▶ to switch the item.
 - The items will switch each time you press the button.

[SHUT DOWN]	The countdown timer is displayed when the signal input is not present for 30 seconds, and the light source is turned off, and goes into standby after cooling when the time set in [TIMER] has elapsed.
[OFF]	Disables the power management function.
[READY]	The countdown timer is displayed when the signal input is not present for 30 seconds, and the light source is turned off, and goes into ready state after cooling when the time set in [TIMER] has elapsed. The light source will turn on and starts projection when a signal is input or the button is operated while in ready state.

- Proceed to Step 5) when anything other than [OFF] is selected.

- 5) Press the <ENTER> button.
 - The [POWER MANAGEMENT] screen is displayed.
- 6) Press ◀▶ to set the time for [TIMER].
 - The setting time will switch each time you press the button.
 - The time for the power management function to operate can be set from 5 minutes to 120 minutes in five-minute interval.

Setting [STANDBY MODE]

Set the power consumption during standby and whether to enable the [QUICK STARTUP] function.

- 1) Press ▲▼ to select [ECO MANAGEMENT].
- 2) Press the <ENTER> button.
 - The [ECO MANAGEMENT] screen is displayed.
- 3) Press ▲▼ to select [STANDBY MODE].
- 4) Press ◀▶ to switch the item.
 - The items will switch each time you press the button.

[NORMAL]	Select this item when using the network function during standby.
[ECO]	Select this item to reduce power consumption during standby.

- Proceed to Step 5) when [NORMAL] is selected.

5) Press ▲▼ to select [QUICK STARTUP].

6) Press ◀▶ to switch the item.

- The items will switch each time you press the button.

[OFF]	Disables the [QUICK STARTUP] function.
[ON]	Enables the [QUICK STARTUP] function until the specified time set in [VALID PERIOD] elapses after the projector enters the standby mode. The time until the projection starts after the power is turned on will be reduced during the period when the [QUICK STARTUP] function is valid.

- Proceed to Step 7) when [ON] is selected.

7) Press the <ENTER> button.

- The [QUICK STARTUP] screen is displayed.

8) Press ◀▶ to switch [VALID PERIOD].

- The items will switch each time you press the button.

[30MIN.]	Sets the time until the [QUICK STARTUP] function is disabled after the projector enters the standby mode. Select a desired valid period.
[60MIN.]	
[90MIN.]	

Note

- When [STANDBY MODE] is set to [NORMAL], the network function can be used during standby.
- When [STANDBY MODE] is set to [ECO], the network function and the audio output function cannot be used during standby. Also, some RS-232C commands cannot be used.
- When [STANDBY MODE] is set to [ECO], it takes longer for the projection to start after the power is turned on, compared to when set to [NORMAL].
- [STANDBY MODE] is fixed to [NORMAL] when the [PROJECTOR SETUP] menu → [SCHEDULE] is set to [ON].
- [QUICK STARTUP] cannot be set when [STANDBY MODE] is set to [ECO].
- When [QUICK STARTUP] is set to [ON], the power consumption during standby becomes high during the period when the [QUICK STARTUP] function is valid.
- If [QUICK STARTUP] is set to [ON], the [QUICK STARTUP] function is disabled when the time set in [VALID PERIOD] elapses after the projector enters the standby mode. The startup time and power consumption will be the same as when [QUICK STARTUP] is set to [OFF].
- When [QUICK STARTUP] is set to [ON], the power indicator <ON (G)/STANDBY (R)> blinks red while in the standby mode during the period when the [QUICK STARTUP] function is valid. When [IN STANDBY MODE] in [AUDIO SETTING] is set to [OFF], the power indicator <ON (G)/STANDBY (R)> will change to a red light when the specified time set in [VALID PERIOD] elapses after the projector enters the standby mode.
- When [QUICK STARTUP] is set to [ON], the period when the [QUICK STARTUP] function is valid will be added as the projector runtime.

[INITIAL STARTUP]

Set the startup method when the <MAIN POWER> switch is set to <ON>.

1) Press ▲▼ to select [INITIAL STARTUP].

2) Press ◀▶ to switch the item.

- The items will switch each time you press the button.

[LAST MEMORY]	Starts up the projector in the condition before the <MAIN POWER> switch is set to <OFF>.
[STANDBY]	Starts up the projector in standby.
[ON]	Starts projecting immediately.

[STARTUP INPUT SELECT]

Set the input when the projector is switched on to start projection.

1) Press ▲▼ to select [STARTUP INPUT SELECT].

2) Press the <ENTER> button.

- The [STARTUP INPUT SELECT] screen is displayed.

- 3) Press **▲▼◀▶** to select the input, and press the **<ENTER>** button.

[LAST USED]	Keeps the input selected last.
[COMPUTER]	Sets the input to COMPUTER.
[HDMI1]	Sets the input to HDMI1.
[HDMI2]	Sets the input to HDMI2.
[HDMI3]	Sets the input to HDMI3.
[DIGITAL LINK]	Sets the input to DIGITAL LINK.
[INPUT1] - [INPUT10]*1	Sets the input to DIGITAL LINK, and switches the input of the DIGITAL LINK output supported device to the specified input.

*1 When the optional DIGITAL LINK output supported device (Model No.: ET-YFB100G, ET-YFB200G) is connected to the projector, its input name is automatically reflected from [INPUT1] to [INPUT10]. When an item that does not reflect the input name is selected, it will be disabled.

[DATE AND TIME]

Set the time zone, date, and time of the built-in clock of the projector.

Setting the time zone

- 1) Press **▲▼** to select [DATE AND TIME].
- 2) Press the **<ENTER>** button.
 - The [DATE AND TIME] screen is displayed.
- 3) Press **▲▼** to select [TIME ZONE].
- 4) Press **◀▶** to switch [TIME ZONE].

Setting the date and time manually

- 1) Press **▲▼** to select [DATE AND TIME].
- 2) Press the **<ENTER>** button.
 - The [DATE AND TIME] screen is displayed.
- 3) Press **▲▼** to select [ADJUST CLOCK].
- 4) Press the **<ENTER>** button.
 - The [ADJUST CLOCK] screen is displayed.
- 5) Press **▲▼** to select an item, and press **◀▶** to set the local date and time.
- 6) Press **▲▼** to select [APPLY], and press the **<ENTER>** button.
 - The setting of the date and time will be completed.

Setting the date and time automatically

- 1) Press **▲▼** to select [DATE AND TIME].
- 2) Press the **<ENTER>** button.
 - The [DATE AND TIME] screen is displayed.
- 3) Press **▲▼** to select [ADJUST CLOCK].
- 4) Press the **<ENTER>** button.
 - The [ADJUST CLOCK] screen is displayed.
- 5) Press **▲▼** to select [NTP SYNCHRONIZATION], and press **◀▶** to change the setting to [ON].
- 6) Press **▲▼** to select [APPLY], and press the **<ENTER>** button.
 - The setting of the date and time will be completed.

Note

- To set the date and time automatically, the projector must be connected to the network.

- If synchronization with the NTP server fails just after [NTP SYNCHRONIZATION] is set to [ON], [NTP SYNCHRONIZATION] will return to [OFF]. If [NTP SYNCHRONIZATION] is set to [ON] while the NTP server is not set, [NTP SYNCHRONIZATION] will return to [OFF].
- Access the projector via a web browser to set the NTP server. Refer to “[Adjust clock] page” (➔ page 157) for details.
- The [TIME ZONE] setting is reset to the factory default when the [PROJECTOR SETUP] menu → [INITIALIZE] → [ALL USER DATA] is executed. However, the date and time based on the local date and time setting (Coordinated Universal Time, UTC, Universal Time, Coordinated) will be maintained without being initialized.

[SCHEDULE]

Set the command execution schedule for each day of the week.

Enabling/disabling the schedule function

- 1) Press ▲▼ to select [SCHEDULE].
- 2) Press ◀▶ to switch the item.
 - The items will switch each time you press the button.

[OFF]	Disables the schedule function.
[ON]	Enables the schedule function. Refer to “How to assign a program” (➔ page 115) or “How to set a program” (➔ page 115) for how to set the schedule.

Note

- The [STANDBY MODE] setting will be forced to [NORMAL] when the [PROJECTOR SETUP] menu → [ECO MANAGEMENT] → [STANDBY MODE] is set to [ECO], and [SCHEDULE] is set to [ON]. Changing the setting to [ECO] is not available. The [STANDBY MODE] setting will not change back even when [SCHEDULE] is set to [OFF] in this condition.

How to assign a program

- 1) Press ▲▼ to select [SCHEDULE].
- 2) Press ◀▶ to select [ON], and press the <ENTER> button.
 - The [SCHEDULE] screen is displayed.
- 3) Select and assign a program to each day of week.
 - Press ▲▼ to select the day of week, and press ◀▶ to select a program number.
 - You can set the program from No.1 to No.7. “- - -” indicates that the program number has not been set.

How to set a program

Set up to 16 commands to each program.

- 1) Press ▲▼ to select [SCHEDULE].
- 2) Press ◀▶ to select [ON], and press the <ENTER> button.
 - The [SCHEDULE] screen is displayed.
- 3) Press ▲▼ to select [PROGRAM EDIT].
- 4) Press ◀▶ to select a program number, and press the <ENTER> button.
- 5) Press ▲▼ to select a command number, and press the <ENTER> button.
 - You can change the page using ◀▶.
- 6) Press ▲▼ to select [TIME], and press the <ENTER> button.
 - The projector is in the adjustment mode (the time is blinking).
- 7) Press ◀▶ to select “hour” or “minute”, and press ▲▼ or the number (<0> - <9>) buttons to set a time, and then press the <ENTER> button.
- 8) Press ▲▼ to select [COMMAND].
- 9) Press the <ENTER> button.
 - The [COMMAND] detailed screen is displayed.

10) Press ▲▼ to select a [COMMAND].

- For [COMMAND] which requires detailed settings, the items of the detailed settings will switch each time you press ◀▶.
- When [INPUT] is selected, press the <ENTER> button, and then press ▲▼◀▶ to select the input to be set.

[COMMAND]	Detailed settings of [COMMAND]	Description
[POWER ON]	—	Switches on the projector.
[STANDBY]	—	Enters standby.
[QUICK STARTUP]	[ON]	Enables the function of the [PROJECTOR SETUP] menu → [ECO MANAGEMENT] → [QUICK STARTUP].
	[OFF]	Disables the function of the [PROJECTOR SETUP] menu → [ECO MANAGEMENT] → [QUICK STARTUP].
[SHUTTER]	[OPEN]	Disables the shutter function (shutter: open).
	[CLOSE]	Enables the shutter function (shutter: closed).
[INPUT]	[COMPUTER]	Switches the input to COMPUTER.
	[HDMI1]	Switches the input to HDMI1.
	[HDMI2]	Switches the input to HDMI2.
	[HDMI3]	Switches the input to HDMI3.
	[DIGITAL LINK]	Switches the input to DIGITAL LINK.
	[INPUT1] - [INPUT10]*1	Switches the input to DIGITAL LINK, and switches the input of the DIGITAL LINK output supported device to the specified input.
[LIGHT POWER]	[NORMAL]	Prioritizes luminance.
	[ECO]	Controls the power to increase the life of the light source although the luminance is lower than that of [NORMAL].
	[QUIET]	Prioritizes the operation with less noise although the luminance is lower than that of [NORMAL].
	[USER]	Controls the power according to settings in [USER].
[IN STANDBY MODE(AUDIO)]	[OFF]	Stops the audio output during standby.
	[ON]	Outputs the audio during standby.
[VOLUME]	[0] - [63]	Sets the volume.

*1 When the optional DIGITAL LINK output supported device (Model No.: ET-YFB100G, ET-YFB200G) is connected to the projector, its input name is automatically reflected from [INPUT1] to [INPUT10]. When an item that does not reflect the input name is selected, it will be disabled.

11) Press the <ENTER> button.

- The command is fixed and ● is displayed at the left of the selected command.
- After the command is fixed, press the <MENU> button to close the detailed setting screen.

12) Press ▲▼◀▶ to select [STORE], and press the <ENTER> button.

Note

- To delete a command that has been already set, press the <DEFAULT> button on the remote control while the screen in Step 5) is displayed, or select [DELETE] at the screen in Step 6) and press the <ENTER> button.
- If multiple commands have been set for the same time, they are executed in chronological order starting from the smallest command number.
- The operating time will be the local time. (➔ page 114)
- If an operation is executed with the remote control or control panel of the projector or with a control command before the command set in [SCHEDULE] is executed, the command set with the schedule function may not be executed.

[MULTI PROJECTOR SYNC]

Set the contrast synchronization function and the shutter synchronization function.

The contrast synchronization function is a function to display a combined screen with a balanced contrast by sharing the brightness level of the video signal input to each projector when a multi-display is constructed by combining the projected image of multiple projectors. The shutter synchronization function is a function to synchronize the shutter operation of the specified projector to other projectors, and the effect using the shutter function including the fade out/fade in operation can be synchronized.

To use the contrast synchronization function and the shutter synchronization function, it is necessary to connect the projectors targeted for synchronization in a loop with daisy chain connection using the <SERIAL/MULTI SYNC IN> terminal and the <MULTI SYNC OUT> terminal. For details of how to connect the projectors, refer to “Connecting example when using the contrast synchronization function/shutter synchronization function” (➔ page 49).

Note

- The contrast synchronization function and the shutter synchronization function can be used simultaneously.

Setting the contrast synchronization function

- 1) Press ▲▼ to select [MULTI PROJECTOR SYNC].
- 2) Press the <ENTER> button.
 - The [MULTI PROJECTOR SYNC] screen is displayed.
- 3) Press ▲▼ to select [MODE].
- 4) Press ◀▶ to switch the item.
 - The items will switch each time you press the button.

[OFF]	Select this item when the contrast synchronization function and the shutter synchronization function are not used.
[MAIN]	Select this item when the contrast synchronization function or the shutter synchronization function is used. Set this item only on one projector out of the projectors that are linked. The projector set as the [MAIN] will calculate the brightness level of the video signal to become optimum on the whole combined screen for each frame. All the projectors targeted for contrast synchronization will control the dynamic contrast function based on the calculation result.
[SUB]	Select this item when the contrast synchronization function or the shutter synchronization function is used. Set this item in all the linked projectors excluding the projector set as the [MAIN].

- When anything other than [OFF] is selected, the diagnostic result is displayed in [LINK STATUS], indicating if all the projectors including the projectors targeted for synchronization are correctly connected, and if [MODE] is correctly set.

[LINKED]	All the projectors are correctly connected, and correctly set. They are in the condition that the contrast synchronization function or the shutter synchronization function can be used.
[NO LINK]	The projectors are not correctly connected, or not correctly set. Check the cable connection status and the projector setting for each projector that is linked.

- 5) Press ▲▼ to select [CONTRAST SYNC].
- 6) Press ◀▶ to switch the item.
 - The items will switch each time you press the button.

[OFF]	Select this item when the contrast synchronization function is not used.
[ON]	Select this item when the contrast synchronization function is used.

Note

- The contrast synchronization function will operate when all of the following conditions are fulfilled.
 - All the projectors to be linked are connected in a loop with the daisy chain connection. (Maximum 64 projectors)
 - [MODE] on only one projector that is linked is set to [MAIN], and [MODE] on all other projectors are set to [SUB].
 - [CONTRAST SYNC] on the projectors to perform the contrast synchronization is set to [ON].
- It is possible to set [CONTRAST SYNC] to [OFF] for the projectors that are linked but not to synchronize.

Setting the shutter synchronization function

- 1) Press ▲▼ to select [MULTI PROJECTOR SYNC].
- 2) Press the <ENTER> button.
 - The [MULTI PROJECTOR SYNC] screen is displayed.
- 3) Press ▲▼ to select [MODE].

4) Press ◀▶ to switch the item.

- The items will switch each time you press the button.

[OFF]	Select this item when the contrast synchronization function and the shutter synchronization function are not used.
[MAIN]	Select this item when the contrast synchronization function or the shutter synchronization function is used. Set this item only on one projector that becomes the synchronization source of the shutter operation.
[SUB]	Select this item when the contrast synchronization function or the shutter synchronization function is used. Set this item in all the linked projectors excluding the projector set as the [MAIN].

- When anything other than [OFF] is selected, the diagnostic result is displayed in [LINK STATUS], indicating if all the projectors including the projectors targeted for synchronization are correctly connected, and if [MODE] is correctly set.

[LINKED]	All the projectors are correctly connected, and correctly set. They are in the condition that the contrast synchronization function or the shutter synchronization function can be used.
[NO LINK]	The projectors are not correctly connected, or not correctly set. Check the cable connection status and the projector setting for each projector that is linked.

5) Press ▲▼ to select [SHUTTER SYNC].

6) Press ◀▶ to switch the item.

- The items will switch each time you press the button.

[OFF]	Select this item when the shutter synchronization function is not used.
[ON]	Select this item when the shutter synchronization function is used.

Note

- The shutter synchronization function will operate when all of the following conditions are fulfilled.
 - All the projectors to be linked are connected in a loop with the daisy chain connection. (Maximum 64 projectors)
 - [MODE] on only one projector that is linked is set to [MAIN], and [MODE] on all other projectors are set to [SUB].
 - [SHUTTER SYNC] on the projectors to perform the shutter synchronization is set to [ON].
- It is possible to set [SHUTTER SYNC] to [OFF] for the projectors that are linked but not to synchronize.
- The shutter operation by the shutter synchronization function will follow the setting of the [DISPLAY OPTION] menu → [SHUTTER SETTING] on the projector that [MODE] is set to [MAIN].
- When the input signal to each linked projector is not synchronized, the timing of the shutter operation between the projectors may shift up to 1 frame while using the shutter synchronization function.
- The shutter function of the projector with [MODE] set to [SUB] can be operated individually. At that time, the shutter operation will follow the setting of the [DISPLAY OPTION] menu → [SHUTTER SETTING] set in that projector.

[RS-232C]

Set the communication condition of the <SERIAL/MULTI SYNC IN> terminal. Refer to “<SERIAL/MULTI SYNC IN> / <MULTI SYNC OUT> terminals” (➡ page 194).

1) Press ▲▼ to select [RS-232C].

2) Press the <ENTER> button.

- The [RS-232C] screen is displayed.

3) Press ▲▼ to select [INPUT SELECT].

4) Press ◀▶ to switch the item.

[PROJECTOR]	Performs the RS-232C communication with the <SERIAL/MULTI SYNC IN> terminal of the projector.
[DIGITAL LINK]	Performs the RS-232C communication via the optional DIGITAL LINK output supported device (Model No.: ET-YFB100G, ET-YFB200G) and the <DIGITAL LINK/LAN> terminal.

5) Press ▲▼ to select [BAUDRATE].

6) Press ◀▶ to switch the item.

- The items will switch each time you press the button.

[9600]	Select the proper speed.
[19200]	
[38400]	

- 7) Press ▲▼ to select [PARITY].
- 8) Press ◀▶ to switch the item.
 - The items will switch each time you press the button.

[NONE]	Select the parity condition.
[EVEN]	
[ODD]	

Note

- When [INPUT SELECT] is set to [DIGITAL LINK], communication using that serial terminal is available only when the corresponding device (such as the optional DIGITAL LINK output supported device (Model No.: ET-YFB100G, ET-YFB200G)) is connected to the <DIGITAL LINK/LAN> terminal.
- When transferring logos via the optional DIGITAL LINK output supported device (Model No.: ET-YFB100G, ET-YFB200G), setting for “NO SIGNAL SLEEP” of the DIGITAL LINK output supported device should be set to “OFF” to avoid interruption of communication.
- When [INPUT SELECT] is set to [DIGITAL LINK], communication speed for input is fixed to 9 600 bps and the parity is fixed to “NONE”.

Using the control command for the existing projector

Set this function when using the control command for previously purchased Panasonic projector to control this projector with a computer using the <SERIAL/MULTI SYNC IN> terminal on the projector. The existing Panasonic projector control software, etc., can continually be used.

- 1) Press ▲▼ to select [RS-232C].
- 2) Press the <ENTER> button.
 - The [RS-232C] screen is displayed.
- 3) Press ▲▼ to select [EMULATE].
- 4) Press the <ENTER> button.
 - The [EMULATE] screen is displayed.
- 5) Press ▲▼ to select an item.

[OFF]	Does not use existing control command for the projector.
[D3500]	D3500 series
[D4000]	D4000 series
[D/W5k SERIES]	D5700 series, DW5100 series, D5600 series, DW5000 series, D5500 series
[D/W/Z6k SERIES]	DZ870 series, DW830 series, DX100 series, DZ780 series, DW750 series, DX820 series, DZ770 series, DW740 series, DX810 series, DZ680 series, DW640 series, DX610 series, DW730 series, DX800 series, DZ6710 series, DZ6700 series, DW6300 series, D6000 series, D5000 series, DZ570 series, DW530 series, DX500 series, RZ970 series, RW930 series, RX110 series, RZ770 series, RZ660 series, RW730 series, RW620 series, RZ670 series, RW630 series, RZ575 series, RZ570 series
[L730 SERIES]	L730 series, L720 series, L520 series
[L780 SERIES]	L780 series, L750 series
[L735 SERIES]	L735 series
[L785 SERIES]	L785 series
[F/W SERIES]	FW430 series, FX400 series, FW300 series, F300 series, F200 series, FW100 series, F100 series
[LZ370]	LZ370 series
[LB/W SERIES]	LB3 series, LB2 series, LB1 series, ST10 series, LB90 series, LW80NT series, LB80 series, LB78 series, LB75 series
[VX500 SERIES]	VW435N series, VW440 series, VW430 series, VX505N series, VX510 series, VX500 series, VW330 series, VX400NT series, VX400 series, VX41 series
[EZ570 SERIES]	EZ570 series, EW630 series, EW530 series, EX600 series, EX500 series
[VW431D]	VW431D series

- 6) Press the <ENTER> button.
 - The confirmation screen is displayed.
- 7) Press ◀▶ to select [OK], and press the <ENTER> button.

[REMOTE2 MODE]

Set the <REMOTE 2 IN> terminal.

- 1) Press ▲▼ to select [REMOTE2 MODE].
- 2) Press ◀▶ to switch the item.
 - The items will switch each time you press the button.

[DEFAULT]	Uses pin assignment of the <REMOTE 2 IN> terminal in standard setting.
[USER]	Use this item when changing the setting of the <REMOTE 2 IN> terminal. (➔ page 198)
[F/W SERIES]	Uses the <REMOTE 2 IN> terminal setting compatible with the F/W series.

- Proceed to Step 3) when [USER] is selected.

- 3) Press the <ENTER> button.
- 4) Press ▲▼ to select one from [PIN2] to [PIN8], and press ◀▶ to switch the setting.

[FUNCTION BUTTON]

Set the function of the <FUNCTION> button on the remote control.

- 1) Press ▲▼ to select [FUNCTION BUTTON].
- 2) Press the <ENTER> button.
 - The [FUNCTION BUTTON] screen is displayed.
- 3) Press ▲▼ to select a function.

[DISABLE]	Disables the <FUNCTION> button.
[SUB MEMORY]	Displays the sub memory list. (➔ page 132)
[SYSTEM SELECTOR]	Switches the [SYSTEM SELECTOR] setting. (➔ page 83)
[DAYLIGHT VIEW]	Switches the [DAYLIGHT VIEW] setting. (➔ page 82)

- 4) Press the <ENTER> button.

[LENS]

Perform the setting and operation regarding the projection lens.

[LENS TYPE]

When the projector is used for the first time or when the projection lens is replaced, confirm the [LENS TYPE] setting. Change the setting if the type does not match the projection lens attached to the projector.

- 1) Press ▲▼ to select [LENS], and press the <ENTER> button.
 - The [LENS] screen is displayed.
- 2) Press ▲▼ to select [LENS TYPE], and press the <ENTER> button.
 - The [LENS TYPE] screen is displayed.
- 3) Press ▲▼ to select the lens type.

[ET-ELS20]*1	Select this item when the standard zoom lens or the Zoom Lens (Model No.: ET-ELS20) is attached to the projector.
[ET-ELW21]	Select this item when the Fixed-focus Lens (Model No.: ET-ELW21) is attached to the projector.
[ET-ELW22]	Select this item when the Zoom Lens (Model No.: ET-ELW22) is attached to the projector.
[ET-ELW20]	Select this item when the Zoom Lens (Model No.: ET-ELW20) is attached to the projector.
[ET-ELT22]	Select this item when the Zoom Lens (Model No.: ET-ELT22) is attached to the projector.
[ET-ELT23]	Select this item when the Zoom Lens (Model No.: ET-ELT23) is attached to the projector.

*1 This product is equivalent to the standard zoom lens.

- 4) Press the <ENTER> button.
 - The [LENS CALIBRATION] screen is displayed.

5) Press ◀▶ to select [OK], and press the <ENTER> button.

- The lens calibration is started.
- After completing the calibration, the projection lens will move to the home position.
- To cancel, select [CANCEL]. In this case, the [LENS TYPE] setting is not changed.

Note

- The lens shift range varies depending on the lens type. If [LENS TYPE] is set incorrectly, lens shift range may not be adjusted properly. For details, see "Lens shift range" (▶ page 65).

[LENS CALIBRATION]

Detect the lens shift adjustment limit value, and perform the calibration in the adjustment range.

1) Press ▲▼ to select [LENS].

2) Press the <ENTER> button.

- The [LENS] screen is displayed.

3) Press ▲▼ to select [LENS CALIBRATION].

4) Press the <ENTER> button.

- The confirmation screen is displayed.

5) Press ◀▶ to select [OK], and press the <ENTER> button.

- The lens calibration is started.
- After completing the calibration, the projection lens will move to the home position.
- To cancel, select [CANCEL].

Note

- [PROGRESS] is displayed in the menu during lens calibration. The operation cannot be canceled during calibration.
- [INCOMPLETE] is displayed when the lens calibration was not executed correctly.
- The lens shift range varies depending on the lens type. If [LENS TYPE] is set incorrectly, lens shift range may not be adjusted properly. For details, see "Lens shift range" (▶ page 65).
- Pressing the <FOCUS> button on the remote control for three seconds or longer will also display the confirmation screen for lens calibration execution.

[AUDIO SETTING]

Set audio functions in detail.

Adjusting the volume

1) Press ▲▼ to select [AUDIO SETTING].

2) Press the <ENTER> button.

- The [AUDIO SETTING] screen is displayed.

3) Press ▲▼ to select [VOLUME].

4) Press ◀▶ to adjust the level.

Operation	Adjustment	Range of adjustment
Press ▶.	Increases the volume.	0 - 63
Press ◀.	Decreases the volume.	

Adjusting the left to right audio balance

1) Press ▲▼ to select [AUDIO SETTING].

2) Press the <ENTER> button.

- The [AUDIO SETTING] screen is displayed.

3) Press ▲▼ to select [BALANCE].

4) Press ◀▶ to adjust the level.

Operation	Adjustment	Range of adjustment
Press ►.	Increases the volume on the right.	L16 - R16
Press ◀.	Increases the volume on the left.	

Setting audio output in the standby mode

- 1) Press ▲▼ to select [AUDIO SETTING].
- 2) Press the <ENTER> button.
 - The [AUDIO SETTING] screen is displayed.
- 3) Press ▲▼ to select [IN STANDBY MODE].
- 4) Press ◀▶ to switch the item.
 - The items will switch each time you press the button.

[OFF]	Audio is not output during standby.
[ON]	Audio is output during standby.

Note

- Audio is not output in the standby mode when the [PROJECTOR SETUP] menu → [ECO MANAGEMENT] → [STANDBY MODE] is set to [ECO].

Setting audio output while using the shutter function

- 1) Press ▲▼ to select [AUDIO SETTING].
- 2) Press the <ENTER> button.
 - The [AUDIO SETTING] screen is displayed.
- 3) Press ▲▼ to select [IN SHUTTER].
- 4) Press ◀▶ to switch the item.
 - The items will switch each time you press the button.

[OFF]	Audio is not output while using the shutter function (shutter: closed).
[ON]	Audio is output while using the shutter function (shutter: closed).

Setting mute mode

- 1) Press ▲▼ to select [AUDIO SETTING].
- 2) Press the <ENTER> button.
 - The [AUDIO SETTING] screen is displayed.
- 3) Press ▲▼ to select [MUTE].
- 4) Press ◀▶ to switch the item.
 - The items will switch each time you press the button.

[OFF]	Audio is output.
[ON]	Audio is not output.

Setting audio input from a connected device

- 1) Press ▲▼ to select [AUDIO SETTING].
- 2) Press the <ENTER> button.
 - The [AUDIO SETTING] screen is displayed.

3) Press ▲▼ to select item to set in [AUDIO IN SELECT].

[COMPUTER]	Sets the audio to output when COMPUTER is input.
[HDMI1]	Sets the audio to output when HDMI1 is input.
[HDMI2]	Sets the audio to output when HDMI2 is input.
[HDMI3]	Sets the audio to output when HDMI3 is input.
[DIGITAL LINK]	Sets the audio to output when DIGITAL LINK is input.

4) Press ◀▶ to switch the item.

- The items will switch each time you press the button.
- The item is fixed to [AUDIO IN] when [COMPUTER] is selected.

[AUDIO IN]	Audio connected to the <AUDIO IN> terminal is output during projection of image from the set input terminal.
[HDMI1 AUDIO IN]*1	Audio input to HDMI1 is output.
[HDMI2 AUDIO IN]*2	Audio input to HDMI2 is output.
[HDMI3 AUDIO IN]*3	Audio input to HDMI3 is output.
[DIGITAL LINK AUDIO IN]*4	Audio input to DIGITAL LINK is output.

*1 Only when the input signal is HDMI1

*2 Only when the input signal is HDMI2

*3 Only when the input signal is HDMI3

*4 Only when the input signal is DIGITAL LINK

[FILTER COUNTER]

Check the runtime of the filter and set the cleaning/replacement cycle of the filter. Also, the runtime of the filter can be reset.

1) Press ▲▼ to select [FILTER COUNTER].

2) Press the <ENTER> button.

- The [FILTER COUNTER] screen is displayed.

[FILTER COUNTER]	Displays the runtime of the filter.
[TIMER]	Sets the cleaning/replacement cycle of the filter.
[FILTER COUNTER RESET]	Resets the runtime of the filter.

Setting [TIMER]

If the filter is to be cleaned/replaced periodically, set the cycle in hours. Once the runtime of the filter reaches the set time, a message prompting to clean/replace the filter [FILTER COUNTER has reached the set time.] is displayed on the projected image.

1) Press ▲▼ to select [FILTER COUNTER].

2) Press the <ENTER> button.

- The [FILTER COUNTER] screen is displayed.

3) Press ▲▼ to select [TIMER].

4) Press ◀▶ to switch the item.

- The items will switch each time you press the button.

[OFF]	Select this item when a message is not to be displayed.
[1000 H] - [20000 H]	Select this item when a message is to be displayed. The cleaning/replacement cycle of the filter can be set in 1 000 hour intervals.

Resetting [FILTER COUNTER]

Reset the runtime of the filter.

1) Press ▲▼ to select [FILTER COUNTER].

- 2) Press the <ENTER> button.
 - The [FILTER COUNTER] screen is displayed.
- 3) Press ▲▼ to select [FILTER COUNTER RESET].
- 4) Press the <ENTER> button.
- 5) The confirmation screen is displayed, so press ◀▶ to select [OK], and press the <ENTER> button.
 - Display of [FILTER COUNTER] will change to [0 H].

[DC OUT]

Set the power supply function of the <DC OUT> terminal.

- 1) Press ▲▼ to select [DC OUT].
- 2) Press ◀▶ to select an item.

[ON]	Enables the power supply function. Power is supplied to the external device connected to the <DC OUT> terminal.
[OFF]	Disables the power supply function. The power is not supplied even if an external device is connected to the <DC OUT> terminal.

Note

- When [DC OUT] is set to [ON], the power is supplied even in the standby state or ready state in the following cases.
 - When the [PROJECTOR SETUP] menu → [ECO MANAGEMENT] → [STANDBY MODE] is set to [NORMAL], and then the projector goes into the standby state by pressing the power <⏻/|> button
 - When the [PROJECTOR SETUP] menu → [ECO MANAGEMENT] → [POWER MANAGEMENT] is set to [READY], and no signal is detected and the projector goes into the ready state
- When an external device exceeding the rating (DC 5 V, maximum 2 A) is connected to the <DC OUT> terminal while this function is set to [ON], an error is detected and the power supply will be stopped. At this time, [ERROR] is displayed in [DC OUT]. When [ERROR] is displayed, disconnect the external device, switch off the projector, and then switch on the projector.

[STATUS]

Display the status of the projector.

- 1) Press ▲▼ to select [STATUS].
- 2) Press the <ENTER> button.
 - The [STATUS] screen is displayed.
- 3) Press ◀▶ to switch the pages.
 - The page will change each time you press the button.

[PROJECTOR TYPE]	Displays the type of the projector.	
[SERIAL NUMBER]	Displays the serial number of the projector.	
[PROJECTOR RUNTIME]	Displays the runtime of the projector.	
[LIGHT RUNTIME]	Displays the runtime of the light source.	
[CONTINUOUS LIGHTING TIME]	Displays the elapsed time from when the light source is illuminated. The elapsed time after the illumination of the light source can be confirmed when adjusting the focus. The elapsed time is reset when the light source is temporarily turned off such as using the shutter function.	
[MAIN/SUB VERSION]	Displays the main and sub versions of the firmware of the projector.	
[INTAKE AIR TEMP.] ^{*1}	Displays the status of the intake air temperature of the projector.	
[EXHAUST AIR TEMP.] ^{*1}	Displays the status of the exhaust air temperature of the projector.	
[LIGHT TEMP. 1] ^{*1}	Displays the temperature status for the front block of the light source (on the lens side).	
[LIGHT TEMP. 2] ^{*1*2}	Displays the temperature status for the rear block of the light source (on the exhaust vent side).	
[SELF TEST]	Displays the status of the projector.	
[INPUT]	Displays the input terminal currently selected.	
[SIGNAL NAME]	Displays the input signal name.	
[MEMORY NO.]	Displays the memory number of the input signal.	
[ON COUNT]	[POWER ON TIMES]	Displays the number of times the power is turned on.

[NUMBER OF REGISTERED SIGNAL]	Displays the number of registered signals.	
[COOLING CONDITION]	Displays the set cooling conditions.	
[ATMOSPHERIC PRESSURE]	Displays the atmospheric pressure.	
[REMOTE2 STATUS]	Displays the control status of the REMOTE2.	
[EMULATE]	Displays the setting in the [PROJECTOR SETUP] menu → [RS-232C] → [EMULATE].	
[SIGNAL INFORMATION]	[INPUT]	Displays the input terminal used for the projected image.
	[SIGNAL FORMAT]	Displays the format of the input signal.
	[SIGNAL FREQUENCY]	Displays the frequency of the input signal.
	[SYNC.STATE]	Displays the sync polarity of the input signal.
	[V.SYNC WIDTH]	Displays the vertical sync signal pulse width of the input signal.
	[SCAN TYPE]	Displays the scan type of the input signal.
	[TOTAL DOTS]	Displays the total dot count of the input signal.
	[DISPLAY DOTS]	Displays the number of input signal display dots.
	[TOTAL LINES]	Displays the total line count of the input signal.
	[DISPLAY LINES]	Displays the number of input signal display lines.
	[SAMPLING]	Displays the sampling information of the input signal.
[SIGNAL LEVEL]	Displays the signal level of the input signal.	

*1 The temperature status is indicated with text color (green/yellow/red) and bar scale. Use the projector within the range that the indication is green.

*2 Only for PT-MZ880 and PT-MZ780.

Note

- E-mail containing the status can be sent to the E-mail address (up to two addresses) set in “[E-mail set up] page” (➔ page 158) by pressing the <ENTER> button while the [STATUS] screen is displayed.
- There may be items that are displayed and items that are not displayed in [SIGNAL INFORMATION] depending on the setting or the input signal.
- If any abnormality has occurred on the projector, press the <DEFAULT> button while the [STATUS] screen is displayed to display the detail screen of the error information.
- For details on the contents displayed in [SELF TEST], refer to “[SELF TEST] display” (➔ page 183).

[DATA CLONING]

Perform the operations of the data cloning function. Data such as the settings and adjustment values of the projector can be copied to multiple projectors via LAN.

For details of operation, refer to “Using the data cloning function” (➔ page 165).

[SAVE ALL USER DATA]

Save the various setting values as a backup in the built-in memory of the projector.

- 1) Press ▲▼ to select [SAVE ALL USER DATA].
- 2) Press the <ENTER> button.
 - The [SECURITY PASSWORD] screen is displayed.
- 3) Enter a security password and press the <ENTER> button.
- 4) When the confirmation screen is displayed, press ◀▶ to select [OK], and press the <ENTER> button.
 - [PROGRESS] is displayed while saving data.

Note

- The security password is the password set in the [SECURITY] menu → [SECURITY PASSWORD CHANGE].
Initial password as the factory default: ▲▶▼◀▲▶▼◀
- Data set from the computer application is not included in [ALL USER DATA].

[LOAD ALL USER DATA]

Load the various setting values saved as a backup in the built-in memory of the projector.

- 1) Press ▲▼ to select [LOAD ALL USER DATA].

- 2) Press the <ENTER> button.
 - The [SECURITY PASSWORD] screen is displayed.
- 3) Enter a security password and press the <ENTER> button.
- 4) When the confirmation screen is displayed, press ◀▶ to select [OK], and press the <ENTER> button.

Note

- The security password is the password set in the [SECURITY] menu → [SECURITY PASSWORD CHANGE].
Initial password as the factory default: ▲▶▼◀▲▶▼◀
- The projector enters the standby mode to reflect the setting values when [LOAD ALL USER DATA] is executed.
- Data registered from a computer is not included in [ALL USER DATA].

[HDMI CEC]

Sets the CEC (Consumer Electronics Control) function of HDMI.

CEC is a function that is realized by exchanging device control signals with external devices connected with an HDMI cable. Using the remote control of the projector, it is possible to operate the CEC-compatible external device (hereinafter referred to as "CEC-compatible device") and to control the power on/off link status between the projector and the CEC-compatible device.

For details on how to use the CEC function, refer to "Using HDMI-CEC function" (➡ page 167).

- 1) Press ▲▼ to select [HDMI CEC].
- 2) Press ◀▶ to switch the item.
 - The items will switch each time you press the button.

[ON]	Enables the CEC function.
[OFF]	Disables the CEC function.

Operating a CEC-compatible device

Operate the CEC-compatible device connected to the <HDMI IN 1> terminal, <HDMI IN 2> terminal or <HDMI IN 3> terminal.

[HDMI-CEC OPERATION] can be operated when HDMI1 input, HDMI2 input or HDMI3 input is selected. Switch to the input that is corresponding to the CEC-compatible device you want to operate in advance.

- 1) Press ▲▼ to select [HDMI CEC].
- 2) Press ◀▶ to select [ON].
- 3) Press the <ENTER> button.
 - The [HDMI CEC] screen is displayed.
- 4) Press ▲▼ to select [HDMI 1], [HDMI 2] or [HDMI 3].
 - Select the input corresponding to the CEC-compatible device you want to operate.
 - Proceed to Step 6) when the device to operate is displayed.
- 5) Press ◀▶ to switch the item.
 - The devices will switch when multiple CEC-compatible devices are connected to one input.
 - Select the device to operate.
- 6) Press ▲▼ to select [HDMI-CEC OPERATION].
- 7) Press the <ENTER> button.
 - The HDMI-CEC operation screen is displayed.
- 8) Select the item displayed on the HDMI-CEC operation screen to operate the device.
 - Refer to the "Using HDMI-CEC function" (➡ page 167) for the operation details.

Note

- If no CEC-compatible device is connected to <HDMI IN 1>, <HDMI IN 2> or <HDMI IN 3> terminal, there is no device displayed at [HDMI 1], [HDMI 2] or [HDMI 3] and [----] is displayed.
- To exit the HDMI-CEC operation screen, press the <RETURN> button or <MENU> button.

Changing the menu code

The menu code that calls up the operation menu of the CEC-compatible device varies depending on the device manufacturer. If you cannot call up the operation menu of a CEC-compatible device from the HDMI-CEC operation screen, change the menu code setting.

- 1) Press ▲▼ to select [HDMI CEC].
- 2) Press ◀▶ to select [ON].
- 3) Press the <ENTER> button.
 - The [HDMI CEC] screen is displayed.
- 4) Press ▲▼ to select [MENU CODE].
- 5) Press ◀▶ to switch the item.
 - The items will switch each time you press the button.
 - Select the menu code from [1] to [6].

Setting the link control

Make settings for the link control between the projector and CEC-compatible devices.

[PROJECTOR -> DEVICE]

Set the link control from the projector to the CEC-compatible device.

- 1) Press ▲▼ to select [HDMI CEC].
- 2) Press ◀▶ to select [ON].
- 3) Press the <ENTER> button.
 - The [HDMI CEC] screen is displayed.
- 4) Press ▲▼ to select [PROJECTOR -> DEVICE].
- 5) Press ◀▶ to switch the item.
 - The items will switch each time you press the button.

[DISABLE]	Disables the power link control from the projector to the CEC-compatible device. Select this when you do not want the power status of the CEC-compatible device to link with the power status of the projector.
[POWER OFF]	Enables power-off link control. When you turn off the power of the projector and put it in standby mode, all CEC-compatible devices connected to the <HDMI IN 1> terminal, <HDMI IN 2> terminal or <HDMI IN 3> terminal will enter standby mode. Power-on link control is disabled.
[POWER ON/OFF]	Enables power-on link control and power-off link control. If you turn on the projector and start projection with the HDMI1 input, HDMI2 input or HDMI3 input selected, the CEC-compatible device connected to the selected input will turn on. When you turn off the projector and put it in standby mode, all CEC-compatible devices connected to the <HDMI IN 1> terminal, <HDMI IN 2> terminal or <HDMI IN 3> terminal will enter standby mode.

[DEVICE -> PROJECTOR]

Set the link control from the CEC-compatible device to the projector.

- 1) Press ▲▼ to select [HDMI CEC].
- 2) Press ◀▶ to select [ON].
- 3) Press the <ENTER> button.
 - The [HDMI CEC] screen is displayed.
- 4) Press ▲▼ to select [DEVICE -> PROJECTOR].
- 5) Press ◀▶ to switch the item.
 - The items will switch each time you press the button.

[TEST PATTERN] menu

On the menu screen, select [TEST PATTERN] from the main menu.

Refer to “Navigating through the menu” (➔ page 74) for the operation of the menu screen.

[TEST PATTERN]

Display the test pattern built-in to the projector.

Settings of position, size, and other factors will not be reflected in test patterns. Make sure to display the input signal before performing various adjustments.

1) Press ◀▶ to switch the [TEST PATTERN] item.

- The items will switch each time you press the button.

Menu screen + Color bar (vertical)	Displays a test pattern with the menu screen. Select a desired test pattern.
Menu screen + Color bar (horizontal)	
Menu screen + 16 tones (vertical 1)	
Menu screen + 16 tones (vertical 2)	
Menu screen + 16 tones (horizontal 1)	
Menu screen + 16 tones (horizontal 2)	
Menu screen + Focus	
Menu screen + 16:9/4:3 aspect frame	
Menu screen + All white	
Menu screen + All black	
Menu screen + Input screen	Displays the menu screen and input signal. Internal test patterns are not displayed.

Note

- Press the <ON SCREEN> button on the remote control while the test pattern is displayed to hide the menu screen.

[SIGNAL LIST] menu

On the menu screen, select [SIGNAL LIST] from the main menu.

Refer to “Navigating through the menu” (➔ page 74) for the operation of the menu screen.

■ Registered signal details

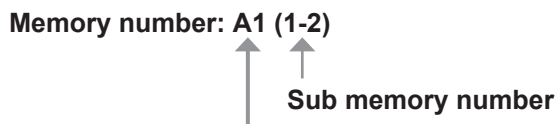

When the address number (A1, A2, ... L7, L8) signal is registered

- A name can be set for each sub memory (➔ page 132).

Registering new signals

After a new signal is input and the <MENU> button on the remote control or the control panel is pressed, the registration is completed and the [MAIN MENU] screen is displayed.

Note

- Up to 96 signals, including sub memories, can be registered to the projector.
- There are 12 pages (eight memories of A through L, with eight memories possible on each page) for memory numbers, and the signal is registered to the lowest number that is available. If there is no available memory number it will be overwritten from the oldest signal.
- The name to be registered is automatically determined by the input signal.
- If a menu is being displayed, the new signals will be registered at the instant they are input.

Renaming the registered signal

Registered signals can be renamed.

- 1) Press ▲▼◀▶ to select the signal of which name is to be changed.
- 2) Press the <ENTER> button.
 - The [REGISTERED SIGNAL STATUS] screen is displayed.
 - The memory number, input terminal, input signal name, frequency, synch polarity, etc., are displayed.
 - Press the <MENU> button to return to the [REGISTERED SIGNAL LIST] screen.
- 3) Press the <ENTER> button.
 - The [REGISTERED SIGNAL SETUP] screen is displayed.
- 4) Press ▲▼ to select [SIGNAL NAME CHANGE].
- 5) Press the <ENTER> button.
 - The [SIGNAL NAME CHANGE] screen is displayed.
- 6) Press ▲▼◀▶ to select the text, and press the <ENTER> button to enter the text.
- 7) After the name is changed, press ▲▼◀▶ to select [OK], and press the <ENTER> button.
 - The registration is completed and the [REGISTERED SIGNAL SETUP] screen returns.
 - When pressing ▲▼◀▶ to select [CANCEL] and pressing the <ENTER> button, the changed signal name will not be registered and an automatically registered signal name will be used.

Deleting the registered signal

Registered signals can be deleted.

- 1) Press ▲▼◀▶ to select the signal to delete.
- 2) Press the <DEFAULT> button on the remote control.
 - The [REGISTERED SIGNAL DELETE] screen is displayed.
 - To cancel the deletion, press the <MENU> button to return to the [REGISTERED SIGNAL LIST] screen.
- 3) Press the <ENTER> button.
 - The selected signal will be deleted.

Note

- A registered signal can also be deleted from [REGISTERED SIGNAL DELETE] on the [REGISTERED SIGNAL SETUP] screen.

Protecting the registered signal

- 1) Press **▲▼◀▶** to select the signal to protect.
- 2) Press the **<ENTER>** button.
 - The [REGISTERED SIGNAL STATUS] screen is displayed.
- 3) Press the **<ENTER>** button.
 - The [REGISTERED SIGNAL SETUP] screen is displayed.
- 4) Press **▲▼** to select [LOCK].
- 5) Press **◀▶** to switch the item.
 - The items will switch each time you press the button.

[OFF]	The signal is not protected.
[ON]	The signal is protected.

- A lock icon is displayed at the right of the [REGISTERED SIGNAL LIST] screen when [LOCK] is set to [ON].

**Note**

- When [LOCK] is set to [ON], signal deletion, image adjustment, and automatic setup are not available. To perform these operations, set [LOCK] to [OFF].
- A signal can be registered to the sub memory even if it is protected.
- Even a protected signal will be deleted if [INITIALIZE] is executed.

Expanding signal lock-in range

- 1) Press **▲▼◀▶** to select the signal to set.
- 2) Press the **<ENTER>** button.
 - The [REGISTERED SIGNAL STATUS] screen is displayed.
- 3) Press the **<ENTER>** button.
 - The [REGISTERED SIGNAL SETUP] screen is displayed.
- 4) Press **▲▼** to select [LOCK-IN RANGE].
- 5) Press **◀▶** to switch the item.
 - The items will switch each time you press the button.

[NARROW]	Select this item usually.
[WIDE]	Widens the lock-in range.

- An expansion icon is displayed at the right of the [REGISTERED SIGNAL LIST] screen when [LOCK-IN RANGE] is set to [WIDE].

**Note**

- Switch the range where the signal to be input is determined to be the same signal as the already registered signal.
- To prioritize the determination that a signal is the same as the already registered signal, set this function to [WIDE].
- Use in cases such as when the synchronizing frequency of a signal to be input has changed slightly, or multiple signal lists are registered.
- This function can be used only when a signal is input from the <COMPUTER IN> terminal, <HDMI IN 1> terminal, the <HDMI IN 2> terminal, the <HDMI IN 3> terminal, or the <DIGITAL LINK/LAN> terminal.
- When [WIDE] is set, the image may be distorted because a signal is recognized as the same even if its synchronizing frequency varies slightly.
- When a signal to be input corresponds to multiple signals set in [WIDE], a registered signal with a high memory number receives priority.

Example: a signal to be input that corresponds to memory numbers A2, A4 and B1 will be determined to be B1.

- When a registration signal is deleted, the settings are also deleted.
- In an environment where multiple types of signals are input to the same terminal, signals are sometimes not determined correctly when the setting is set to [WIDE].

Sub memory

The projector has a sub memory function that can register the multiple image adjustment data, even if it is recognized as the same signal by the frequency or format of the synchronization signal source.

Use this function when you need to switch the aspect or adjust the picture quality such as the white balance while using the same signal source. The sub memory includes all the data that can be adjusted for each signal, such as the image aspect ratio and data adjusted in the [PICTURE] menu (items such as [CONTRAST] and [BRIGHTNESS]).

Registering to the sub memory

- 1) **While in the normal screen (where no menu is displayed), press ▲▼.**
 - The sub memory registration screen is displayed if the sub memory is not registered. Proceed to Step 3).
 - A list of sub memories registered to the signal currently input is displayed.
 - The <FUNCTION> button on the remote control can be used instead of ▲▼ when [SUB MEMORY] is selected from the [PROJECTOR SETUP] menu → [FUNCTION BUTTON].
- 2) **Press ▲▼◀▶ to select the sub memory number to register in [SUB MEMORY LIST].**
- 3) **Press the <ENTER> button.**
 - The [SIGNAL NAME CHANGE] screen is displayed.
- 4) **Press ▲▼◀▶ to select [OK], and press the <ENTER> button.**
 - To rename the registered signal, follow the procedure in Steps 6) and 7) in “Renaming the registered signal” (➔ page 130).

Switching to the sub memory

- 1) **While in the normal screen (where no menu is displayed), press ▲▼.**
 - A list of sub memories registered to the signal currently input is displayed.
- 2) **Press ▲▼◀▶ to select the signal to switch in [SUB MEMORY LIST].**
- 3) **Press the <ENTER> button.**
 - This switches to the signal selected in Step 2).

Deleting the sub memory

- 1) **While in the normal screen (where no menu is displayed), press ▲▼.**
 - The [SUB MEMORY LIST] screen is displayed.
- 2) **Press ▲▼◀▶ to select the sub memory to be deleted, and press the <DEFAULT> button on the remote control.**
 - The [REGISTERED SIGNAL DELETE] screen is displayed.
 - To cancel the deletion, press the <MENU> button to return to the [SUB MEMORY LIST] screen.
- 3) **Press the <ENTER> button.**
 - The selected sub memory will be deleted.

[SECURITY] menu

On the menu screen, select [SECURITY] from the main menu, and select an item from the sub-menu. Refer to “Navigating through the menu” (➔ page 74) for the operation of the menu screen.

- When the projector is used for the first time
Initial password: Press ▲▶▼◀◀▶▶▼◀ in order, and press the <ENTER> button.

Attention

- When you select the [SECURITY] menu and press the <ENTER> button, entering a password is prompted. Enter the preset password and then continue operations of the [SECURITY] menu.
- When the password has been changed previously, enter the changed password, and press the <ENTER> button.

Note

- The entered password is displayed with * marks on the screen.
- An error message is displayed on the screen when the entered password is incorrect. Re-enter the correct password.

[SECURITY PASSWORD]

Display the [SECURITY PASSWORD] screen when the power is turned on with the <MAIN POWER> switch set to the <OFF> side. When the entered password is incorrect, the operation will be restricted to the power <⏻/> button.

- 1) Press ▲▼ to select [SECURITY PASSWORD].
- 2) Press ◀▶ to switch the item.
 - The items will switch each time you press the button.

[OFF]	Disables the security password entry.
[ON]	Enables the security password entry.

Note

- This item is set to [OFF] in the factory default setting or when the [PROJECTOR SETUP] menu → [INITIALIZE] → [ALL USER DATA] is executed. Set it to [ON] as necessary.
- Change the password periodically that is hard to guess.
- The security password is enabled after setting the item to [ON] and setting the <MAIN POWER> switch to <OFF>.

[SECURITY PASSWORD CHANGE]

Change the security password.

- 1) Press ▲▼ to select [SECURITY PASSWORD CHANGE].
- 2) Press the <ENTER> button.
 - The [SECURITY PASSWORD CHANGE] screen is displayed.
- 3) Press ▲▼◀▶ and the number (<0> - <9>) buttons to set the password.
 - Up to eight button operations can be set.
- 4) Press the <ENTER> button.
- 5) Re-enter the password for the confirmation.
- 6) Press the <ENTER> button.

Note

- The entered password is displayed with * marks on the screen.
- When numerical values are used for the security password, the security password is required to be initialized if the remote control is lost. Consult your dealer for the method of initialization.

[DISPLAY SETTING]

Overlap the security message (text or image) over the projecting image.

- 1) Press ▲▼ to select [DISPLAY SETTING].

2) Press ◀▶ to switch the item.

- The items will switch each time you press the button.

[OFF]	Hides the security message.
[TEXT]	Displays the text set in the [SECURITY] menu → [TEXT CHANGE].
[USER LOGO]	Displays the image registered by the user.

Note

- To create and register the [USER LOGO] image, use "Logo Transfer Software". The software can be downloaded from the website (<https://panasonic.net/cns/projector/>).

[TEXT CHANGE]

Edit the text to be displayed when [TEXT] is selected in [DISPLAY SETTING].

1) Press ▲▼ to select [TEXT CHANGE].

2) Press the <ENTER> button.

- The [TEXT CHANGE] screen is displayed.

3) Press ▲▼◀▶ to select the text, and press the <ENTER> button to enter the text.

4) Press ▲▼◀▶ to select [OK], and press the <ENTER> button.

- The text is changed.

[MENU LOCK]

Press the <MENU> button to display the menu, and set if menu operation is enabled or not.

1) Press ▲▼ to select [MENU LOCK].

2) Press ◀▶ to switch the item.

- The items will switch each time you press the button.

[OFF]	Enables the menu operation.
[ON]	Disables the menu operation.

Note

- This function is set to [OFF] as the factory default setting or after the [PROJECTOR SETUP] menu → [INITIALIZE] → [ALL USER DATA] is executed. Set it to [ON] as necessary.
- When [MENU LOCK] is set to [ON], the [MENU LOCK PASSWORD] screen is displayed by pressing the <MENU> button. Menu operation is enabled by entering the set menu lock password. In this case, enabling of the menu operation is maintained until the projector goes into the standby mode.

[MENU LOCK PASSWORD]

Change the menu lock password.

1) Press ▲▼ to select [MENU LOCK PASSWORD].

2) Press the <ENTER> button.

- The [MENU LOCK PASSWORD] screen is displayed.

3) Press ▲▼◀▶ to select the character, and press the <ENTER> button to enter the character.

- Up to 16 characters can be entered.

4) Press ▲▼◀▶ to select [OK], and press the <ENTER> button.

- To cancel, select [CANCEL].

Attention

- The initial password is AAAA as the factory default or after the [PROJECTOR SETUP] menu → [INITIALIZE] → [ALL USER DATA] is executed.
- Change the password periodically and make it hard to guess.
- To initialize your password, consult your distributor.

[CONTROL DEVICE SETUP]

Enable/disable the button operations on the control panel and the remote control.

- 1) Press ▲▼ to select [CONTROL DEVICE SETUP].
- 2) Press the <ENTER> button.
 - The [CONTROL DEVICE SETUP] screen is displayed.
- 3) Press ▲▼ to select [CONTROL PANEL] or [REMOTE CONTROL].

[CONTROL PANEL]	Sets the limitation on the control from the control panel.
[REMOTE CONTROL]	Sets the limitation on the control from the remote control.

- 4) Press the <ENTER> button.
 - The [CONTROL PANEL] screen or the [REMOTE CONTROL] screen is displayed.
- 5) Press ▲▼ to select [CONTROL PANEL] or [REMOTE CONTROL].
- 6) Press ◀▶ to switch the item.
 - You can set the operation restriction from the control panel or the remote control.

[ENABLE]	Enables all button operations.
[DISABLE]	Disables all button operations.
[USER]	Operation of all buttons can be enabled/disabled separately. Refer to “Enabling/disabling any button” (▶ page 135) for details.

- 7) Press ▲▼ to select [APPLY], and press the <ENTER> button.
 - The confirmation screen is displayed.
- 8) Press ◀▶ to select [OK], and press the <ENTER> button.

Enabling/disabling any button

- 1) Press ▲▼ to select [CONTROL DEVICE SETUP].
- 2) Press the <ENTER> button.
 - The [CONTROL DEVICE SETUP] screen is displayed.
- 3) Press ▲▼ to select [CONTROL PANEL] or [REMOTE CONTROL].
- 4) Press the <ENTER> button.
 - The [CONTROL PANEL] screen or the [REMOTE CONTROL] screen is displayed.
- 5) Press ▲▼ to select [CONTROL PANEL] or [REMOTE CONTROL].
- 6) Press ◀▶ to switch [USER].
- 7) Press ▲▼ to select the button item to set.
 - When [INPUT SELECT BUTTON] is selected in [REMOTE CONTROL], press the <ENTER> button, and then press ▲▼ to select the button to set.

	Buttons that can be set	
	[CONTROL PANEL]	[REMOTE CONTROL]
[POWER BUTTON]	Power <⏻/ >button	
[INPUT SELECT BUTTON]	<INPUT SELECT> button	<COMPUTER> button, <HDMI 1> button, <HDMI 2> button, <HDMI 3> button, <DIGITAL LINK> button
[MENU BUTTON]	<MENU> button	
[LENS BUTTON]	<LENS/CANCEL> button	Lens buttons (<FOCUS>, <ZOOM>, <SHIFT>)
[AUTO SETUP BUTTON]	—	<AUTO SETUP/CANCEL> button
[SHUTTER BUTTON]	<SHUTTER> button	
[ON SCREEN BUTTON]	—	<ON SCREEN> button
[OTHER BUTTON]	▲▼◀▶, <ENTER> button	Buttons not listed above

8) Press ◀▶ to switch the item.

[ENABLE]	Enables button operations.
[DISABLE]	Disables button operations.

- When [INPUT SELECT BUTTON] is selected in Step 7), pressing the <MENU> button returns to the [CONTROL PANEL] screen or the [REMOTE CONTROL] screen once the item is switched.

9) Press ▲▼ to select [APPLY], and press the <ENTER> button.

- The confirmation screen is displayed.

10) Press ◀▶ to select [OK], and press the <ENTER> button.

Note

- When a button operation is performed on the the control panel or remote control where [DISABLE] is set, the [CONTROL DEVICE PASSWORD] screen is displayed.
Enter the control device password.
- The [CONTROL DEVICE PASSWORD] screen will disappear when there is no operation for approx. 10 seconds.
- When the setting has completed, the menu screen will disappear. To operate continuously, press the <MENU> button to display the main menu.
- Even when you set button operations on the remote control disabled, operations of the <ID SET> and <ID ALL> buttons on the remote control are kept enabled.

[CONTROL DEVICE PASSWORD CHANGE]

The control device password can be changed.

1) Press ▲▼ to select [CONTROL DEVICE PASSWORD CHANGE].

2) Press the <ENTER> button.

- The [CONTROL DEVICE PASSWORD CHANGE] screen is displayed.

3) Press ▲▼◀▶ to select the text, and press the <ENTER> button to enter the text.

4) Press ▲▼◀▶ to select [OK], and press the <ENTER> button.

- To cancel, select [CANCEL].

Attention

- The initial password is "AAAA" as the factory default or when the [PROJECTOR SETUP] menu → [INITIALIZE] → [ALL USER DATA] is executed.
- Change the password periodically that is hard to guess.
- To initialize your password, consult your distributor.

[NETWORK] menu

On the menu screen, select [NETWORK] from the main menu, and select an item from the sub-menu. Refer to “Navigating through the menu” (➔ page 74) for the operation of the menu screen.

[ETHERNET TYPE]

Set the path for transmitting the Ethernet signal.

- 1) Press ▲▼ to select [ETHERNET TYPE].
- 2) Press the <ENTER> button.
 - The [ETHERNET TYPE] screen is displayed.
- 3) Press ▲▼ to switch the item.
 - The items will switch each time you press the button.

[LAN]	Select this item when using only the <LAN> terminal to transmit the Ethernet signal.
[DIGITAL LINK]	Select this item when using only the <DIGITAL LINK/LAN> terminal to transmit the Ethernet signal.
[LAN & DIGITAL LINK]	Select this item when using the <DIGITAL LINK/LAN> terminal and the <LAN> terminal to transmit the Ethernet signal.

- 4) Press the <ENTER> button.

Note

- When [ETHERNET TYPE] is set to [LAN], the Ethernet and serial control signals cannot be transmitted via the optional DIGITAL LINK output supported device (Model No.: ET-YFB100G, ET-YFB200G) connected to the <DIGITAL LINK/LAN> terminal.
- When [ETHERNET TYPE] is set to [LAN & DIGITAL LINK], the <DIGITAL LINK/LAN> terminal and the <LAN> terminal are connected inside the projector. Do not directly connect the <DIGITAL LINK/LAN> terminal and the <LAN> terminal using a LAN cable. Construct the system so that it is not connected to the same network via the peripherals such as the switching hub or the twisted-pair-cable transmitter.

[DIGITAL LINK]

Make settings and operations related to DIGITAL LINK.

[DIGITAL LINK MODE]

Switch the communication method of the <DIGITAL LINK/LAN> terminal of the projector.

- 1) Press ▲▼ to select [DIGITAL LINK].
- 2) Press the <ENTER> button.
 - The [DIGITAL LINK] screen is displayed.
- 3) Press ▲▼ to select [DIGITAL LINK MODE].
- 4) Press ◀▶ to switch the item.
 - The items will switch each time you press the button.

[AUTO]	Switches the communication method automatically to DIGITAL LINK, long reach, or Ethernet.
[DIGITAL LINK]	Fixes the communication method to DIGITAL LINK.
[LONG REACH]	Fixes the communication method to long reach.
[ETHERNET]	Fixes the communication method to Ethernet.

Possible communication modes

- ✓: Communication possible
- : Communication not possible

Setting		Communication possible			
		Video transfer (100 m (328'1"))	Video transfer (150 m (492'2"))	Ethernet	RS-232C
[AUTO]	For DIGITAL LINK	✓	—	✓	✓
	For long reach	—	✓	✓	✓
	For Ethernet	—	—	✓ ^{*1}	—
[DIGITAL LINK]		✓	—	✓	✓
[LONG REACH]		—	✓	✓	✓
[ETHERNET]		—	—	✓ ^{*1}	—

*1 Communication via a twisted-pair-cable transmitter is not available. Connect the projector to the network directly.

Note

- The maximum transmission distance between the twisted-pair-cable transmitter and the projector is 100 m (328'1") for the signal with resolution of 1 920 x 1 200 dots or less. For the signal with the resolution exceeding 1 920 x 1 200 dots, the maximum transmission distance will be 50 m (164'1").
- The maximum transmission distance when connected with the long-reach communication method is 150 m (492'2"). In this case, the signal that the projector can receive is only up to 1080/60p (1 920 x 1 080 dots, dot clock frequency 148.5 MHz).
- When the communication method of the twisted-pair-cable transmitter is set to long reach, the projector will connect with long-reach communication method when [DIGITAL LINK MODE] is set to [AUTO]. To connect with the optional DIGITAL LINK Switcher (Model No.: ET-YFB200G) with the long-reach communication method, set [DIGITAL LINK MODE] to [LONG REACH].
- Connection will not be made correctly if the twisted-pair-cable transmitter is not supporting the long-reach communication method even if [DIGITAL LINK MODE] is set to [LONG REACH].

[DIGITAL LINK STATUS]

Display the DIGITAL LINK connection environment.

- 1) Press ▲▼ to select [DIGITAL LINK].
- 2) Press the <ENTER> button.
 - The [DIGITAL LINK] screen is displayed.
- 3) Press ▲▼ to select [DIGITAL LINK STATUS].
- 4) Press the <ENTER> button.
 - The [DIGITAL LINK STATUS] screen is displayed.

[LINK STATUS]	One of [NO LINK], [DIGITAL LINK], [LONG REACH], or [ETHERNET] is displayed.
[HDCP STATUS]	One of [NO SIGNAL], [OFF], or [ON] is displayed.
[SIGNAL QUALITY]	<p>[SIGNAL QUALITY] is a numerical value of the amount of error, and the display color changes to green, yellow, or red depending on that value. Check the signal quality level while receiving a signal from the twisted-pair-cable transmitter.</p> <ul style="list-style-type: none"> • [MAX]/[MIN]: Maximum/minimum value of the amount of error • Green (-12 dB or lower) → normal signal quality level. • Yellow (-11 to -8 dB) → caution level that noise may appear on the screen. • Red (-7 dB or more) → abnormal level that synchronization is disrupted or not possible to receive.

[DIGITAL LINK MENU]

When the optional DIGITAL LINK output supported device (Model No.: ET-YFB100G, ET-YFB200G) is connected to the <DIGITAL LINK/LAN> terminal, the main menu of the connected DIGITAL LINK output supported device is displayed. Refer to the Operating Instructions of the DIGITAL LINK output supported device for details.

Note

- [DIGITAL LINK MENU] cannot be selected when the [NETWORK] menu → [DIGITAL LINK] → [EXTRON XTP] is set to [ON].

[EXTRON XTP]

Make connection setting for the "XTP transmitter" of Extron Electronics.

- 1) Press ▲▼ to select [DIGITAL LINK].

- 2) Press the <ENTER> button.
 - The [DIGITAL LINK] screen is displayed.
- 3) Press ▲▼ to select [EXTRON XTP].
- 4) Press ◀▶ to switch the item.
 - The items will switch each time you press the button.

[OFF]	Select this item when connecting the optional DIGITAL LINK output supported device (Model No.: ET-YFB100G, ET-YFB200G) to the <DIGITAL LINK/LAN> terminal.
[ON]	Select this item when connecting the “XTP transmitter” of Extron Electronics to the <DIGITAL LINK/LAN> terminal.

Note

- For details of the “XTP transmitter”, visit the website of Extron Electronics.
URL <http://www.extron.com/>

[WIRED LAN]

Perform the connection setting to use the wired LAN.

- 1) Press ▲▼ to select [WIRED LAN].
- 2) Press the <ENTER> button.
 - The [WIRED LAN] screen is displayed.
- 3) Press ▲▼ to select an item, and change the settings according to the operation instructions of the menu.

[DHCP]	[ON]	If a DHCP server exists in the network where the projector is to be connected, obtains the IP address automatically.
	[OFF]	If a DHCP server does not exist in the network where the projector is to be connected, set [IP ADDRESS], [SUBNET MASK], and [DEFAULT GATEWAY].
[IP ADDRESS]	Enter the IP address when a DHCP server is not used.	
[SUBNET MASK]	Enter the subnet mask when a DHCP server is not used.	
[DEFAULT GATEWAY]	Enter the default gateway address when a DHCP server is not used.	

- 4) Press ▲▼ to select [STORE], and press the <ENTER> button.
 - The confirmation screen is displayed.
- 5) Press ◀▶ to select [OK], and press the <ENTER> button.

Note

- When using a DHCP server, confirm that the DHCP server is running.
- Consult your network administrator regarding the IP address, subnet mask, and default gateway.
- The network setting is common for the <LAN> terminal and the <DIGITAL LINK/LAN> terminal.
- [WIRED LAN] cannot be selected when the [NETWORK] menu → [Art-Net] → [Art-Net SETUP] is set to [ON(2.X.X.X)] or [ON(10.X.X.X)].

[PROJECTOR NAME]

Name of the projector can be changed. Enter if a host name is required when using the DHCP server, etc.

- 1) Press ▲▼ to select [PROJECTOR NAME].
- 2) Press the <ENTER> button.
 - The [PROJECTOR NAME CHANGE] screen is displayed.
- 3) Press ▲▼◀▶ to select the character, and press the <ENTER> button to enter the character.
 - Up to 12 characters can be entered.
- 4) Once the entry of the projector name is completed, press ▲▼◀▶ to select [OK], and press the <ENTER> button.
 - To cancel, select [CANCEL].

Note

- The factory default of the projector name is "Namexxxx". xxxx is the four digit number assigned for each product.

[NETWORK STATUS]

Display the status of the projector network.

- 1) Press ▲▼ to select [NETWORK STATUS].
- 2) Press the <ENTER> button.
 - The [NETWORK STATUS] screen is displayed.

[DHCP]	Displays the status of use of DHCP server.
[IP ADDRESS]	Displays the [IP ADDRESS].
[SUBNET MASK]	Displays the [SUBNET MASK].
[DEFAULT GATEWAY]	Displays the [DEFAULT GATEWAY].
[DNS1]	Displays the address of the preferred DNS server.
[DNS2]	Displays the address of the alternate DNS server.
[MAC ADDRESS]	Displays the [MAC ADDRESS] of wired LAN.

Note

- The network setting is common for the <LAN> terminal and the <DIGITAL LINK/LAN> terminal.

[ADMINISTRATOR ACCOUNT]

Set the user name and password of the administrator account.

[PASSWORD POLICY]

Display the policies about the password for the administrator account.

- 1) Press ▲▼ to select [ADMINISTRATOR ACCOUNT].
- 2) Press the <ENTER> button.
 - The [ADMINISTRATOR ACCOUNT] screen is displayed.
- 3) Press ▲▼ to select [PASSWORD POLICY], and press the <ENTER> button.
 - The [PASSWORD POLICY] screen is displayed.

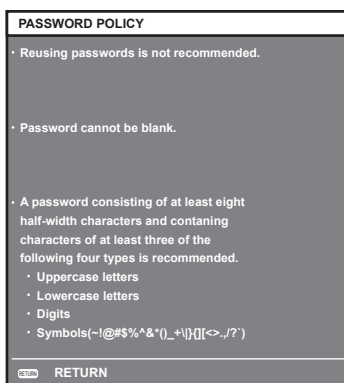
**Setting the administrator account for the first time**

Set the user name and password of the administrator account.

- 1) Press ▲▼ to select [ADMINISTRATOR ACCOUNT].
- 2) Press the <ENTER> button.
 - The [ADMINISTRATOR ACCOUNT] screen is displayed.
- 3) Press ▲▼ to select [USER NAME], and press the <ENTER> button.
 - The [USER NAME] screen is displayed.
 - The factory default setting of user name is "dispadmin".

- 4) Press ▲▼◀▶ to select a character, and press the <ENTER> button.
 - Up to 16 characters can be entered.
- 5) After entering the user name, press ▲▼◀▶ to select [OK], and press the <ENTER> button.
 - The [ADMINISTRATOR ACCOUNT] screen is displayed.
- 6) Press ▲▼ to select [PASSWORD], and press the <ENTER> button.
 - The [PASSWORD] screen is displayed.
- 7) Press ▲▼◀▶ to select a character, and press the <ENTER> button.
 - Up to 16 characters can be entered.
 - The password cannot be blank.
- 8) After entering the password, press ▲▼◀▶ to select [OK], and press the <ENTER> button.
 - The [ADMINISTRATOR ACCOUNT] screen is displayed.
- 9) Press ▲▼ to select [PASSWORD CONFIRM], and press the <ENTER> button.
 - The [PASSWORD CONFIRM] screen is displayed.
- 10) Enter the password entered in Step 7).
- 11) After entering the password, press ▲▼◀▶ to select [OK], and press the <ENTER> button.
 - The [ADMINISTRATOR ACCOUNT] screen is displayed.
- 12) Press ▲▼ to select [STORE], and press the <ENTER> button.
 - The confirmation screen is displayed.
- 13) Press ◀▶ to select [OK], and press the <ENTER> button.

Note

- For restrictions on character strings that can be set for password, refer to [PASSWORD POLICY] (▶ page 140) .
- If the password of the administrator account has not been set, that is, if it is left blank, the network function of this projector cannot be used. Set a password before using the web control function or the communication control (including operation with application software) via LAN.
- The user name and password of a standard user account without administrator rights can be set on the [Set up password] page (▶ page 162) of the web control screen.

Changing settings of the administrator account

Change the user name and password of the administrator account.

- 1) Press ▲▼ to select [ADMINISTRATOR ACCOUNT].
- 2) Press the <ENTER> button.
 - The [ADMINISTRATOR ACCOUNT] screen is displayed.
- 3) Press ▲▼ to select [USER NAME] under [CURRENT], and press the <ENTER> button.
 - The [USER NAME] screen is displayed.
- 4) Press ▲▼◀▶ to select a character, and press the <ENTER> button.
 - Enter the current user name.
- 5) After entering the user name, press ▲▼◀▶ to select [OK], and press the <ENTER> button.
 - The [ADMINISTRATOR ACCOUNT] screen is displayed.
- 6) Press ▲▼ to select [PASSWORD] under [CURRENT], and press the <ENTER> button.
 - The [PASSWORD] screen is displayed.
- 7) Press ▲▼◀▶ to select a character, and press the <ENTER> button.
 - Enter the current password.
- 8) After entering the password, press ▲▼◀▶ to select [OK], and press the <ENTER> button.
 - The [ADMINISTRATOR ACCOUNT] screen is displayed.
- 9) Press ▲▼ to select [USER NAME] under [NEW], and press the <ENTER> button.
 - The [USER NAME] screen is displayed.
- 10) Press ▲▼◀▶ to select a character, and press the <ENTER> button.

- Enter a new user name.
 - Enter the current user name if you do not want to change it.
 - Up to 16 characters can be entered.
- 11) **After entering the user name, press ▲▼◀▶ to select [OK], and press the <ENTER> button.**
 - The [ADMINISTRATOR ACCOUNT] screen is displayed.
 - 12) **Press ▲▼ to select [PASSWORD] under [NEW], and press the <ENTER> button.**
 - The [PASSWORD] screen is displayed.
 - 13) **Press ▲▼◀▶ to select a character, and press the <ENTER> button.**
 - Enter a new password.
 - Up to 16 characters can be entered.
 - Enter the current password if you do not want to change it.
 - 14) **After entering the password, press ▲▼◀▶ to select [OK], and press the <ENTER> button.**
 - The [ADMINISTRATOR ACCOUNT] screen is displayed.
 - 15) **Press ▲▼ to select [PASSWORD CONFIRM] under [NEW], and press the <ENTER> button.**
 - The [PASSWORD CONFIRM] screen is displayed.
 - 16) **Enter the password entered in Step 13).**
 - 17) **After entering the password, press ▲▼◀▶ to select [OK], and press the <ENTER> button.**
 - The [ADMINISTRATOR ACCOUNT] screen is displayed.
 - 18) **Press ▲▼ to select [STORE], and press the <ENTER> button.**
 - The confirmation screen is displayed.
 - 19) **Press ◀▶ to select [OK], and press the <ENTER> button.**

Note

- For restrictions on character strings that can be set for password, refer to [PASSWORD POLICY] (➡ page 140) .
- The user name and password of the administrator account can also be changed on the [Set up password] page (➡ page 162) of the web control screen.
- The user name and password of a standard user account without administrator rights can be set on the [Set up password] page (➡ page 162) of the web control screen.

[NETWORK SECURITY]

Make settings to protect the projector from external attacks via LAN and unauthorized use. Setting the password of the administrator account (➡ page 140) is required for setting the [NETWORK SECURITY] menu.

[COMMAND PROTECT]

Make settings for the connection authentication when using the command control function.

- 1) **Press ▲▼ to select [NETWORK SECURITY].**
- 2) **Press the <ENTER> button.**
 - The [NETWORK SECURITY] screen is displayed.
- 3) **Press ◀▶ to switch the [COMMAND PROTECT] setting.**

[ENABLE]	Connect to the projector in protected mode. The user name and password of the administrator account are required for the connection authentication.
[DISABLE]	Connect to the projector in non-protected mode. Connection authentication is not performed.

- The confirmation screen is displayed once the setting is switched.
- 4) **Press ◀▶ to select [OK], and press the <ENTER> button.**
 - The [COMMAND PROTECT] screen is displayed.
 - 5) **Press ▲▼ to select [PASSWORD], and press the <ENTER> button.**

- The [PASSWORD] screen is displayed.
- 6) Press ▲▼◀▶ to select a character, and press the <ENTER> button.
 - Enter the password of the administrator account.
 - 7) After entering the password, press ▲▼◀▶ to select [OK], and press the <ENTER> button.
 - The [COMMAND PROTECT] screen is displayed.
 - 8) Press ▲▼◀▶ to select [OK], and press the <ENTER> button.

Note

- When [COMMAND PROTECT] is set to [DISABLE], connection authentication is not performed, making it vulnerable to threats on the network. Be aware of the risks before making settings.
- For details on how to use the command control function, refer to "Control commands via LAN". (➔ page 191)

[NETWORK CONTROL]

Set the network control of this projector.

Setting the password of the administrator account (➔ page 140) is required for using the network function of the projector.

- 1) Press ▲▼ to select [NETWORK CONTROL].
- 2) Press the <ENTER> button.
 - The [NETWORK CONTROL] screen is displayed.
- 3) Press ▲▼ to select an item, and press ◀▶ to change the setting.

[WEB CONTROL]	Set to [ON] to control with the web browser.
[COMMAND CONTROL]	Set to [ON] to control with the control command format (➔ page 197) for the <SERIAL/MULTI SYNC IN> terminal. Refer to "Control commands via LAN" (➔ page 191).
[COMMAND PORT]	Set the port number used for command control.
[Crestron Connected(TM)]	Set to [ON] to control with Crestron Connected of Crestron Electronics, Inc.
[AMX D.D.]	Set to [ON] to control with the controller of AMX Corporation. Setting this function to [ON] enables detection through "AMX Device Discovery". For details, visit the website of AMX Corporation. URL http://www.amx.com/

- 4) Press ▲▼ to select [STORE], and press the <ENTER> button.
 - The confirmation screen is displayed.
- 5) Press ◀▶ to select [OK], and press the <ENTER> button.

Note

- If the password of the administrator account has not been set, that is, if it is left blank, the network function of this projector cannot be used. Set a password before using the web control function or the communication control (including operation with application software) via LAN.

[PJLink]

Set the PJLink function to control and monitor the projector using the PJLink protocol.

Setting the password of the administrator account (➔ page 140) is required for using the PJLink function of the projector.

Note

- If the password of the administrator account has not been set, that is, if it is left blank, the network function of this projector cannot be used. Set a password before using the web control function or the communication control (including operation with application software) via LAN.

[PJLink PASSWORD]

Set the password for security authentication which is required when connecting to the projector.

- 1) Press ▲▼ to select [PJLink].
- 2) Press the <ENTER> button.
 - The [PJLink] screen is displayed.
- 3) Press ▲▼ to select [PJLink PASSWORD], and press the <ENTER> button.

- The [PJLink PASSWORD] screen is displayed.
- 4) Press ▲▼ to select [PASSWORD] under [CURRENT], and press the <ENTER> button.
 - The [PASSWORD] screen is displayed.
 - 5) Press ▲▼◀▶ to select a character, and press the <ENTER> button.
 - Enter the current password.
 - The factory default setting of password is blank.
 - 6) After entering the password, press ▲▼◀▶ to select [OK], and press the <ENTER> button.
 - The [PJLink PASSWORD] screen is displayed.
 - 7) Press ▲▼ to select [PASSWORD] under [NEW], and press the <ENTER> button.
 - The [PASSWORD] screen is displayed.
 - 8) Press ▲▼◀▶ to select a character, and press the <ENTER> button.
 - Enter a new password.
 - Up to 32 alphanumeric characters can be entered.
 - 9) After entering the password, press ▲▼◀▶ to select [OK], and press the <ENTER> button.
 - The [PJLink PASSWORD] screen is displayed.
 - 10) Press ▲▼ to select [PASSWORD CONFIRM], and press the <ENTER> button.
 - The [PASSWORD CONFIRM] screen is displayed.
 - 11) Enter the password entered in Step 8).
 - 12) After entering the password, press ▲▼◀▶ to select [OK], and press the <ENTER> button.
 - The [PJLink PASSWORD] screen is displayed.
 - 13) Press ▲▼ to select [STORE], and press the <ENTER> button.
 - The confirmation screen is displayed.
 - 14) Press ◀▶ to select [OK], and press the <ENTER> button.

Note

- The PJLink password can also be changed on the [Set up password] page (➔ page 162) of the web control screen.

[PJLink CONTROL]

Set to enable or disable the PJLink protocol control function.

- 1) Press ▲▼ to select [PJLink].
- 2) Press the <ENTER> button.
 - The [PJLink] screen is displayed.
- 3) Press ▲▼ to select [PJLink CONTROL].
- 4) Press ◀▶ to switch the item.
 - The items will switch each time you press the button.

[ON]	Enables PJLink protocol control function.
[OFF]	Disables PJLink protocol control function.

[PJLink NOTIFICATION]

Set to enable or disable the PJLink notification function.

- 1) Press ▲▼ to select [PJLink].
- 2) Press the <ENTER> button.
 - The [PJLink] screen is displayed.
- 3) Press ▲▼ to select [PJLink NOTIFICATION].

4) Press ◀▶ to switch the item.

- The items will switch each time you press the button.

[OFF]	Disables the PJLink notification function.
[ON]	Enables the PJLink notification function.

- If [ON] is selected, proceed to Step 5).

5) Press ▲▼ to select [NOTIFIED IP ADDRESS 1] or [NOTIFIED IP ADDRESS 2].

- Enter the IP address of the computer to notify the status of the projector.

[Art-Net]

Set the Art-Net function.

Setting the password of the administrator account (➔ page 140) is required for using the Art-Net function of the projector.

Note

- If the password of the administrator account has not been set, that is, if it is left blank, the network function of this projector cannot be used. Set a password before using the web control function or the communication control (including operation with application software) via LAN.

[Art-Net SETUP]

Make settings to use the Art-Net function.

1) Press ▲▼ to select [Art-Net].

2) Press the <ENTER> button.

- The [Art-Net] screen is displayed.

3) Press ▲▼ to select [Art-Net SETUP].

4) Press ◀▶ to switch the item.

- The items will switch each time you press the button.

[OFF]	Disables the Art-Net function.
[ON(2.X.X.X)]	Enables the Art-Net function and sets the IP address to 2.X.X.X.
[ON(10.X.X.X)]	Enables the Art-Net function and sets the IP address to 10.X.X.X.
[ON(MANUAL)]	Enables the Art-Net function and uses the IP address set in [WIRED LAN].

- Proceed to Step 5) when anything other than [OFF] is selected.

5) Press the <ENTER> button.

- The [Art-Net SETUP] screen is displayed.

6) Press ▲▼ to select an item, and press ◀▶ to switch the setting.

[NET]	Enter [NET] to be used when the projector processes Art-Net.
[SUB NET]	Enter [SUB NET] to be used when the projector processes Art-Net.
[UNIVERSE]	Enter [UNIVERSE] to be used when the projector processes Art-Net.
[START ADDRESS]	Enter [START ADDRESS] to be used when the projector processes Art-Net.

7) Press ▲▼ to select [STORE], and press the <ENTER> button.

- The confirmation screen is displayed.

8) Press ◀▶ to select [OK], and press the <ENTER> button.

Note

- If [ON(2.X.X.X)] or [ON(10.X.X.X)] is selected, IP address is calculated and set automatically.
- The network setting is common for the <LAN> terminal and the <DIGITAL LINK/LAN> terminal.

[Art-Net CHANNEL SETTING]

Set the assignment of the channel.

For the channel definitions used for controlling the projector with the Art-Net function, refer to “Using Art-Net function” (➔ page 187).

- 1) Press ▲▼ to select [Art-Net].
- 2) Press the <ENTER> button.
 - The [Art-Net] screen is displayed.
- 3) Press ▲▼ to select [Art-Net CHANNEL SETTING].
- 4) Press ◀▶ to switch the item.

[2]	Uses the channel assignment in standard setting.
[USER]	Changes the channel assignment.
[1]	Uses the channel assignment with DZ21K series compatible. DZ21K series: DZ21K series, DS20K series, DW17K series, DZ16K series

- When [2] or [1] is selected, the function assigned to the channel is displayed by pressing the <ENTER> button.
- When [USER] is selected, proceed to Step 5).

- 5) Press the <ENTER> button.
 - The [CHANNEL SETUP] screen is displayed.
- 6) Press ▲▼ to select the channel to set, and press ◀▶ to switch the item.

[LIGHT OUTPUT]	Adjusts the amount of light.
[INPUT SELECT]	Switches the input.
[LENS POSITION]	Moves the lens position.
[LENS H SHIFT]	Adjusts the lens shift in the horizontal direction.
[LENS V SHIFT]	Adjusts the lens shift in the vertical direction.
[LENS FOCUS]	Adjusts the focus.
[LENS ZOOM]	Adjusts the zoom.
[POWER]	Controls the power status.
[SHUTTER]	Controls the shutter function.
[FADE-IN]	Sets the fade-in time.
[FADE-OUT]	Sets the fade-out time.
[SCREEN ADJUSTMENT]	Performs screen correction.
[FREEZE]	Freezes the projected image, and turns off the audio.
[COLOR]	Adjusts the color saturation.
[TINT]	Adjusts the tint.
[RASTER PATTERN]	Displays the raster pattern.
[AUDIO VOLUME]	Adjusts the volume.
[ENABLE / DISABLE]	Enables/disables the control of the projector with the Art-Net function.
[NONE]	No definition

- The setting can be also made by pressing ▲▼ to select the channel, pressing the <ENTER> button to display the item list, pressing ▲▼◀▶ to select the item, and pressing the <ENTER> button.
- Same item cannot be set for multiple channels, except for [NONE].

[Art-Net STATUS]

Display the content of control assigned to each channel and the received data of that channel.

- 1) Press ▲▼ to select [Art-Net].
- 2) Press the <ENTER> button.
 - The [Art-Net] screen is displayed.
- 3) Press ▲▼ to select [Art-Net STATUS].
- 4) Press the <ENTER> button.
 - The [Art-Net STATUS] screen is displayed

Chapter 5 Operations

This chapter describes how to use each function.

Network connection

The projector is equipped with the network function, and following is possible by connecting to a computer.

- **Web control**

Setting, adjustment, and displaying status of the projector are possible by accessing the projector from a computer.

Refer to “Web control function” (➔ page 151) for details.

- **Smart Projector Control**

This application software sets and adjusts the projector connected via LAN using a smartphone or a tablet.

For details or downloading application software, visit the website (<https://panasonic.net/cns/projector/>).

- **Multi Monitoring & Control Software**

“Multi Monitoring & Control Software”, a software application to monitor and control multiple display devices (projector or flat panel display) connected to intranet, can be used.

Plug-in software “Early Warning Software”, which monitors the status of the display devices and their peripherals within an intranet, and notifies of abnormality of such equipment and detects the signs of possible abnormality, can also be used.

For details, visit the website (<https://panasonic.net/cns/projector/>).

- **PJLink**

Operation or status query of the projector can be performed from a computer using the PJLink protocol.

Refer to “Using the PJLink function” (➔ page 186) for details.

- **Art-Net**

Setting of the projector can be operated by the DMX controller or application software using the Art-Net protocol.

Refer to “Using Art-Net function” (➔ page 187) for details.

- **Command control**

Operation or status query of the projector can be performed from a computer using the control command.

Refer to “Control commands via LAN” (➔ page 191) for details.

Note

- If the password of the administrator account has not been set, that is, if it is left blank, the network function of this projector cannot be used. Set a password before using the web control function or the communication control (including operation with application software) via LAN.

Connecting via wired LAN

This projector can receive the Ethernet signal from the twisted-pair-cable transmitter via a LAN cable.

Example of general network connection

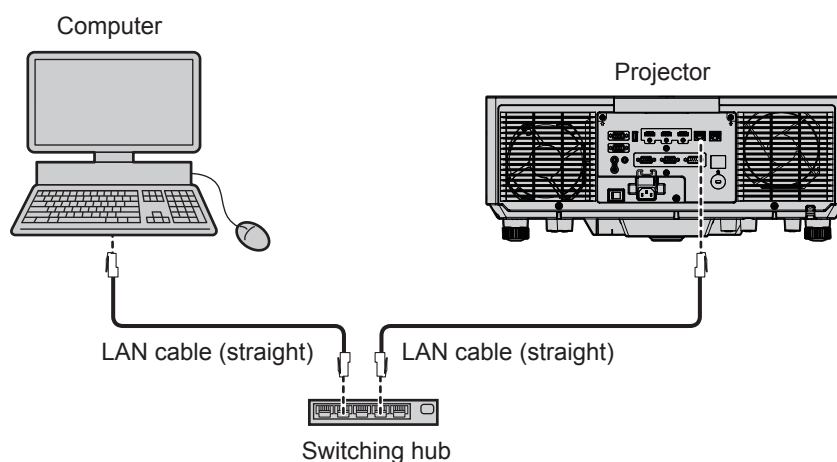

Attention

- When a LAN cable is directly connected to the projector, the network connection must be made indoors.

Note

- A LAN cable is required to use the network function via wired LAN.
- Connect a LAN cable to send and receive the Ethernet signal to the <LAN> terminal or the <DIGITAL LINK/LAN> terminal of the projector.
- Use a straight or crossover LAN cable that is compatible with CAT5 or higher. Either the straight or the crossover cable, or both cables can be used depending on the system configuration. Consult your network administrator. The projector will determine the type of the cable (straight

- or crossover) automatically.
- Use a LAN cable of 100 m (328'1") or shorter.

Example of network connections via a twisted-pair-cable transmitter

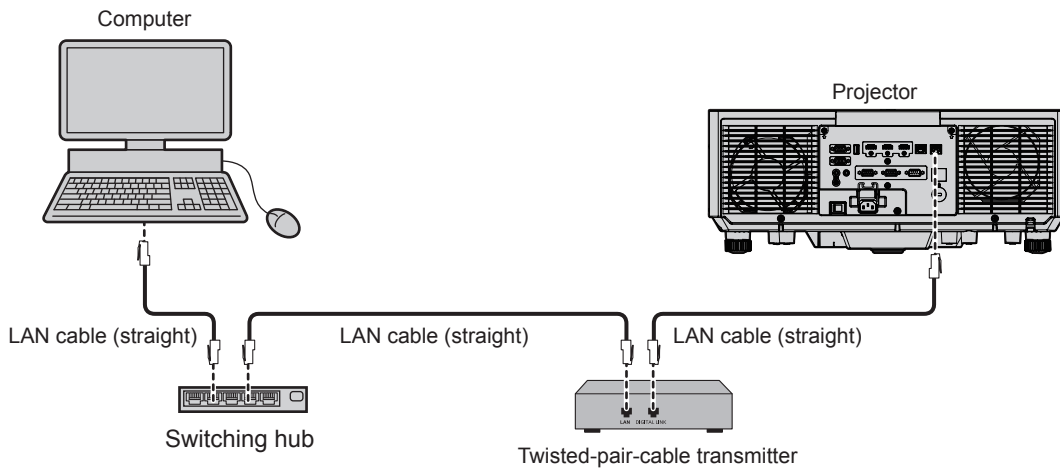

Attention

- When a LAN cable is directly connected to the projector, the network connection must be made indoors.

Note

- For the LAN cable between the twisted-pair-cable transmitter and the projector, use a cable that meets the following criteria:
 - Conforming to CAT5e or higher standards
 - Shielded type (including connectors)
 - Straight-through
 - Single wire
 - Diameter of the cable core is same or larger than AWG24 (AWG24, AWG23, etc.)
- The maximum transmission distance between the twisted-pair-cable transmitter and the projector is 100 m (328'1") for the signal with resolution of 1 920 x 1 200 dots or less. For the signal with the resolution exceeding 1 920 x 1 200 dots, the maximum transmission distance will be 50 m (164'1"). It is possible to transmit up to 150 m (492'2") if the twisted-pair-cable transmitter supports the long-reach communication method. However, the signal that the projector can receive is only up to 1080/60p (1 920 x 1 080 dots, dot clock frequency 148.5 MHz) for the long-reach communication method. If this distance is exceeded, image may be disrupted or a malfunction may occur in LAN communication.
- When laying cables between the twisted-pair-cable transmitter and the projector, confirm that cable characteristics are compatible with CAT5e or higher using tools such as a cable tester or cable analyzer. When a relay connector is used, include it in the measurement.
- Do not use a switching hub between the twisted-pair-cable transmitter and the projector.
- To transmit the Ethernet and serial control signals using the <DIGITAL LINK/LAN> terminal, set the [NETWORK] menu → [ETHERNET TYPE] to [DIGITAL LINK] or [LAN & DIGITAL LINK].
- To transmit the Ethernet signal using the <LAN> terminal, set the [NETWORK] menu → [ETHERNET TYPE] to [LAN] or [LAN & DIGITAL LINK].
- The <DIGITAL LINK/LAN> terminal and the <LAN> terminal are connected inside of the projector when the [NETWORK] menu → [ETHERNET TYPE] is set to [LAN & DIGITAL LINK]. Do not directly connect the <DIGITAL LINK/LAN> terminal and the <LAN> terminal using a LAN cable. Construct the system so that it is not connected to the same network via the peripherals such as the switching hub or the twisted-pair-cable transmitter.
- Do not pull cables forcefully. Also, do not bend or fold cables unnecessarily.
- To reduce the effects of noise as much as possible, stretch out the cables between the twisted-pair-cable transmitter and the projector without any loops.
- Lay the cables between the twisted-pair-cable transmitter and the projector away from other cables, particularly power cables.
- When laying multiple cables, run them side by side along the shortest distance possible without bundling them together.
- After laying the cable, confirm that the value of [SIGNAL QUALITY] in the [NETWORK] menu → [DIGITAL LINK] → [DIGITAL LINK STATUS] is displayed in green, which indicates a normal quality.
- For twisted-pair-cable transmitters of other manufacturers that the operation has been verified with this projector, visit the website (<https://panasonic.net/cns/projector/>). Note that the verification for devices of other manufacturers has been made for the items set by Panasonic Connect Co., Ltd., and not all the operations have been verified. For operation or performance problems caused by the devices of other manufacturers, contact the respective manufacturers.

Setting the projector

- 1) Connect the projector to a computer using a LAN cable.
- 2) Turn on the power of the projector.
- 3) From the main menu, select the [NETWORK] menu → [WIRED LAN], and press the <ENTER> button.

4) Perform the [WIRED LAN] setting.

- For details, refer to [WIRED LAN] (➔ page 139).

Note

- To connect to an existing network, perform after consulting your network administrator.

■ Factory default setting

- Following is preset as the factory default setting.

[DHCP]	OFF
[IP ADDRESS]	192.168.0.8
[SUBNET MASK]	255.255.255.0
[DEFAULT GATEWAY]	192.168.0.1
[DNS1]/[DNS2]	None

Operating the computer**1) Turn on the power of the computer.****2) Perform the network setting following the instruction of your network administrator.**

- Operation from the computer is possible by configuring the network setting of the computer as follows if the projector is in the factory default setting.

[IP ADDRESS]	192.168.0.10
[SUBNET MASK]	255.255.255.0
[DEFAULT GATEWAY]	192.168.0.1

Web control function

Following operation is possible from a computer using the web control function.

- Setting and adjustment of the projector
- Display of the projector status
- Sending E-mail messages when there is a problem with the projector

The projector supports “Crestron Connected”, and the following application software of Crestron Electronics, Inc. can be used.

- RoomView Express
- Crestron Fusion

Note

- Communication with an E-mail server is required to use the E-mail function. Confirm that the E-mail can be used beforehand.
- “Crestron Connected” is a system of Crestron Electronics, Inc. that collectively manages and controls devices on multiple systems connected to a network using a computer.
- For details of the “Crestron Connected”, visit the website of Crestron Electronics, Inc. (English only.)
URL <https://www.crestron.com/>
Download “RoomView Express” from the Crestron Electronics, Inc. website. (English only.)
URL <https://www.crestron.com/resources/get-roomview>

Computer that can be used for setting

To use the web control function, a web browser is required. Confirm that the web browser can be used in advance.

OS	Compatible browser
Windows	Internet Explorer 11.0 Microsoft Edge
Mac OS	Safari 10.0/11.0/12.0/13.0/14.0
iOS	Safari (version equipped with iOS 10, iOS 11, iOS 12, iOS 13, iOS 14)
Android	Google Chrome (version equipped with Android 6.0/7.0/8.0/9.0/10.0/11.0)

Accessing from the web browser

- 1) Start up the web browser on the computer.
- 2) Enter the IP address set on the projector into the URL entry field of the web browser.
 - If the user name and password of the administrator account have been set on the initial setting screen (➔ page 55) or on the [NETWORK] menu → [ADMINISTRATOR ACCOUNT] (➔ page 140) , proceed to Step 7).
 - The [Set up password] page is displayed if the administrator account has not been set.

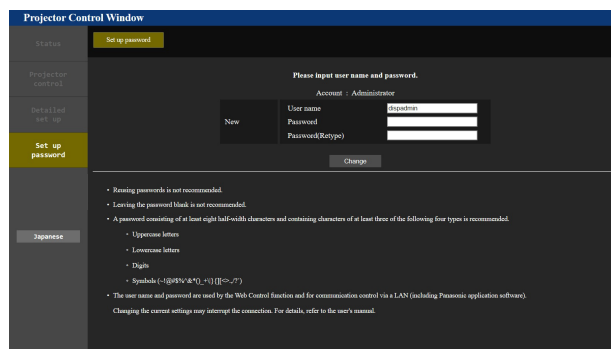

- 3) In [User name], enter the user name of the administrator account.
 - The factory default setting of user name is "dispadmin".
- 4) In [Password], enter the password of the administrator account.
 - The password cannot be blank.
 - A password consisting of at least eight single-byte characters is recommended.
 - A password consisting of at least three of the following four character types is recommended.
 - Uppercase letters

- Lowercase letters
- Digits
- Symbols (~!@#%\$%^&*()_+|\}][[<>./?'')

- 5) In [Password(Retype)], re-enter the password entered in Step 4).
- 6) Click [Change].
 - Setting of the administrator account is completed.
- 7) Enter the user name and password on the displayed login screen.

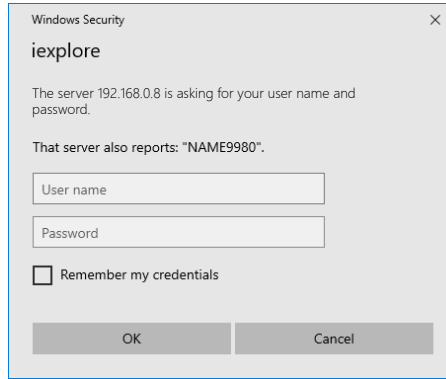

- Enter the user name and password of the administrator account, or the user name and password of a standard user account without administrator rights.

- 8) Click [OK].

Attention

- The entry screen for the user name and password may be hidden by other window that is already opened. In such case, minimize the window in front to display the entry screen.

Note

- The user name and password of the standard user account can be set on the [Set up password] page (➔ page 162) of the administrator account.
- If you use a web browser to control the projector, set the [NETWORK] menu → [NETWORK CONTROL] → [WEB CONTROL] to [ON].
- Do not perform setting or control simultaneously by starting up multiple web browsers. Do not set or control the projector from multiple computers.
- Access will be locked for few minutes when an incorrect password is entered three times consecutively.
- Some items on the projector setting page use the JavaScript function of the web browser. Correct control may not be possible when the web browser is set not to use this function.
- If the screen for the web control is not displayed, consult your network administrator.
- While updating the screen for the web control, the screen may appear white for a moment, but it is not a malfunction.
- Screenshot of a computer
The size or the display of the screen may be different from this manual depending on the OS or the Web browser, or the type of computer in use.

Rights for each account

The administrator account allows use of all functions. There is a limitation in the functions that can be used with the standard user account. Select the account depending on the purpose.

The function that has ✓ in the administrator / standard user column indicates that it can be operated with their respective accounts.

Item	Function	Administrator	Standard User	Page
[Status]	[Projector status]	✓	✓	153
	Error information page	✓	✓	154
	[Network status]	✓	✓	154
	[Access error log]	✓	—	154
	[Mail error log]	✓	—	155
[Projector control]	[Basic control]	✓	✓	155
	[Detail control]	✓	—	156

Item	Function	Administrator	Standard User	Page
[Detailed set up]	[Network config]	✓	—	156
	[Adjust clock]	✓	—	157
	[Ping test]	✓	—	158
	[Network security]	✓	—	158
	[E-mail set up]	✓	—	158
	[Authentication set up]	✓	—	159
	[ECO management set up]	✓	—	160
	[Crestron tools]	✓	—	162
[Set up password]	User name of [Administrator]	✓	—	162
	User name of [User]	✓	—	162
	Password of [Administrator]	✓	—	162
	Password of [User]	✓	✓	162, 164
	Password of [PJlink]	✓	—	163

Descriptions of items



- 1 **Page tab**
Switches pages by clicking this item.
- 2 **[Status]**
The status of the projector is displayed by clicking this item.
- 3 **[Projector control]**
The [Projector control] page is displayed by clicking this item.
- 4 **[Detailed set up]**
The [Detailed set up] page is displayed by clicking this item.
- 5 **[Set up password]**
The [Set up password] page is displayed by clicking this item.

[Projector status] page

Click [Status] → [Projector status].

Display the status of the projector for the following items.

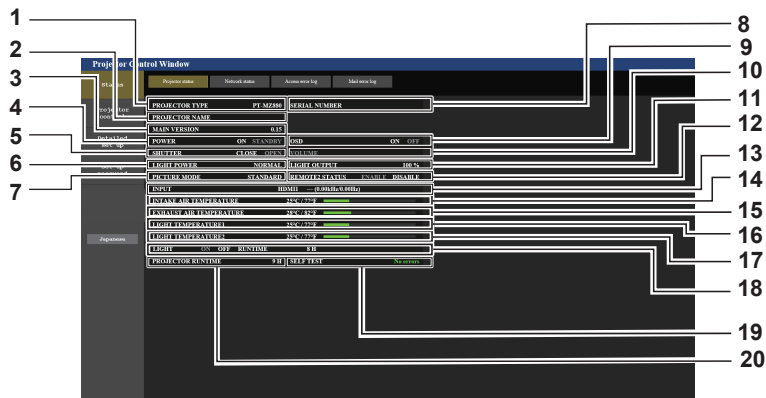

- 1 **[PROJECTOR TYPE]**
Displays the type of the projector.
- 2 **[PROJECTOR NAME]**
Displays the projector name set for the projector.
- 3 **[MAIN VERSION]**
Displays the main version of the firmware of the projector.
- 4 **[POWER]**
Displays the status of the power.
- 5 **[SHUTTER]**
Displays the status of the shutter. ([CLOSE]: Shutter function enabled; [OPEN]: Shutter function disabled)

- 6 **[LIGHT POWER]**
Displays the setting status of [LIGHT POWER].
- 7 **[PICTURE MODE]**
Displays the setting status of [PICTURE MODE].
- 8 **[SERIAL NUMBER]**
Displays the serial number of the projector.
- 9 **[OSD]**
Displays the status of the on-screen display.
- 10 **[VOLUME]**
Display the volume status.
- 11 **[LIGHT OUTPUT]**
Displays the setting status of [LIGHT OUTPUT].
- 12 **[REMOTE2 STATUS]**
Displays the control status of the <REMOTE 2 IN> terminal.
- 13 **[INPUT]**
Displays the status of the selected input.
- 14 **[INTAKE AIR TEMPERATURE]**
Displays the status of the intake air temperature of the projector.
- 15 **[EXHAUST AIR TEMPERATURE]**
Displays the status of the exhaust air temperature of the projector.
- 16 **[LIGHT TEMPERATURE1]**
Displays the temperature status of light source 1.
- 17 **[LIGHT TEMPERATURE2]**
(Only for PT-MZ880 and PT-MZ780)
Displays the temperature status of light source 2.
- 18 **[LIGHT]**
Displays the lighting status and runtime of the light source.
- 19 **[SELF TEST]**
Displays the self-diagnosis information.
- 20 **[PROJECTOR RUNTIME]**
Displays the runtime of the projector.

Error information page

When [Error (Detail)] or [Warning (Detail)] is displayed in the [SELF TEST] display field of the [Projector status] screen, click it to display the content of the error/warning.

- The projector may go into the standby status to protect the projector depending on the contents of the error.

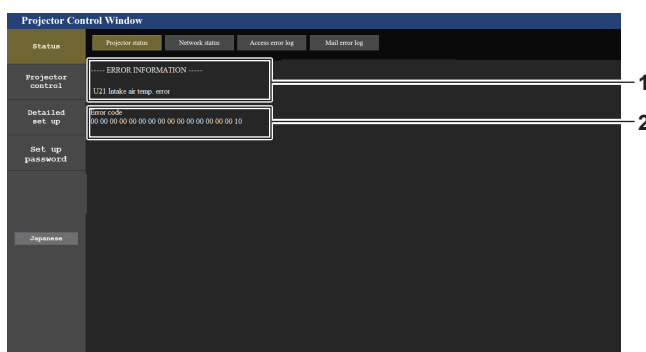

- 1 **Display of error information**
Displays the alphanumeric symbols and content of errors/warnings that occur.
For the details of the display content, refer to "[SELF TEST] display" (➔ page 183).

- 2 **Error code**

[Network status] page

Click [Status] → [Network status].
The current network setting status is displayed.

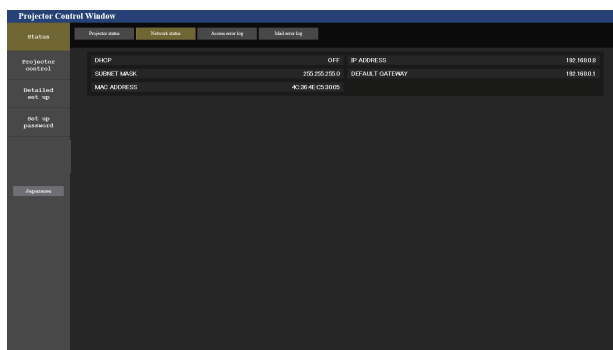

[Access error log] page

Click [Status] → [Access error log].
The error log on the web server is displayed such as access to the pages that do not exist or access with unauthorized user names or passwords.

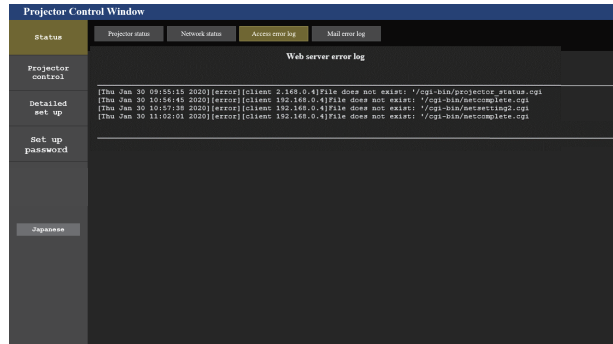

[Mail error log] page

Click [Status] → [Mail error log].

E-mail error log is displayed if periodic E-mail sending has failed.

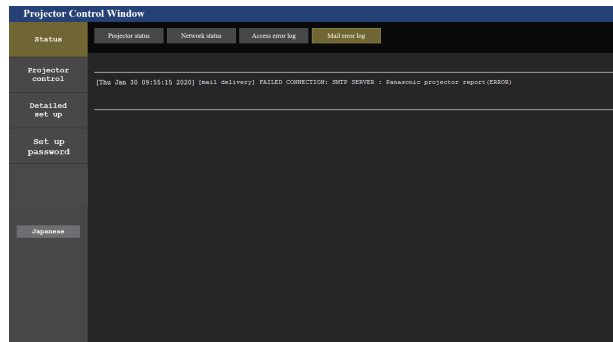

Note

- [Access error log] and [Mail error log] display the recent few thousand accesses/requests. All information may not be displayed when many accesses/requests are made at once.
- Logs in [Access error log] and [Mail error log] are deleted from the oldest when exceeding a certain amount.
- Check [Access error log] and [Mail error log] periodically.

[Basic control] page

Click [Projector control] → [Basic control].

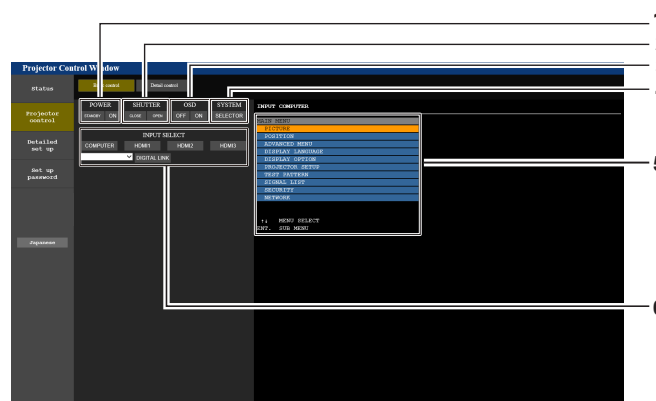

- [POWER]**
Turns off/on the power.
- [SHUTTER]**
Switches the status of the shutter. ([CLOSE]: Shutter function enabled; [OPEN]: Shutter function disabled)
- [OSD]**
Switches on (display)/off (hide) the on-screen display function.
- [SYSTEM]**
Switches the system method.
- On-screen display of the projector**
Displays the same items as shown on the on-screen display of the projector. You can check or change the settings of the menus. It is displayed even if the on-screen display function is set to off (hide).
- [INPUT SELECT]**
Switches the input signal.

[Detail control] page

Click [Projector control] → [Detail control].

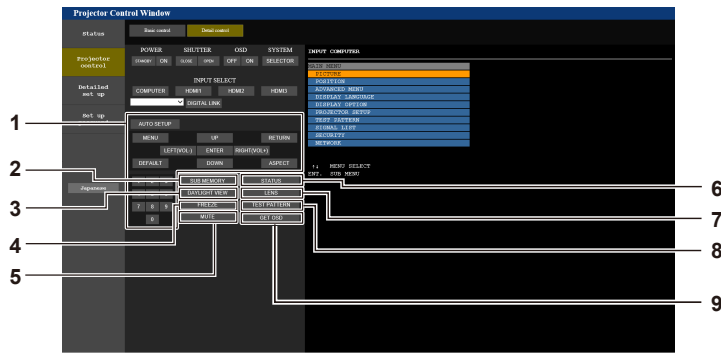

- | | |
|---|---|
| <p>1 Control of the projector
The projector is controlled by clicking the buttons in the same way as the buttons on the remote control. After control, the on-screen display of the projector at the right of the control page is updated.</p> <p>2 [SUB MEMORY]
Switches the sub memory.</p> <p>3 [DAYLIGHT VIEW]
Switches the day light view setting.</p> <p>4 [FREEZE]
Temporarily pauses the image.</p> | <p>5 [MUTE]
Switches whether to use the mute function.</p> <p>6 [STATUS]
The [STATUS] screen is displayed on the projected image.</p> <p>7 [LENS]
Displays the [LENS] page.</p> <p>8 [TEST PATTERN]
Displays the test pattern.</p> <p>9 [GET OSD]
Updates the on-screen display of the projector at the right of the control page.</p> |
|---|---|

[LENS] page

Click [Projector control] → [Detail control] → [LENS].

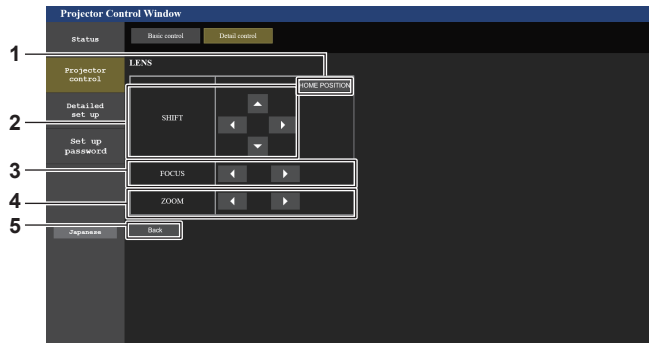

- | | |
|--|---|
| <p>1 [HOME POSITION]
Moves the projection lens to the home position.</p> <p>2 [SHIFT]
Click ▲▼◀▶ to adjust the lens shift (vertical position and horizontal position).
The adjustment can be performed faster by holding down the button for approximately three seconds or longer.</p> <p>3 [FOCUS]
Click ◀▶ to adjust the focus.
The adjustment can be performed faster by holding down the button for approximately three seconds or longer.</p> | <p>4 [ZOOM]
Click ◀▶ to adjust the zoom.
The adjustment can be performed faster by clicking and holding the button for approximately three seconds or longer.</p> <p>5 [Back]
Returns to the [Detail control] page.</p> |
|--|---|

[Network config] page

Click [Detailed set up] → [Network config].

- Click [Network config] to display the [CAUTION!] screen.
- Click the [Next] button to display the current settings.
- Click the [Change] button to display the setting change screen.

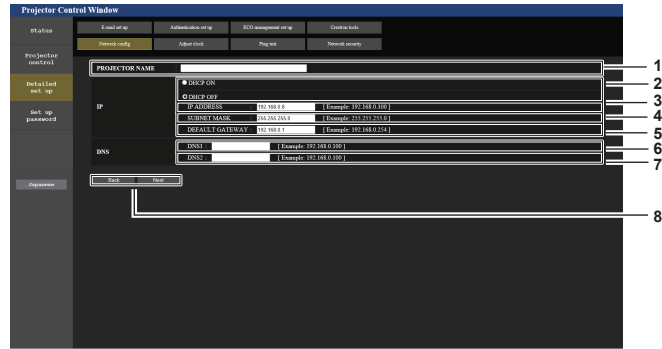

- 1 **[PROJECTOR NAME]**
Enter the name of the projector. Enter the host name if it is required when using a DHCP server etc.
- 2 **[DHCP ON], [DHCP OFF]**
To enable the DHCP client function, set to [DHCP ON].
- 3 **[IP ADDRESS]**
Enter the IP address when not using a DHCP server.
- 4 **[SUBNET MASK]**
Enter the subnet mask when not using a DHCP server.
- 5 **[DEFAULT GATEWAY]**
Enter the default gateway address when not using a DHCP server.
- 6 **[DNS1]**
Enter the DNS1 server address.
Permissible characters for the entry of DNS1 server address (primary):
Numbers (0 - 9), period (.)
(Example: 192.168.0.253)
- 7 **[DNS2]**
Enter the DNS2 server address.
Available characters for the entry of DNS2 server address (secondary):
Numbers (0 - 9), period (.)
(Example: 192.168.0.254)
- 8 **[Back], [Next]**
Click the [Back] button to return to the original screen. Click the [Next] button to display the setting confirmation screen. Click the [Submit] button to update the setting.

Note

- When you use the “Forward” and “Back” functions of your browser, a warning message “Page has Expired” may appear. In that case, click [Network config] again since the following operation will not be guaranteed.
- The connection may be disconnected when the LAN setting is changed while connected with LAN.

[Adjust clock] page

Click [Detailed set up] → [Adjust clock].

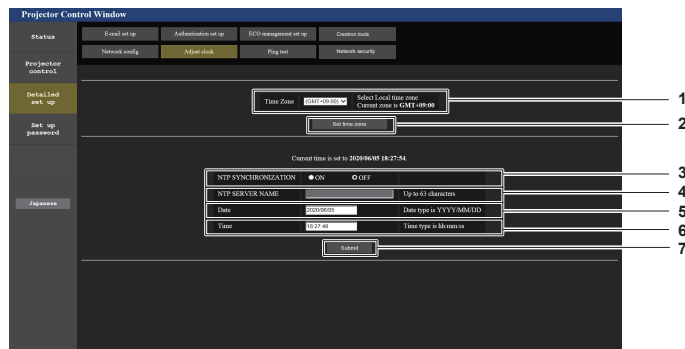

- 1 **[Time Zone]**
Select the time zone.
- 2 **[Set time zone]**
Updates the time zone setting.
- 3 **[NTP SYNCHRONIZATION]**
Set to [ON] when setting the date and time automatically.
- 4 **[NTP SERVER NAME]**
Enter the IP address or server name of the NTP server when you set to adjust the date and time manually.
(To enter the server name, the DNS server needs to be set up.)
- 5 **[Date]**
Enter the date to be changed.
- 6 **[Time]**
Enter the time to be changed.
- 7 **[Submit]**
Updates the date and time settings.

Note

- The replacement of the battery inside the projector is required when the time goes out of alignment right after correcting the time. Consult your dealer.

[Ping test] page

Check whether the network is connected to the E-mail server, POP server, DNS server, etc.
Click [Detailed set up] → [Ping test].

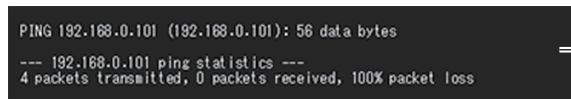
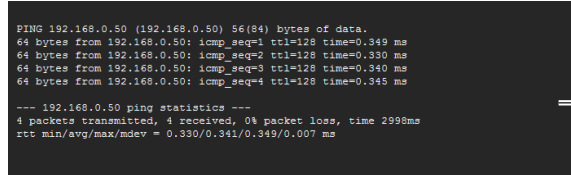
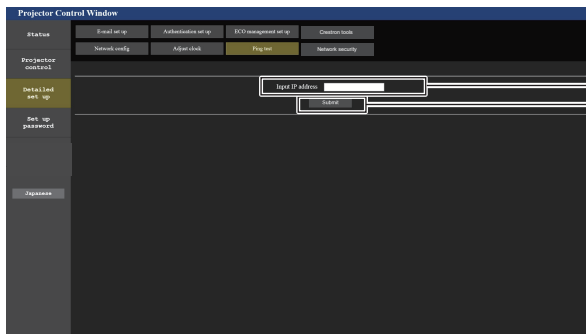

- [Input IP address]**
Enter the IP address of the server to be tested.
- [Submit]**
Executes the connection test.
- Example of display when the connection has succeeded**
- Example of display when the connection has failed**

[Network security] page

Make settings to protect the projector from external attacks via LAN and unauthorized use.
Click [Detailed set up] → [Network security].

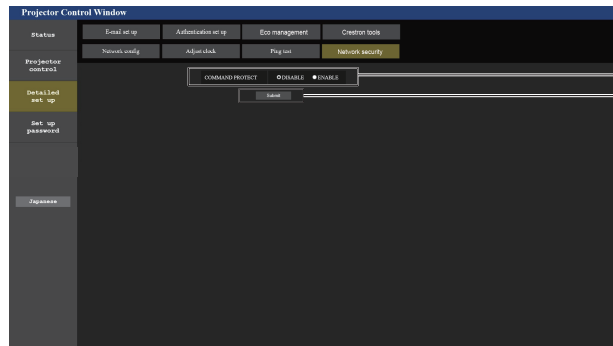

- [COMMAND PROTECT]**
Make settings for the connection authentication when using the command control function.
[DISABLE]: Connect to the projector in non-protected mode. Connection authentication is not performed.
[ENABLE]: Connect to the projector in protected mode. The user name and password of the administrator account are required for the connection authentication.
- [Submit]**
Updates the setting.
If you click [Submit] with [DISABLE] selected in [COMMAND PROTECT], a confirmation screen will be displayed. Click [OK] on the confirmation screen to update the settings.

Note

- When [COMMAND PROTECT] is set to [DISABLE], connection authentication is not performed, making it vulnerable to threats on the network. Be aware of the risks before making settings.
- For details on how to use the command control function, refer to "Control commands via LAN". (➔ page 191)

[E-mail set up] page

When there is a problem or the runtime of the light source reaches the preset value, an E-mail can be sent to previously set E-mail addresses (up to two addresses).
Click [Detailed set up] → [E-mail set up].

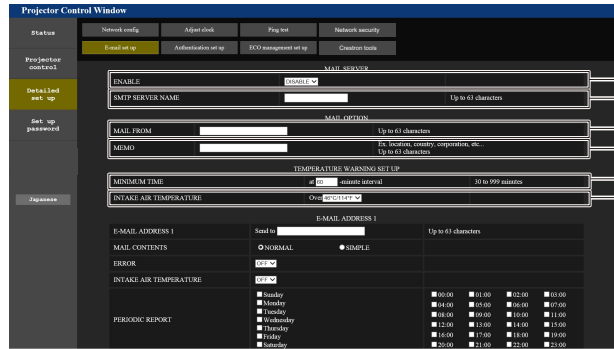

- 1 **[ENABLE]**
Select [Enable] to use the E-mail function.
- 2 **[SMTP SERVER NAME]**
Enter the IP address or the server name of the E-mail server (SMTP). To enter the server name, the DNS server needs to be set up.
- 3 **[MAIL FROM]**
Enter the E-mail address of the projector. (Up to 63 characters in single byte)
- 4 **[MEMO]**
Enter information such as the location of the projector that notifies the sender of the E-mail. (Up to 63 characters in single byte)

- 5 **[MINIMUM TIME]**
Change the minimum interval for the temperature warning E-mail. The default value is 60 minutes. In this case, another E-mail will not be sent for 60 minutes after sending the temperature warning E-mail even if it reaches the warning temperature.
- 6 **[INTAKE AIR TEMPERATURE]**
Change the temperature setting for the temperature warning mail. A temperature warning E-mail is sent when the temperature exceeds this value.

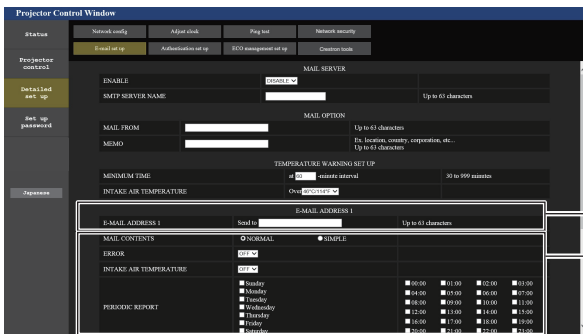

- 7 **[E-MAIL ADDRESS 1], [E-MAIL ADDRESS 2]**
Enter the E-mail address to be sent. Leave [E-MAIL ADDRESS 2] blank when two E-mail addresses are not to be used.
- 8 **Settings of the conditions to send E-mail**
Select the conditions to send E-mail.
[MAIL CONTENTS]:
Select either [NORMAL] or [SIMPLE].
[ERROR]:
Send an E-mail when an error occurred in the self-diagnosis.
[INTAKE AIR TEMPERATURE]:
Send an E-mail when the intake air temperature has reached the value set at the above field.

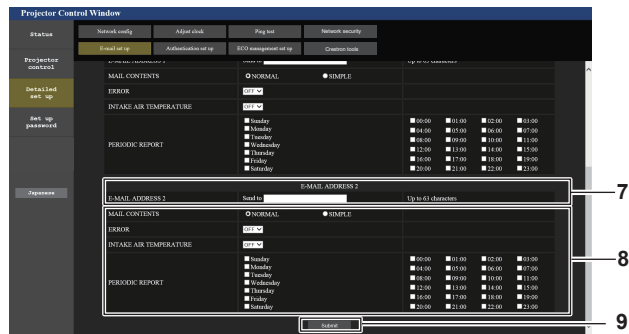

- [PERIODIC REPORT]:**
Place a check mark on this to send an E-mail periodically. It will be sent on the days and time with the check mark.
- 9 **[Submit]**
Update the settings.

[Authentication set up] page

Set the authentication items when POP authentication or SMTP authentication is necessary to send an E-mail. Click [Detailed set up] → [Authentication set up].

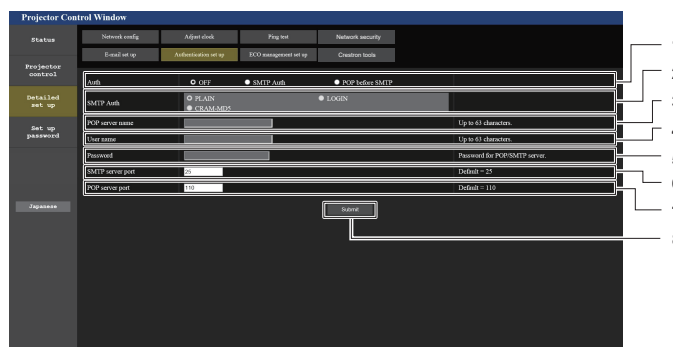

- 1 **[Auth]**
Select the authentication method specified by your Internet service provider.
- 2 **[SMTP Auth]**
Set when the SMTP authentication is selected.
- 3 **[POP server name]**
Enter the POP server name.
Allowed characters:
Alphanumerics (A - Z, a - z, 0 - 9)
Minus sign (-) and period (.)
- 4 **[User name]**
Enter the user name for the POP server or the SMTP server.
- 5 **[Password]**
Enter the password for the POP server or the SMTP server.
- 6 **[SMTP server port]**
Enter the port number of the SMTP server.
(Normally 25)
- 7 **[POP server port]**
Enter the port number of the POP server.
(Normally 110)
- 8 **[Submit]**
Update the settings.

[ECO management set up] page

Settings related to the ECO management function of the projector can be made.
Click [Detailed set up] → [ECO management set up].

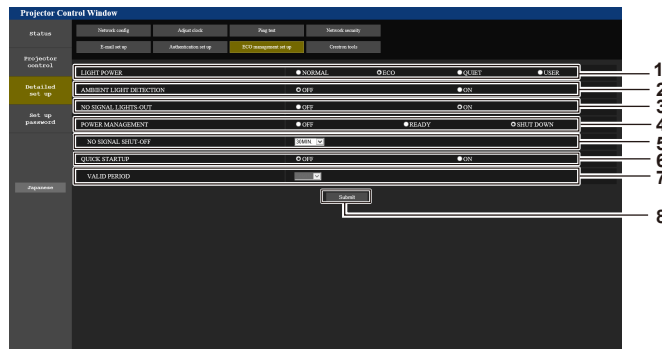

- 1 **[LIGHT POWER]**
Displays the [LIGHT POWER] setting.
- 2 **[AMBIENT LIGHT DETECTION]**
Enables ([ON])/disables ([OFF]) the ambient light detection function.
- 3 **[NO SIGNAL LIGHTS-OUT]**
Enables ([ON])/disables ([OFF]) the signal detection function.
- 4 **[POWER MANAGEMENT]**
Displays the [POWER MANAGEMENT] setting.
- 5 **[NO SIGNAL SHUT-OFF]**
Select the time until the light source is turned off after the power management function is operated.
- 6 **[QUICK STARTUP]**
Displays the [QUICK STARTUP] setting.
- 7 **[VALID PERIOD]**
Select the valid period until the [QUICK STARTUP] function is disabled after going into the standby mode.
- 8 **[Submit]**
Updates the setting.

Note

- For details of each setting item, refer to the [PROJECTOR SETUP] menu of the projector → [ECO MANAGEMENT].

Contents of E-mail sent

Example of the E-mail sent when E-mail is set

The following E-mail is sent when the E-mail settings have been established.

```

=== Panasonic projector report(CONFIGURE) ===
Projector Type      : PT-MZ880
Serial No          : 123456789012

----- E-mail setup data -----
TEMPERATURE WARNING SETUP
MINIMUM TIME       at [ 60] minutes interval
INTAKE AIR TEMPERATURE Over [ 46 degC / 114 degF ]

ERROR              [ ON ]
INTAKE AIR TEMPERATURE [ OFF ]
PERIODIC REPORT
Sunday [ OFF ] Monday [ OFF ] Tuesday [ OFF ] Wednesday [ OFF ]
Thursday [ OFF ] Friday [ ON ] Saturday [ OFF ]

00:00 [ OFF ] 01:00 [ OFF ] 02:00 [ OFF ] 03:00 [ OFF ]
04:00 [ OFF ] 05:00 [ OFF ] 06:00 [ OFF ] 07:00 [ OFF ]
08:00 [ OFF ] 09:00 [ OFF ] 10:00 [ OFF ] 11:00 [ OFF ]
12:00 [ OFF ] 13:00 [ OFF ] 14:00 [ OFF ] 15:00 [ OFF ]
16:00 [ ON ] 17:00 [ OFF ] 18:00 [ OFF ] 19:00 [ OFF ]
20:00 [ OFF ] 21:00 [ OFF ] 22:00 [ OFF ] 23:00 [ OFF ]

----- Error information -----

Error code :
00 00 00 00 00 00 00 00 00 00 00 00 00 00 00 00

Intake air temperature : 24 degC / 75 degF
Exhaust air temperature : 31 degC / 87 degF
Light temperature1     : 25 degC / 77 degF
Light temperature2     : 25 degC / 77 degF
PROJECTOR RUNTIME      7 H
POWER ON                16 times
LIGHT RUNTIME          7 H
LIGHT ON               16 times

----- Current status -----
MAIN VERSION 0.16
SUB VERSION 0.08
LIGHT STATUS LIGHT=OFF
INPUT HDMI3
REMOTE2 STATUS DISABLE

----- Wired Network configuration -----
DHCP Client OFF
IP address 192.168.0.8
MAC address 68:CF:1C:17:1B:43

Fri Jan 22 16:28:55 2021

----- Memo -----

```

Example of the E-mail sent for an error

The following E-mail is sent when an error has occurred.

```

=== Panasonic projector report(ERROR) ===
Projector Type      : PT-MZ880
Serial No          : 123456789012

----- Error information -----
H11 Intake air temp. sensor error

Error code :
00 00 00 00 00 00 00 00 00 00 01 00 00 00 00

Intake air temperature :-100 degC / -148 degF
Exhaust air temperature : 32 degC / 89 degF
Light temperature1     : 25 degC / 77 degF
Light temperature2     : 25 degC / 77 degF
PROJECTOR RUNTIME      6 H
POWER ON                15 times
LIGHT RUNTIME          6 H
LIGHT ON               15 times

----- Current status -----
MAIN VERSION 0.16
SUB VERSION 0.08
LIGHT STATUS LIGHT=OFF
INPUT HDMI3
REMOTE2 STATUS DISABLE

----- Wired Network configuration -----
DHCP Client OFF
IP address 192.168.0.8
MAC address 68:CF:1C:17:1B:43

Fri Jan 22 15:40:56 2021

----- Memo -----

```

[Crestron tools] page

Set the information required to connect the Crestron control system to the projector.
Click [Detailed set up] → [Crestron tools].

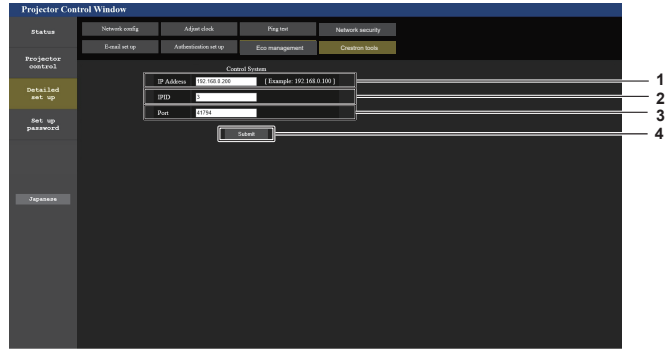

- | | |
|---|--|
| <p>1 [IP Address]
Set the IP address of the control system.</p> <p>2 [IPID]
Set the IPID of the control system.</p> | <p>3 [Port]
Set the port number of the control system.</p> <p>4 [Submit]
Update the setting.</p> |
|---|--|

[Set up password] page (for administrator account)

Click [Set up password].

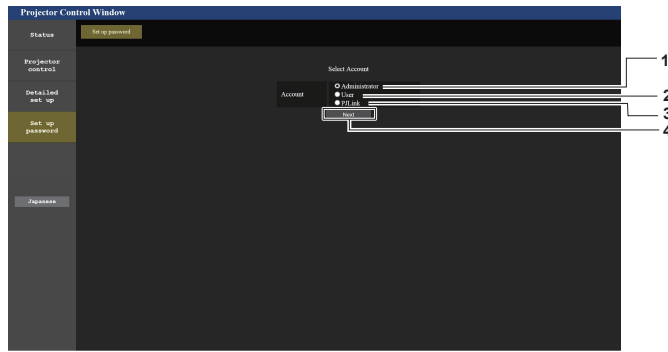

- | | |
|--|---|
| <p>1 [Administrator]
Used to change the setting of the administrator account.</p> <p>2 [User]
Used to change the setting of the standard user account.</p> | <p>3 [PjLink]
Used to change the setting of the PjLink account.</p> <p>4 [Next]
Used to change the setting of the password.</p> |
|--|---|

[Administrator]

The user name and password of the administrator account can be set.

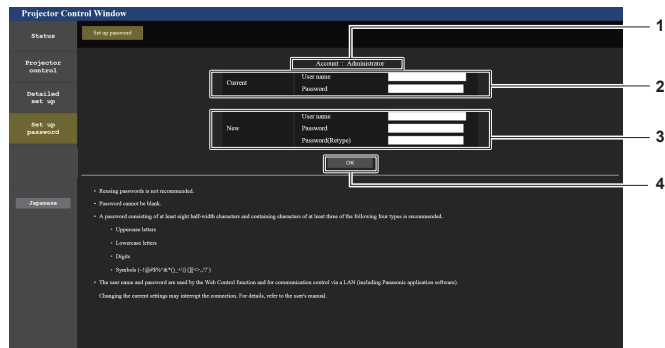

- 1 **[Account]**
Displays the account to change.
- 2 **[Current]**
[User name]:
Enter the current user name.
[Password]:
Enter the current password.
- 3 **[New]**
[User name]:
Enter the desired new user name. (Up to 16 characters in single byte)
[Password]:
Enter the desired new password. (Up to 16 characters in single byte)
[Password(Retype)]:
Enter the desired new password again.
- 4 **[OK]**
Determines the change of password.

Note

- When the projector is already registered in application software (such as “Multi Monitoring & Control Software”) which uses the communication control via LAN, communication with the projector will become impossible if the user name or password for [Administrator] is changed. If the user name or password for [Administrator] is changed, update the registration information of the application software in use.

[User]

The user name and password of the standard user account can be set.

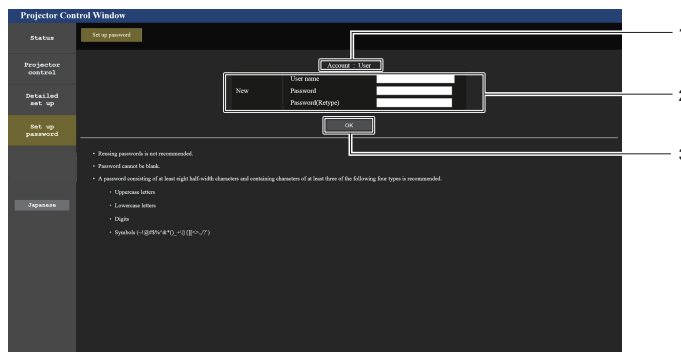

- 1 **[Account]**
Displays the account to change.
- 2 **[New]**
[User name]:
Enter the desired new user name. (Up to 16 characters in single byte)
[Password]:
Enter the desired new password. (Up to 16 characters in single byte)
[Password(Retype)]:
Enter the desired new password again.
- 3 **[OK]**
Determines the change of password.

[PJLink]

The password of the PJLink account can be changed.

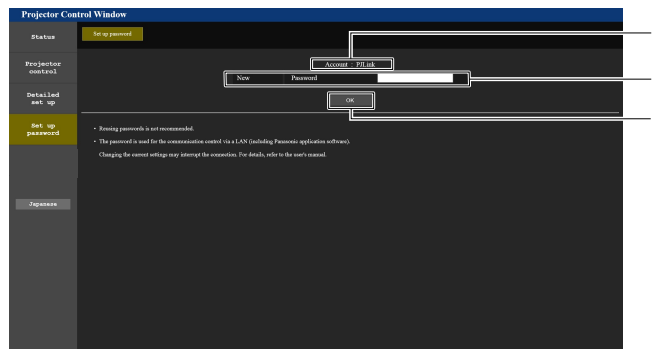

- 1 **[Account]**
Displays the account to change.
- 2 **[New]**
[Password]:
Enter the desired new password. (Up to 32 characters in single byte)
- 3 **[OK]**
Determines the change of password.

[Set up password] (for standard user account)

The password of the standard user account can be changed.

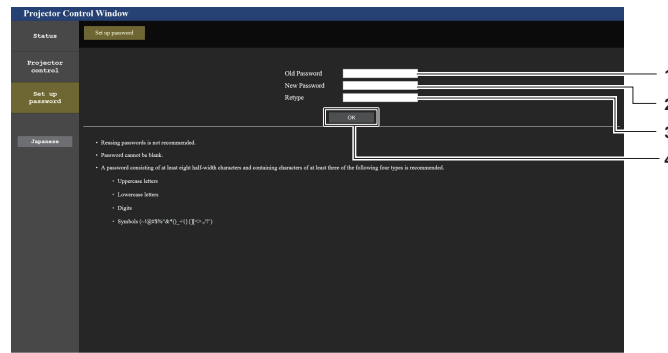

1 [Old Password]
Enter the current password.

2 [New Password]
Enter the desired new password. (Up to 16 characters in single byte)

3 [Retype]
Enter the desired new password again.

4 [OK]
Determines the change of password.

Using the data cloning function

Operate the data cloning function. The setting and adjustment values of one projector can be copied to multiple projectors via LAN.

■ Data that cannot be copied

Following settings can not be copied. Set these in each projector.

- The [DISPLAY OPTION] menu → [UNIFORMITY]
- The [PROJECTOR SETUP] menu → [PROJECTOR ID]
- The [PROJECTOR SETUP] menu → [DATE AND TIME] → [ADJUST CLOCK]
- The [PROJECTOR SETUP] menu → [DATA CLONING] → [WRITE PROTECT]
- The [SECURITY] menu → [MENU LOCK]
- The [SECURITY] menu → [SECURITY PASSWORD]
- The [SECURITY] menu → [CONTROL DEVICE SETUP]
- The [NETWORK] menu → [WIRED LAN]
- The [NETWORK] menu → [PROJECTOR NAME]
- The [NETWORK] menu → [ADMINISTRATOR ACCOUNT]
- The [NETWORK] menu → [NETWORK SECURITY] → [COMMAND PROTECT]
- The [NETWORK] menu → [PJLink] → [PJLink PASSWORD]
- Security password
- Menu lock password
- Operation setting password
- “[Network security] page” (➡ page 158) in the web control screen
- “[E-mail set up] page” (➡ page 158) in the web control screen
- “[Authentication set up] page” (➡ page 159) in the web control screen
- “[Crestron tools] page” (➡ page 162) in the web control screen
- Password set in “[Set up password] page” (➡ page 162) of the web control screen

Note

- The data cloning function will not operate when the models of the projectors are different. For example, data of PT-MZ880 can be copied to other PT-MZ880 projectors, but it can not be copied to PT-MZ780. Data cloning is limited to the same model.

Copying the data to other projector via LAN

Make the following settings on the projector as the data copy destination in advance. For details, refer to "Setting [WRITE PROTECT]". (➡ page 166)

- The [PROJECTOR SETUP] menu → [DATA CLONING] → [WRITE PROTECT] → [OFF]

Note

- To use the network function with the projector, it is necessary to set the password of the administrator account. (➡ page 140)
When a password is not set for the administrator account (when blank), the network function of the projector cannot be used. To copy the data via LAN, set the passwords for the copy source projector and the copy destination projector.

- 1) **Connect all projectors to the switching hub using LAN cables.** (➡ page 148)
- 2) **Turn on all the projectors.**
- 3) **On the copy source projector, press ▲▼ to select [DATA CLONING].**
- 4) **Press the <ENTER> button.**
 - The [SECURITY PASSWORD] screen is displayed.
- 5) **Enter a security password and press the <ENTER> button.**
 - The [DATA CLONING] screen is displayed.
- 6) **Press ▲▼ to select [SELECT PROJECTOR].**
- 7) **Press the <ENTER> button.**
 - The projector in the same subnet is displayed as a list.
- 8) **Press ▲▼ to select the copy destination projector.**

- 9) **Press the <ENTER> button.**
 - To select multiple projectors, repeat Steps 8) to 9).
- 10) **Press the <DEFAULT> button on the remote control.**
 - The confirmation screen is displayed.
- 11) **Press ◀▶ to select [OK], and press the <ENTER> button.**
 - Copy of the data between the projectors is started.
Once the copy is completed, the cloning result is displayed as a list in the **[DATA CLONING]** screen. Meanings of the marks displayed in the list are as follows.
 - Green: Data copy has succeeded.
 - Red: Data copy has failed. Confirm the connection of the LAN cable and power status of the copy destination projector.
 - Data is copied to the copy destination projector in the standby mode.
If the copy destination projector is in the projection mode, the data cloning request message is displayed, and then the copy destination projector automatically shifts to the standby mode to start copy of data.
- 12) **Turn on the power of the copy destination projector.**
 - The copied content is reflected on the copy destination projector.

Note

- The security password is the password set in the [SECURITY] menu → [SECURITY PASSWORD CHANGE].
Initial password as the factory default: ▲▶▼◀▲▶▼◀
- While data is being copied, the light source indicator <LIGHT>, the temperature indicator <TEMP>, and the filter indicator <FILTER> of the destination projector will blink. Make sure that the indicators stop blinking before powering on the projector.

Setting [WRITE PROTECT]

Set if the copy of data using the data cloning function is permitted or not.

- 1) **On the copy destination projector, press ▲▼ to select [DATA CLONING].**
- 2) **Press the <ENTER> button.**
 - The [SECURITY PASSWORD] screen is displayed.
- 3) **Enter a security password and press the <ENTER> button.**
 - The [DATA CLONING] screen is displayed.
- 4) **Press ▲▼ to select [WRITE PROTECT].**
- 5) **Press ◀▶ to switch the item.**
 - The items will switch each time you press the button.

[OFF]	Permits operations of the data cloning function from another projector.
[ON]	Does not permit the operations of the data cloning function from another projector. <ul style="list-style-type: none"> • Data copy will not be possible when [ON] is set. When it is not necessary to copy data of another projector, set to [ON] so that the data is not changed by mistake.

Note

- The security password is the password set in the [SECURITY] menu → [SECURITY PASSWORD CHANGE].
Initial password as the factory default: ▲▶▼◀▲▶▼◀

Using HDMI-CEC function

HDMI-CEC function allows the basic operation of CEC-compatible device with the projector remote control or the link control between the projector and CEC-compatible device.

Connecting a CEC-compatible device

Connect a CEC-compatible device to the <HDMI IN 1> terminal, <HDMI IN 2> terminal or <HDMI IN 3> terminal.

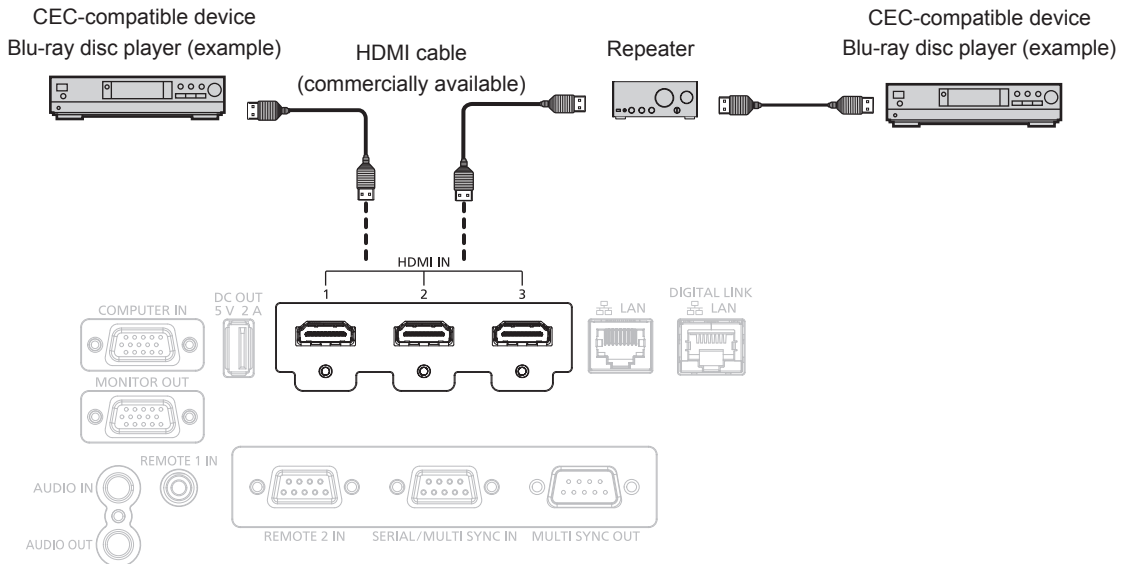

Connection example with CEC-compatible device

Setting the projector and CEC-compatible device

Before using the HDMI-CEC function, you need to configure the settings on the projector and the CEC-compatible device.

- CEC-compatible device: enable the HDMI-CEC function.
- Projector: Set the [PROJECTOR SETUP] menu → [HDMI CEC] to [ON]. (➔ page 126)

Note

- After switching on the CEC-compatible device, switch on the projector and select HDMI1 input, HDMI2 input or HDMI3 input, then check that the image from the CEC-compatible device is projected correctly.
- While performing contact control using the <REMOTE 2 IN> terminal, the [HDMI CEC] menu is fixed to [OFF] and the CEC function is disabled.

Operating the CEC-compatible device with the projector remote control

You can operate the device using the projector remote control by calling up the operation menu of the CEC-compatible device from the HDMI-CEC operation screen. Use the number buttons (<2>, <5>, <8>) on the remote control to select the operation item on the HDMI-CEC operation screen.

About the HDMI-CEC operation screen, refer to "Operating a CEC-compatible device" (➔ page 126).

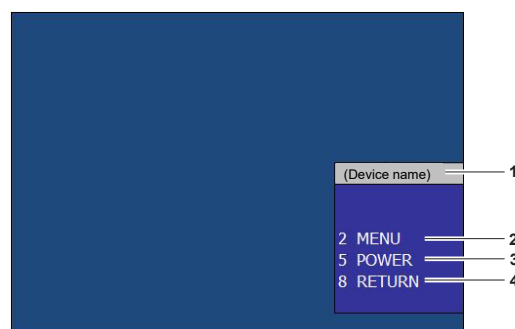

HDMI-CEC operation screen

- | | |
|--|--|
| <p>1 Displays the device name to be operated.</p> <p>2 [MENU]
Call up the operation menu of the CEC-compatible device.</p> | <p>3 [POWER]
Switch on/off the device.</p> <p>4 [RETURN]
Returns the operation menu of the CEC-compatible device to the previous screen.</p> |
|--|--|

Note

- If the operation menu of the CEC-compatible device cannot be called up from the HDMI-CEC operation screen, change the menu code setting. For the operation details, refer to "Changing the menu code" (▶ page 127).
- If you cannot operate the operation menu of a CEC-compatible device, try setting the [PROJECTOR SETUP] menu → [HDMI CEC] to [OFF] and [ON] again. It may be improved.
- While the HDMI-CEC operation screen is displayed, only the number buttons on the remote control can be used and other button operations are disabled.

Menu operation of CEC-compatible device

When the setting menu of the CEC-compatible device is displayed, you can use the ▲▼◀▶ buttons and <ENTER> button of the remote control to operate the menu.

About the link control

By setting the [PROJECTOR SETUP] menu → [HDMI CEC] → [PROJECTOR -> DEVICE] / [DEVICE -> PROJECTOR] to a setting other than [DISABLE], the following link operations can be achieved.

The link control setting of [PROJECTOR -> DEVICE]

■ When the setting is [POWER OFF] or [POWER ON / OFF]

- If the projector is switched off, all connected CEC-compatible devices are switched off.

■ When the setting is [POWER ON / OFF]

- If the input channel is HDMI1, HDMI2 or HDMI3 when the projector is switched on and starts projection, then the CEC-compatible devices connected to the <HDMI IN 1> terminal, <HDMI IN 2> terminal or <HDMI IN 3> terminal are switched on upon startup of the projector.

The link control setting of [DEVICE -> PROJECTOR]

■ When the setting is [POWER ON] or [POWER ON / OFF]

- While the projector is in standby, if the CEC-compatible device is turned on, the projector turns on and switches to the input that the CEC-compatible device is connected.
- While the projector is in standby, if the CEC-compatible device starts playing, the projector turns on and switches to the input that the CEC-compatible device is connected.
- While the projector is turned on, if the CEC-compatible device starts playing, the projector switches to the input that the CEC-compatible device is connected.

■ When the setting is [POWER ON / OFF]

- When the CEC-compatible device connected to the selected input (HDMI1, HDMI2 or HDMI3) is switched off, the projector enters standby mode.

Note

- Depending on the status of the device, such as when the projector or the CEC-compatible device is starting up, the link control may not operate normally.
- If the CEC-compatible device does not support CEC 1.4, it may not support the link control described in the manual.

Updating the firmware

The firmware of the projector can be updated via LAN.

Check the website (<https://panasonic.net/cns/projector/pass/>) for availability of the firmware that can be updated. Customer can update the firmware if a newer version than the current firmware version is published.

It is necessary to register and log in to PASS*¹ to confirm the availability of the firmware that can be updated or to download the firmware.

*1 PASS: Panasonic Professional Display and Projector Technical Support Website
For details, visit the website (<https://panasonic.net/cns/projector/pass/>).

■ Firmware that can be updated

Main version

■ How to confirm the firmware version

Current firmware version can be confirmed by pressing the <STATUS> button on the remote control and displaying the [STATUS] screen.

The firmware version can also be confirmed in the [PROJECTOR SETUP] menu → [STATUS].

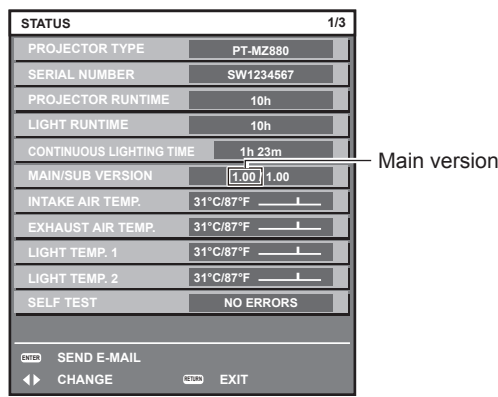

Note

- A LAN cable is required to connect to the network via wired LAN.

Updating the firmware via LAN

Example of network connection

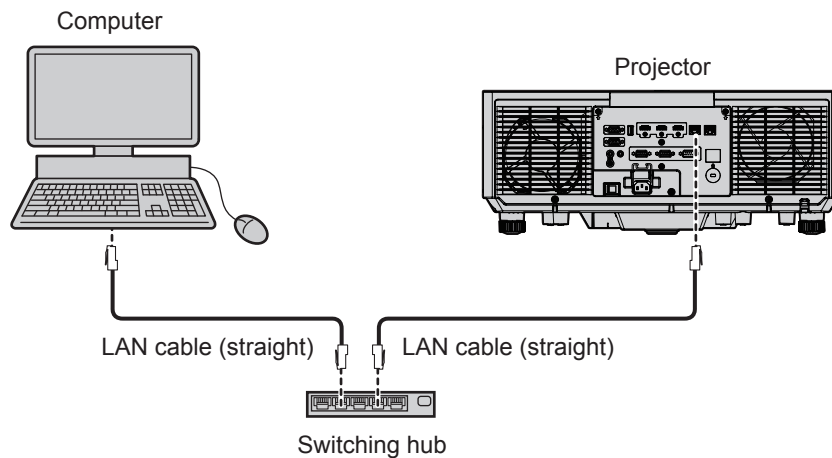

Attention

- When a LAN cable is directly connected to the projector, the network connection must be made indoors.

Note

- A LAN cable is required to connect to the network via wired LAN.
- Connect a LAN cable to the <LAN> terminal or the <DIGITAL LINK/LAN> terminal of the projector.

- To connect to the network using the <LAN> terminal, set the [NETWORK] menu → [ETHERNET TYPE] to [LAN] or [LAN & DIGITAL LINK].
- To connect to the network using the <DIGITAL LINK/LAN> terminal, set the [NETWORK] menu → [ETHERNET TYPE] to [DIGITAL LINK] or [LAN & DIGITAL LINK].
- The <DIGITAL LINK/LAN> terminal and the <LAN> terminal are connected inside of the projector when the [NETWORK] menu → [ETHERNET TYPE] is set to [LAN & DIGITAL LINK]. Do not directly connect the <DIGITAL LINK/LAN> terminal and the <LAN> terminal using a LAN cable. Construct the system so that it is not connected to the same network via the peripherals such as the switching hub or the twisted-pair-cable transmitter.
- Use a straight or crossover LAN cable that is compatible with CAT5 or higher for the LAN cable to connect to the <LAN> terminal. Either the straight or the crossover cable, or both cables can be used depending on the system configuration. Consult your network administrator. The projector will determine the type of the cable (straight or crossover) automatically.
- Use a LAN cable of 100 m (328'1") or shorter as the LAN cable to connect to the <LAN> terminal.
- For the LAN cable between the twisted-pair-cable transmitter and the projector, use a cable that meets the following criteria:
 - Conforming to CAT5e or higher standards
 - Shielded type (including connectors)
 - Straight-through
 - Single wire
 - Diameter of the cable core is same or larger than AWG24 (AWG24, AWG23, etc.)
- The maximum transmission distance between the twisted-pair-cable transmitter and the projector is normally 100 m (328'1"). It is possible to transmit up to 150 m (492'2") if the twisted-pair-cable transmitter supports the long-reach communication method.
- Do not use a switching hub between the twisted-pair-cable transmitter and the projector.

Computer used for updating the firmware

Prepare a computer compatible with the following OS and equipped with a LAN terminal.

- Microsoft Windows 10
 - Windows 10 Pro 32 bit/64 bit, Windows 10 32 bit/64 bit
- Microsoft Windows 8.1
 - Windows 8.1 Pro 32 bit/64 bit, Windows 8.1 32 bit/64 bit

Note

- The operation is not guaranteed when used in an environment outside the conditions described in this section, or when a home-made computer is used.
- This does not guarantee the operation on all computers even if it is used in the environment fulfilling the conditions described in this section.
- Connection with the projector or the data transfer of the firmware may fail in following cases. If it has failed, change the software setting or change the [Power Options] setting in Windows OS, and try the update again.
 - When security software such as firewall or the utility software for the LAN adapter is installed
 - When other software has started up or operating
 - When the computer has gone into sleep/pause status

Acquiring the firmware

Download the firmware update tool for this projector (compressed file in zip format) from the website (<https://panasonic.net/cns/projector/pass/>).

- File name (example): FirmUpdateTool_MZ880_101.zip
(Update tool for the PT-MZ880/PT-MZ780/PT-MZ680 with main version 1.01)

Confirming the setting of the projector

Confirm the setting of the projector to be updated in advance.

- Whether the [PROJECTOR SETUP] menu → [ECO MANAGEMENT] → [STANDBY MODE] is set to [NORMAL]
- The [NETWORK] menu → [NETWORK CONTROL] → [COMMAND PORT]
- The [NETWORK] menu → [NETWORK STATUS]
 - [DHCP]
 - [IP ADDRESS]
 - [SUBNET MASK]
 - [DEFAULT GATEWAY]
- User name and password of the administrator account

Confirming the computer setting

Confirm the network setting of the computer to be used for update, and make it possible to connect with the projector to be updated via network.

Updating the firmware

- 1) Extract the compressed file downloaded from the website.

- The firmware update tool (executable file in exe format) is generated.
File name (example): FirmUpdateTool_MZ880_101.exe

2) Double-click the executable file generated by extracting.

- The update tool is started up, and the confirmation screen is displayed.

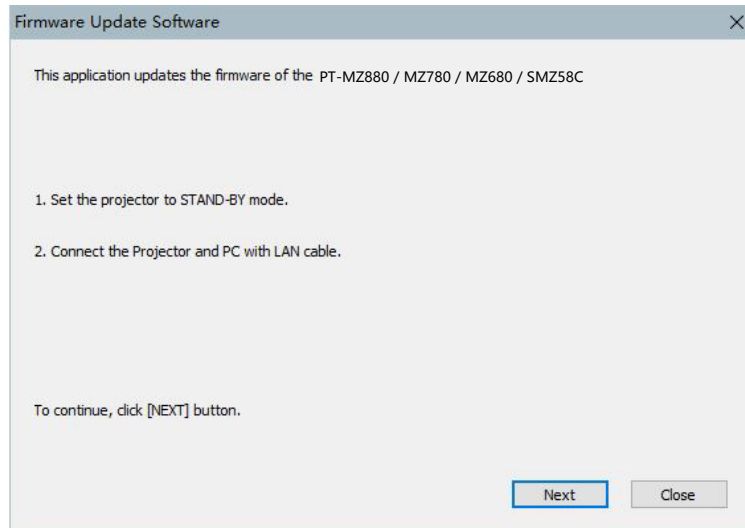

3) Confirm the status of the projector.

- Confirm that the projector to be updated is in the standby mode.

4) Confirm the connection status.

- Confirm that the projector to be updated and the computer to be used for update are correctly connected via LAN.

5) Click [Next].

- The license agreement screen is displayed.
- Confirm the content of the license agreement.

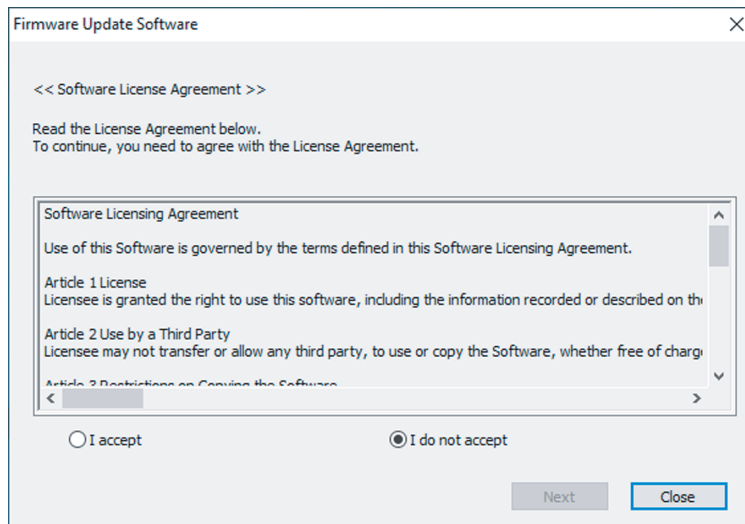

- The update tool will end by clicking [Close].

6) Select [I accept].

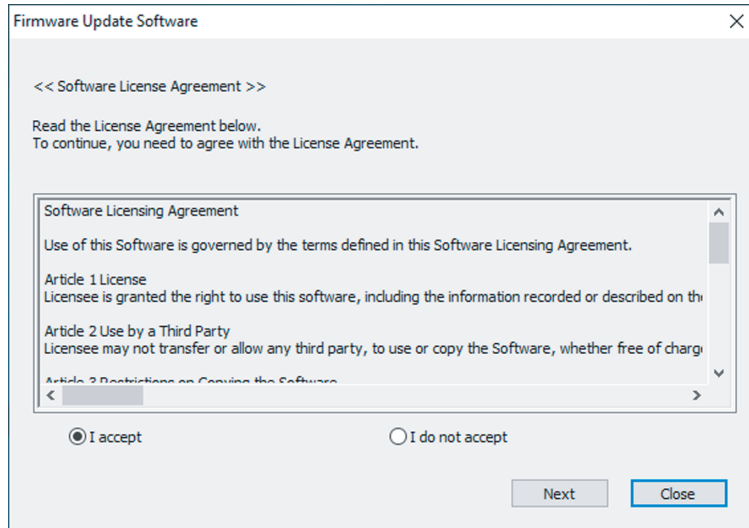

7) Click [Next].

- The connection setting screen is displayed.

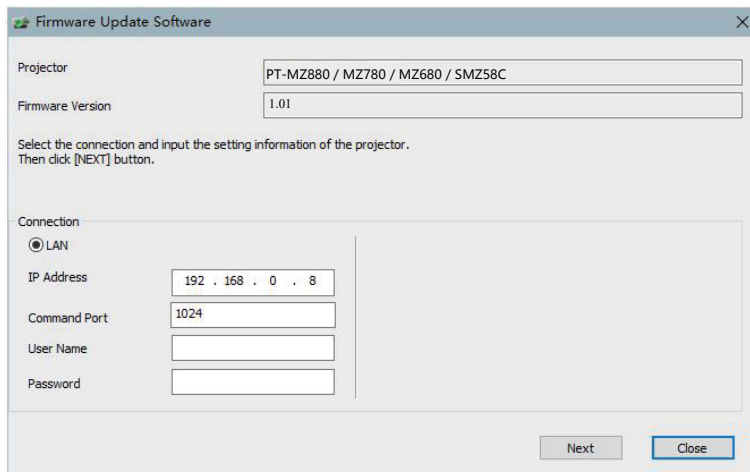

8) Enter the setting details of the projector.

- Enter the details set in the projector to be updated.

Item	Details
[IP Address]	The [NETWORK] menu → [NETWORK STATUS] → [IP ADDRESS]
[Command Port]	The [NETWORK] menu → [NETWORK CONTROL] → [COMMAND PORT]
[User Name]	The user name of the administrator account
[Password]	The password of the administrator account

9) Click [Next].

- The update confirmation screen is displayed.

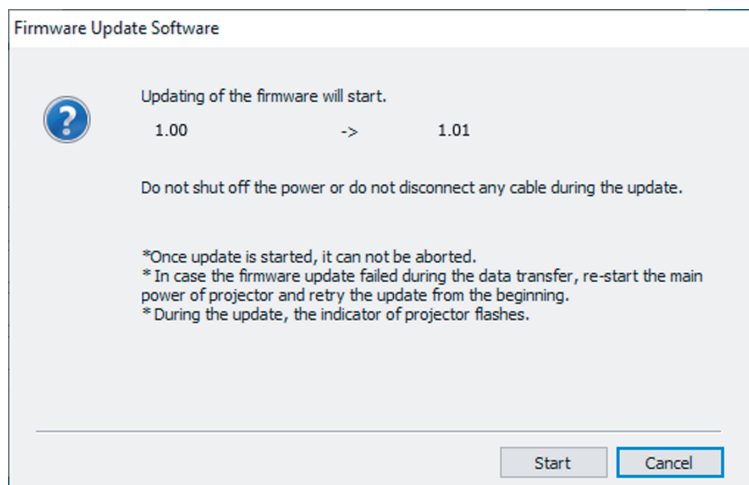

10) Click [Start].

- Update is started.
- The temperature indicator <TEMP> and the light source indicator <LIGHT> on the projector blink red alternately while updating.
- Elapsed time and rough progress can be confirmed in the update status display screen. The required time is approximately 15 minutes.

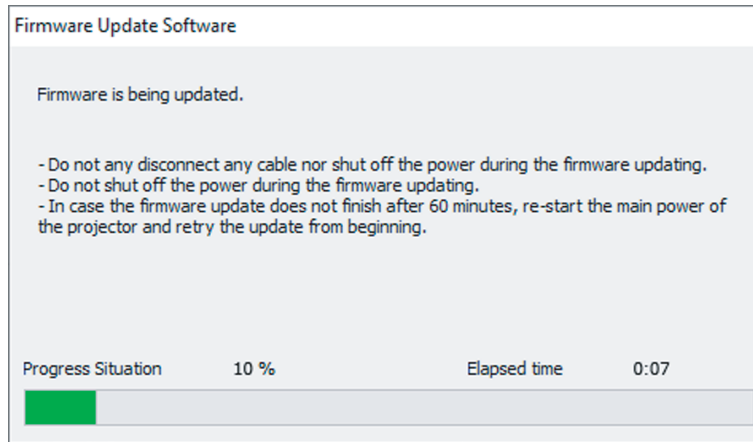

11) Confirm the completion of the update.

- Once the update is completed, the completion confirmation screen is displayed.

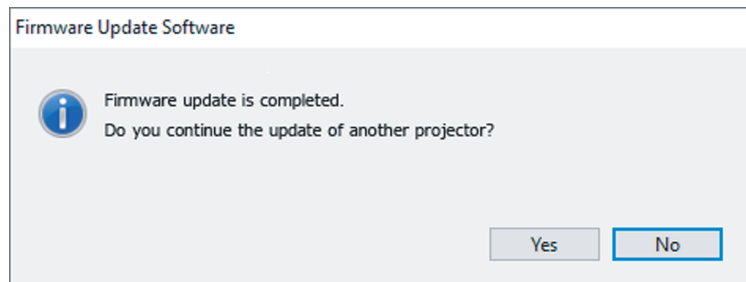

- To continue to update the firmware of another projector, click [Yes]. The connection setting screen in Step 7) is displayed.
- To end the update tool, click [No].

12) Confirm the firmware version.

- Turn on the power of the projector and confirm the firmware version in the [STATUS] screen.

Attention

- Do not disconnect the main power of the projector or disconnect the LAN cable while updating.

Note

- In following cases, turn the power of the projector off and on and perform the update from the beginning.
 - When the update does not complete after 60 minutes or more have elapsed
 - When the power of the projector or the computer has turned off due to power outage, etc., during the update

Chapter 6 Maintenance

This chapter describes methods of inspection when there are problems, maintenance, and replacement of the units.

Light source/temperature/filter indicators

When an indicator lights up

If a problem occurs inside the projector, the light source indicator <LIGHT>/temperature indicator <TEMP>/filter indicator <FILTER> will inform you by illuminating or blinking. Check the status of the indicators and take following measures.

Attention

- When switching off the projector to deal with problems, make sure to follow the procedure in “Switching off the projector” (➔ page 61).

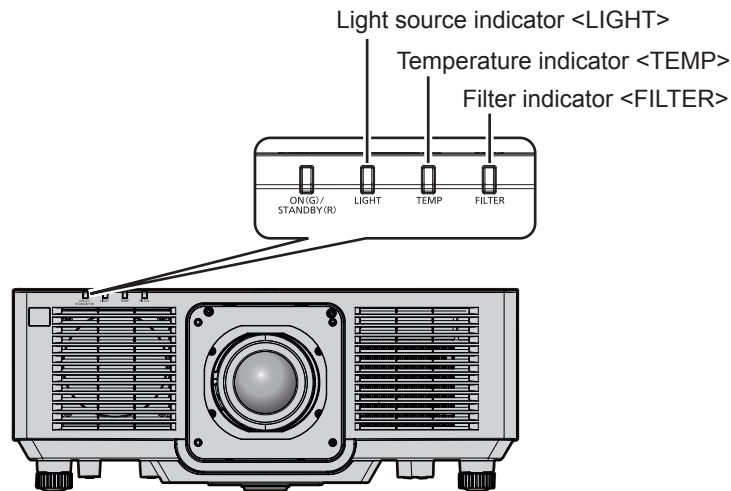

Light source indicator <LIGHT>

Indicator status	Lighting red	Blinking red (2 times)	Blinking red (3 times)
Status	Some of the elements of the light source are defective and the light output has decreased.	The light source does not light up, or the light source turns off while the projector is in use.	
Solution	<ul style="list-style-type: none"> Turn the <MAIN POWER> switch to <OFF> (➔ page 61), and turn on the power again. 		

Note

- If the light source indicator <LIGHT> continues to light or blink even after the measure is taken, set the <MAIN POWER> switch to <OFF>, and ask your dealer for repair.

Temperature indicator <TEMP>

Indicator status	Lighting red	Blinking red (2 times)	Blinking red (3 times)
Status	Internal temperature is high (warning).	Internal temperature is high (standby status).	The cooling fan has stopped.
Cause	<ul style="list-style-type: none"> Is the intake/exhaust vent blocked? Is the room temperature high? 		—
Solution	<ul style="list-style-type: none"> Remove any objects that are blocking the intake/exhaust vent. Install the projector in a location with the operating environment temperature between 0 °C (32 °F) and 45 °C (113 °F). Do not use the projector at high altitudes of 2 700 m (8 858') or higher above sea level. 		<ul style="list-style-type: none"> Turn the <MAIN POWER> switch to <OFF> (➔ page 61), and consult your dealer.

Note

- If the temperature indicator <TEMP> is still lit or blinking after taking the measures, ask your dealer for repair.

Filter indicator <FILTER>

Indicator status	Lighting red		Blinking red
Status	The filter is clogged. The ambient or internal temperature is abnormally high.		Air filter unit is not attached.
Cause	<ul style="list-style-type: none"> Is the air filter unit dirty? 	<ul style="list-style-type: none"> Is the intake/exhaust vent blocked? 	<ul style="list-style-type: none"> Is the air filter unit attached?
Solution	<ul style="list-style-type: none"> Clean or replace the air filter unit. (➔ page 177) 	<ul style="list-style-type: none"> Remove any objects that are blocking the intake/exhaust vent. 	<ul style="list-style-type: none"> Attach the air filter unit.

Note

- If the filter indicator <FILTER> is still lit or blinking after taking the measures, ask your dealer for repair.
- If the air filter unit is not attached when the projector is turned on, the filter indicator <FILTER> will blink red.

Maintenance/replacement

Before performing maintenance/replacement

- Make sure to turn off the projector and disconnect the power plug from the outlet before maintaining or replacing the unit. (➔ pages 52, 61)
- When switching off the projector, make sure to follow the procedures in “Switching off the projector” (➔ page 61).

Maintenance

Outer case

Wipe off dirt and dust with a soft, dry cloth.

- If the dirt is persistent, soak the cloth with water and wring it thoroughly before wiping. Dry off the projector with a dry cloth.
- Do not use benzene, thinner, or rubbing alcohol, other solvents, or household cleaners. Doing so may deteriorate the outer case.
- When using chemically treated dust cloths, follow the instructions written on its packaging.

Lens front surface

Wipe off dirt and dust from the front surface of the lens with a soft clean cloth.

- Do not use a cloth that is fluffy, dusty, or soaked with oil/water.
- Since the lens is fragile, do not use excessive force when wiping the lens.

Attention

- The lens may be damaged if you hit with a hard object or wipe with excessive force. Handle with care.

Air filter unit

Perform maintenance of the air filter unit in the following case.

- The air filter is clogged with dust, causing the filter replacement message to appear on the screen and the filter indicator <FILTER> to light red.

Attention

- Make sure to secure the stability of the projector, and perform the maintenance in a safe location even if the air filter cover or the air filter unit falls accidentally.
- When the air filter unit is replaced, reset the filter counter.
If the filter counter is not reset after replacing the air filter unit, [FILTER COUNTER has reached the set time.] is displayed.
For details of resetting the filter counter, refer to “Resetting the filter counter” (➔ page 179).

Removing the air filter unit

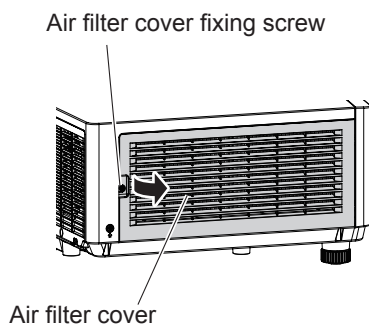

Fig. 1

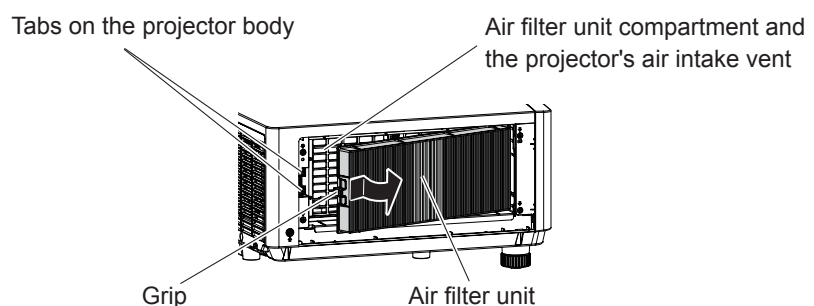

Fig. 2

1) Turn off the power of the projector.

- Always follow the procedure of “Switching off the projector” (➔ page 61) when turning off the power.

2) Remove the air filter cover. (Fig. 1)

- Turn the air filter cover fixing screw (x 1) counterclockwise with a Phillips screwdriver until it turns freely, and remove the air filter cover by placing a finger in the depressed section and pull it out slowly in the direction of the arrow.
- When pulling out the air filter cover, make sure to place a hand on the air filter cover. Pulling it out too rapidly may cause the air filter cover to fall.

3) Pull out the air filter unit. (Fig. 2)

- Slightly push the grip of the air filter unit inward in the direction of the arrow, remove from the tabs on the projector body, and pull out the air filter unit.
- After pulling out the air filter unit, remove any foreign object and dust from the air filter unit compartment and the projector's intake vent.

Performing maintenance of the air filter unit

Remove the air filter unit in advance with the procedure for “Removing the air filter unit” (➡ page 177) described previously.

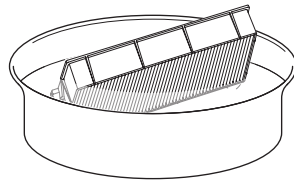

Fig. 1

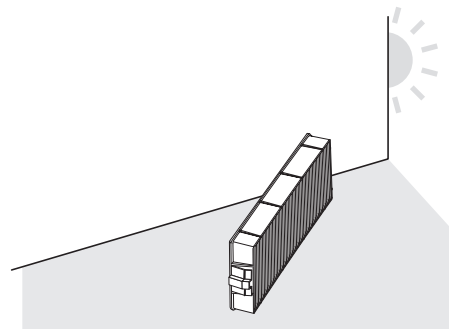

Fig. 2

1) Wash the air filter unit. (Fig. 1)

- i) Soak the air filter unit in cold or warm water and then lightly rinse it.
 - Do not use cleaning tools such as brushes.
 - When rinsing, hold the frame of the air filter unit without putting strong pressure on the filter unit.
- ii) Rinse the air filter unit two to three times using fresh water each time.
 - Insufficient rinsing may result in odors.

2) Dry the air filter unit. (Fig. 2)

- Let the air filter unit naturally dry off in a well-ventilated place where there is little dust and is not exposed to direct sunlight.
- Do not dry using drying devices such as dryers.
- Once the air filter is dried, proceed to “Attaching the air filter unit” (➡ page 178) next.

Attaching the air filter unit

1) Attach the air filter unit to the projector.

- Attach the air filter unit in the reverse procedure of Step 3) in “Removing the air filter unit” (➡ page 177).
- Push in the air filter unit all the way in until it clicks.

2) Attach the air filter cover.

- Close the air filter cover in the reverse procedure of Step 2) in “Removing the air filter unit” (➡ page 177), and press it in all the way until it clicks.
- Securely tighten the air filter cover fixing screw (x 1) using a Phillips screwdriver.

Resetting the filter counter

- 1) Turn on the power of the projector.
- 2) Press the <MENU> button on the remote control or control panel.
 - The [MAIN MENU] screen is displayed.
- 3) Press ▲▼ to select [PROJECTOR SETUP].
- 4) Press the <ENTER> button.
 - The [PROJECTOR SETUP] screen is displayed.
- 5) Press ▲▼ to select [FILTER COUNTER].
- 6) Press the <ENTER> button.
 - The [FILTER COUNTER] screen is displayed.
- 7) Press ▲▼ to select [FILTER COUNTER RESET], and press the <ENTER> button.
- 8) The confirmation screen is displayed, so press ◀▶ to select [OK], and press the <ENTER> button.
 - Display of [FILTER COUNTER] will change to [0 H].

Attention

- After washing the air filter unit, dry it thoroughly before attaching it back to the projector. Attaching a wet unit will cause an electric shock or malfunction.
- Do not disassemble the air filter unit.
- Make sure that the air filter unit is properly attached before using the projector. If it is not attached, the projector will suck in dirt and dust causing a malfunction.
- Do not insert object from the hole of the intake vent. Doing so may cause damage.

Note

- When the projector is used without resetting the filter counter, the actual filter runtime (counter numeric value) will not be able to be confirmed.
- When the projector is used without attaching the air filter unit, the filter indicator <FILTER> will blink red, and a message is displayed on the projected image for approximately 30 seconds.
- When the air filter unit is damaged or dirt does not come off even if it is washed, replace with the new optional Replacement Filter Unit (Model No.: ET-RFM100).
- Replacement to a new air filter unit is recommended after washing it twice.
- The dust-proof properties may be reduced after each cleaning.
- The replacement cycle of the air filter unit varies greatly depending on the usage environment.

Replacing the unit

Air filter unit

Air filter unit should be replaced if the dirt does not come off after cleaning.

The Replacement Filter Unit (Model No.: ET-RFM100) is an optional accessory. To purchase the product, consult your dealer.

Air filter unit replacement procedure

Attention

- Make sure to turn off the projector before replacing the filter.
 - When attaching the air filter unit, make sure to secure the stability of the projector, and execute in a safe location even if the air filter unit falls accidentally.
- 1) Remove the air filter unit.
 - Refer to “Removing the air filter unit” (➡ page 177).
 - 2) Attach the optional Replacement Filter Unit (Model No.: ET-RFM100) to the projector.
 - The air filter unit has no difference between top and bottom, but is two-sided. Match the protrusion position of the air filter unit with the grooves on the projector body.
 - Refer to “Attaching the air filter unit” (➡ page 178).

Attention

- When switching on the projector, make sure that the air filter unit is attached. If it is not attached, the projector will suck in dirt and dust causing a malfunction.
- When the projector is used without attaching the air filter unit, the filter indicator <FILTER> will blink red, and a message is displayed on the projected image for approximately 30 seconds.

Note

- The replacement cycle of the air filter unit varies greatly depending on the usage environment.

Troubleshooting

Review the following points. For details, see the corresponding pages.

Problems	Points to be checked	Page
Power does not turn on.	• Is the power plug firmly inserted into the outlet?	—
	• Is the <MAIN POWER> switch set to <OFF>?	61
	• Is the wall outlet supplying electricity?	—
	• Have the circuit breakers tripped?	—
	• Is the light source indicator <LIGHT> blinking?	175
	• Is the temperature indicator <TEMP> lit or blinking?	176
No image appears.	• Are connections to external devices correctly performed?	46
	• Is the input selection setting correct?	62
	• Is the [BRIGHTNESS] adjustment setting at a minimum?	79
	• Is the external device that is connected to the projector working properly?	—
	• Is the shutter function in use?	66, 107
	• If the power indicator <ON (G)/STANDBY (R)> is blinking red, consult your dealer.	—
Image is fuzzy.	• Is the lens focus set correctly?	63
	• Is the projection distance appropriate?	38
	• Is the lens dirty?	27
	• Is the projector installed perpendicular to the screen?	—
Color is pale or grayish.	• Are [COLOR] and [TINT] adjusted correctly?	80, 80
	• Is the external device connected to the projector adjusted correctly?	46
	• Is the computer cable damaged?	—
Audio is not output.	• Is the external device connected correctly to the audio input terminal?	33
	• Is the volume set to minimum?	67, 121
	• Is the mute function used?	66, 121
	• Is [AUDIO IN SELECT] in [AUDIO SETTING] correctly set?	121
	• Is there a cable connected to the <AUDIO OUT> terminal?	46
Remote control does not respond.	• Are the batteries depleted?	—
	• Is the polarity of the batteries set correctly?	34
	• Are there any obstructions between the remote control and the remote control signal receiver of the projector?	31
	• Is the remote control being used beyond its effective operation range?	31
	• Are other forms of light, such as fluorescent light, affecting the projection?	31
	• Is the [REMOTE CONTROL] setting in [CONTROL DEVICE SETUP] set to [DISABLE]?	135
	• Is the ID number setting operation correct?	72
Menu screen does not appear.	• Is the on-screen display function turned off (hidden)?	67
Buttons on the control panel do not operate.	• Is the [CONTROL PANEL] setting in [CONTROL DEVICE SETUP] set to [DISABLE]?	135
Image does not display correctly.	• Is [SYSTEM SELECTOR] set properly?	83
	• Is there a problem with the video tape or other image sources?	—
	• Is a signal which is not compatible with the projector being input?	205
Image from a computer does not appear.	• Is the cable too long? (For D-Sub cables, the cable length should be 10 m (32'10") or shorter.)	—
	• Is the external video output on the laptop computer set correctly? (Ex.: The external output settings may be switched by pressing the "Fn" + "F3" keys or the "Fn" + "F10" keys simultaneously. This will differ depending on the model of the computer. Refer to the user manual provided with your computer.)	—
Video from HDMI compatible device does not appear or it appears jumbled.	• Is the HDMI cable connected securely?	46
	• Turn the power of the projector and the external device off and on.	—
	• Is a signal which is not compatible with the projector being input?	205
No audio is coming from the HDMI compatible device.	• Set the audio for connected device to linear PCM.	—

Chapter 6 Maintenance — Troubleshooting

Problems	Points to be checked	Page
Cannot control the projector with Art-Net.	• Are the connections between the twisted-pair-cable transmitter and an external device, and between the twisted-pair-cable transmitter and projector correctly done?	—
	• Is [Art-Net SETUP] set to other than [OFF]?	145
	• Are [NET], [SUB NET], [UNIVERSE], and [START ADDRESS] set correctly?	145
The DIGITAL LINK input image is not displayed.	• Is the cable compatible to the condition of the projector used?	48
	• Are the connections between the twisted-pair-cable transmitter and an external device, and between the twisted-pair-cable transmitter and projector correctly done?	—
	• Is [DIGITAL LINK MODE] set to [AUTO] or [DIGITAL LINK]? Is it set to [ETHERNET]?	137
	• Is a signal which is not compatible with a twisted-pair-cable transmitter being input?	—
Operation noise became loud.	If the temperature inside the projector becomes high, the speed of the internal cooling fan increases automatically and the operation noise becomes loud. If the internal temperature reaches the abnormal value, the indicators will light up or blink.	175
	• Is the ambient temperature high?	24
	• Is the air filter unit dirty?	177
	• Is the intake/exhaust vent blocked?	24

Attention

- If problems persist even after checking the preceding points, consult your dealer.

[SELF TEST] display

[SELF TEST] can be checked in the [PROJECTOR SETUP] menu → [STATUS] → [SELF TEST].

The following list shows the alphanumeric symbol that is displayed when an error or a warning has occurred and its details. Confirm “Action number”, and follow the measure in “Measure for error and warning” (➔ page 184).

Error/warning display	Details	Action number
U04	Filter clogging warning	6
U11	Intake temperature warning	1
U13	Exhaust air temperature warning	1
U16	Light source temperature 1 warning	1
U18	Light source temperature 2 warning	1
U21	Intake temperature error	1
U23	Exhaust air temperature error	1
U25	Light source temperature 1 error	1
U27	Light source temperature 2 error	1
U76	Filter not attached warning	6
U78	Filter clogging error	6
U84	<DC OUT> terminal power supply error	4
H01	Battery replacement for the internal clock	3
H11	Intake air temperature sensor error	4
H13	Exhaust air temperature sensor error	4
H14	Light source temperature sensor 1 error	4
H16	Light source temperature sensor 2 error	4
F16	Angle sensor error	4
F18	Air pressure sensor error	4
F50	Power source intake fan warning	4
F51	Power source exhaust fan warning	4
F52	LCD panel red fan warning	4
F53	LCD panel green fan warning	4
F54	LCD panel blue fan warning	4
F55	PBS fan warning	4
F56	Phosphor wheel fan warning	4
F57	Light source fan warning	4
F61	Light source driver communication error	4
F90	FPGA configuration error	4
F96	Lens mounter operation error	4
FE1	Power supply intake fan error	4
FE2	Power supply exhaust fan error	4
FE3	LCD panel red fan error	4
FE4	LCD panel green fan error	4
FE5	LCD panel blue fan error	4
FE6	PBS fan error	4
FE7	Phosphor wheel fan error	4
FE8	Light source fan error	4
FH1	Phosphor wheel error	4
FL1	Light source unit error	5

Note

- The self-diagnosis display and the details of the malfunction may be different.
- For errors and warnings that are not described in the table, consult your dealer.

■ Measure for error and warning

Action number	Measure
1	The operating environment temperature is too high. Use the projector in an appropriate operating environment temperature*1.
2	The operating environment temperature is too low. Use the projector in an appropriate operating environment temperature*1.
3	Battery replacement is required. Consult your dealer.
4	If the display does not clear after switching the main power off and on, consult your dealer.
5	The light source has failed to turn on. If the light source does not light up after turning the power off and on, consult your dealer.
6	Perform maintenance or replacement of the filter. (➡ page 177)

*1 For the operating environment temperature of the projector, refer to "Operating temperature" (➡ page 201).

Chapter 7 Appendix

This chapter describes specifications and after-sales service for the projector.

Technical information

Using the PJLink function

The network function of this projector supports the PJLink class 1 and class 2, and setting of the projector or querying of the projector status can be performed from the computer using the PJLink protocol.

Note

- Setting the password of the administrator account (➔ page 140) is required for using the PJLink function of the projector.

PJLink commands

The following table lists the PJLink commands supported by the projector.

- x characters in tables are non-specific characters.

Class	Command	Control details	Parameter/response string	Remark		
1	POWR	Power supply control	0 1	Standby Power on		
1	POWR?	Power supply status query	0 1 2	Standby Power on Preparing for switching off the projector		
1, 2	INPT	Input selection	11	COMPUTER		
	INPT?	Input selection query	31 32 33 34	HDMI1 HDMI2 HDMI3 DIGITAL LINK		
1	AVMT	Shutter control/audio output control	10 11 20	Shutter function disabled (shutter: open), mute function disabled Shutter function enabled (shutter: closed), mute function disabled Shutter function disabled (shutter: open), mute function disabled		
	AVMT?	Shutter status query/audio output status query	21 30 31	Shutter function disabled (shutter: open), mute function enabled (muted) Shutter function disabled (shutter: open), mute function disabled Shutter function enabled (shutter: closed), mute function enabled (muted)		
1	ERST?	Error status query	xxxxxx	1st byte	Indicates fan errors, and returns 0 or 2.	<ul style="list-style-type: none"> • 0 = No error is detected • 1 = Warning • 2 = Error
				2nd byte	Indicates light source errors, and returns 0 or 2.	
				3rd byte	Indicates temperature errors, and returns 0 - 2.	
				4th byte	Returns 0.	
				5th byte	Returns 0.	
				6th byte	Indicates other errors, and returns 0 - 2.	
1	LAMP?	Light source status query	AAAA X	AAAA: Light source runtime X: 0 = Light source off, 1 = Light source on		
1, 2	INST?	Input selection list query	11 31 32 33 34	—		
1	NAME?	Projector name query	xxxxx	Returns the name set in the [NETWORK] menu → [PROJECTOR NAME].		
1	INF1?	Manufacturer name query	Panasonic	Returns manufacturer name.		
1	INF2?	Model name query	PT-MZ880 PT-MZ780 PT-MZ680	Returns model name.		
1	INF0?	Other information queries	xxxxx	Returns information such as version number.		
1	CLSS?	Class information query	2	Returns class for PJLink.		
2	SNUM ?	Serial number query	xxxxxxxxx	Returns serial number.		

Class	Command	Control details	Parameter/response string	Remark
2	SVER ?	Software version query	xxxxxxxx	Returns version number.
2	INNM ?	Input terminal name query	11 / COMPUTER 31 / HDMI1 32 / HDMI2 33 / HDMI3 34 / DIGITAL LINK	Returns input terminal name.
2	IRES ?	Input signal resolution query	AAAAxBBBB	AAAA: Horizontal resolution BBBB: Vertical resolution
2	RRES ?	Recommended resolution query	1920x1200	—
2	FILT ?	Filter runtime inquiry	xxxxx	Returns the runtime of the filter.
2	RFIL ?	Filter replacement model number inquiry	ET-RFM100	Returns the filter replacement model number.
2	FREZ	Freeze control	0	Freeze function cancel Freeze function (stop)
	FREZ ?	Freeze status query	1	
2	LKUP	Link up notification	xx:xx:xx:xx:xx:xx	Notifies the MAC address when the PJLink communication becomes possible.
2	SRCH	Projector search	ACKN=xx:xx:xx:xx:xx:xx	The projector connected to the same network that can communicate with PJLink will respond with its MAC address.

PJLink security authentication

A PJLink password for security authentication is required for PJLink command communication.

The PJLink password can be set from the [NETWORK] menu → [PJLink] → [PJLink PASSWORD] (➡ page 143) or from the [Set up password] page (➡ page 162) of the web control screen.

When using the PJLink commands without security authentication, set the PJLink password to blank. The factory default setting of PJLink password is blank.

- For specifications related to PJLink, visit the website of Japan Business Machine and Information System Industries Association.

URL <http://pjlink.jbmia.or.jp/english/>

Using Art-Net function

Since the network function of the projector supports the Art-Net function, you can control the projector settings with the DMX controller and application software using the Art-Net protocol.

Note

- Setting the password of the administrator account (➡ page 140) is required for using the Art-Net function of the projector.

Channel definition

The following table lists the channel definitions used for controlling the projector with the Art-Net function.

Channel settings can be switched using the [NETWORK] menu → [Art-Net] → [Art-Net CHANNEL SETTING] (➡ page 145).

The control details assigned to each channel are listed in the following table.

- Channel assignment for [USER] is in factory default setting. Assignment can be changed.

Channel	Control details		
	[2]	[USER]	[1]
CHANNEL1	LIGHT OUTPUT	LIGHT OUTPUT	SHUTTER
CHANNEL2	INPUT SELECT	INPUT SELECT	INPUT SELECT
CHANNEL3	LENS POSITION	LENS POSITION	LENS FUNCTION SELECT
CHANNEL4	LENS H SHIFT	LENS H SHIFT	LENS CONTROL
CHANNEL5	LENS V SHIFT	LENS V SHIFT	POWER
CHANNEL6	LENS FOCUS	LENS FOCUS	LIGHT OUTPUT
CHANNEL7	LENS ZOOM	LENS ZOOM	ENABLE / DISABLE
CHANNEL8	POWER	POWER	FADE-IN
CHANNEL9	SCREEN ADJUSTMENT	SCREEN ADJUSTMENT	FADE-OUT

Channel	Control details		
	[2]	[USER]	[1]
CHANNEL10	NONE	NONE	NONE
CHANNEL11	ENABLE / DISABLE	ENABLE / DISABLE	SCREEN ADJUSTMENT
CHANNEL12	NONE	NONE	NONE

Control details

■ **LIGHT OUTPUT**

This can be set in 256 steps between 100 % and 0 %.

Performance	Parameter	Default value
100 %	0	0
...	...	
0 %	255	

■ **INPUT SELECT (when [Art-Net CHANNEL SETTING] is set to [1])**

Performance	Parameter	Default value
No operation	0-7	0
COMPUTER	8-15	
No operation	16-39	
HDMI	40-47	
DIGITAL LINK	48-55	
No operation	56-255	

■ **INPUT SELECT (when [Art-Net CHANNEL SETTING] is set to [2] or [USER])**

Performance	Parameter	Default value
No operation	0-7	0
COMPUTER	8-15	
No operation	16-31	
HDMI1	32-39	
DIGITAL LINK	40-47	
No operation	48-71	
HDMI2	72-79	
HDMI3	80-87	
No operation	88-255	

■ **LENS POSITION**

Performance	Parameter	Default value
No operation	0-31	0
Move to the home position	32-63	
No operation	64-255	

■ **LENS H SHIFT, LENS V SHIFT, LENS FOCUS, LENS ZOOM**

Performance	Parameter	Default value		
Lens adjustment	(-) High speed	0-31	128	
	(-) Low speed	32-63		
	(-) Fine adjustment	64-95		
Operation stop	96-159	128		
Lens adjustment	(+) Fine adjustment			160-191
	(+) Low speed			192-223
	(+) High speed	224-255		

■ **LENS FUNCTION SELECT (when [Art-Net CHANNEL SETTING] is set to [1])**

Operate together with LENS CONTROL.

Performance	Parameter	Default value
No operation	0-15	0
LENS H SHIFT	16-31	
LENS V SHIFT	32-47	
LENS FOCUS	48-63	
LENS ZOOM	64-79	
Move to the home position	80-95	
No operation	96-255	

■ **LENS CONTROL (when [Art-Net CHANNEL SETTING] is set to [1])**

Operate together with LENS FUNCTION SELECT.

Performance	Parameter	Default value	
Lens adjustment	(-) High speed	0-31	100
	(-) Low speed	32-63	
	(-) Fine adjustment	64-95	
Operation stop	96-127		
Lens adjustment	(+) Fine adjustment	128-159	
	(+) Low speed	160-191	
	(+) High speed	192-223	
Execute command action	224-255		

■ **POWER**

Performance	Parameter	Default value
Standby	0-63	128
No operation	64-191	
Power on	192-255	

■ **SHUTTER**

Performance	Parameter	Default value
SHUTTER: Open, mute clear	0-63	128
No operation	64-191	
SHUTTER: Closed, mute	192-255	

■ **FADE-IN, FADE-OUT (when [Art-Net CHANNEL SETTING] is set to [1] or [USER])**

Operate together with SHUTTER.

Performance	Parameter	Default value
OFF	0-15	255
0.5s	16-31	
1.0s	32-47	
1.5s	48-63	
2.0s	64-79	
2.5s	80-95	
3.0s	96-111	
3.5s	112-127	
4.0s	128-143	
5.0s	144-159	
7.0s	160-175	
10.0s	176-191	
No operation	192-255	

■ SCREEN ADJUSTMENT

Performance	Parameter	Default value
OFF	0-15	255
KEystone	16-31	
CURVED CORRECTION	32-47	
PC-1	48-63	
PC-2	64-79	
PC-3	80-95	
CORNER CORRECTION	96-111	
No operation	112-255	

■ FREEZE

Performance	Parameter	Default value
No operation	0-31	128
OFF	32-95	
No operation	96-159	
ON	160-223	
No operation	224-255	

■ COLOR, TINT

Performance	Parameter	Default value
No operation	0-31	0
Factory default setting	32-63	
-31	64	
...	...	
0	128-129	
...	...	
+31	191	
No operation	192-255	

■ RASTER PATTERN

Performance	Parameter	Default value
No operation	0-15	0
OFF	16-31	
WHITE	32-47	
YELLOW	48-63	
CYAN	64-79	
GREEN	80-95	
MAGENTA	96-111	
RED	112-127	
BLUE	128-143	
BLACK	144-159	
USER LOGO	160-175	
No operation	176-255	

■ [AUDIO VOLUME]

Performance	Parameter	Default value
No operation	0-31	0
Factory default setting	32-63	
0	64-65	
...	...	
63	190-191	
No operation	192-255	

■ ENABLE / DISABLE

Operation for all channels is not accepted when set to “Disable”.

Performance	Parameter	Default value
Disable	0-127	0
Enable	128-255	

Note

- If the projector is operated using the remote control or the control panel, or by the control command while controlling the projector using the Art-Net function, the setting of the DMX controller or computer application may be different from the projector status. To reflect the controls of all channels to the projector, set “ENABLE / DISABLE” of channel 11 to “Disable” and then back to “Enable”.
- To create and register the USER LOGO image, use “Logo Transfer Software”. The software can be downloaded from the website (<https://panasonic.net/cns/projector/>).

Control commands via LAN

The projector can be controlled via the <DIGITAL LINK/LAN> terminal or the <LAN> terminal by using the control command format via the <SERIAL/MULTI SYNC IN> terminal.

For examples of the available commands, refer to “Control command” (➡ page 197).

Note

- Setting the password of the administrator account is required (➡ page 140) for sending and receiving the commands via LAN.

When connecting in protected mode

Connecting

This is the connection method when [NETWORK] menu → [NETWORK SECURITY] → [COMMAND PROTECT] is set to [ENABLE].

- 1) Obtain the IP address and port number (Initial set value = 1024) of the projector and request a connection to the projector.

- You can obtain both the IP address and the port number from the menu screen of the projector.

IP address	Obtain from the [NETWORK] menu → [NETWORK STATUS].
Port number	Obtain from the [NETWORK] menu → [NETWORK CONTROL] → [COMMAND PORT].

- 2) Check the response from the projector.

	Data section	Blank	Mode	Blank	Random number section	Termination symbol
Command example	“NTCONTROL” (ASCII string)	‘ ’ 0x20	‘1’ 0x31	‘ ’ 0x20	“zzzzzzzz” (ASCII code hex number)	(CR) 0x0d
Data length	9 bytes	1 byte	1 byte	1 byte	8 bytes	1 byte

- Mode: 1 = Protect mode
- Example: Response during protect mode (random number section is undefined value)
“NTCONTROL 1 23181e1e” (CR)

- 3) Generate a 32-byte hash value from the following data using MD5 algorithm.

- “xxxxxx:yyyy:zzzzzzzz”

xxxxxx	User name of the administrator account
yyyyy	Password of the administrator account
zzzzzzz	8-byte random number obtained in Step 2)

Command transmission method

Transmit using the following command formats.

■ Transmitted data

	Header		Data section	Termination symbol
Command example	Hash value "Connecting" (➔ page 191)	'0' 0x30	'0' 0x30	Control command (ASCII string) (CR) 0x0d
Data length	32 bytes	1 byte	1 byte	Undefined length 1 byte

- Example: Transmission of power supply status acquisition command (hash value is calculated from the user name and password of the administrator account, and acquired random number)
"dbdd2dabd3d4d68c5dd970ec0c29fa6400QPW" (CR)

■ Received data

	Header		Data section	Termination symbol
Command example	'0' 0x30	'0' 0x30	Control command (ASCII string)	(CR) 0x0d
Data length	1 byte	1 byte	Undefined length	1 byte

- Example: The projector is powered on
"00001" (CR)

■ Error response

	String	Details	Termination symbol
Message	"ERR1"	Undefined control command	(CR) 0x0d
	"ERR2"	Out of parameter range	
	"ERR3"	Busy state or no-acceptable period	
	"ERR4"	Timeout or no-acceptable period	
	"ERR5"	Wrong data length	
	"ERRA"	Password mismatch	
Data length	4 bytes	—	1 byte

Note

- The projector will automatically disconnect the connection with the network right after sending the command. This is the specification based on the security view point to prevent unauthorized operation of this product by a malicious third party. To send commands continuously, execute the network connection request every time the command is to be sent. For details, refer to "Communication flow between server and client" (➔ page 193).

When connecting in non-protected mode

Connecting

This is the connection method when [NETWORK] menu → [NETWORK SECURITY] → [COMMAND PROTECT] is set to [DISABLE].

1) Obtain the IP address and port number (Initial set value = 1024) of the projector and request a connection to the projector.

- You can obtain both the IP address and the port number from the menu screen of the projector.

IP address	Obtain from the [NETWORK] menu → [NETWORK STATUS].
Port number	Obtain from the [NETWORK] menu → [NETWORK CONTROL] → [COMMAND PORT].

2) Check the response from the projector.

	Data section	Blank	Mode	Termination symbol
Command example	"NTCONTROL" (ASCII string)	' ' 0x20	'0' 0x30	(CR) 0x0d
Data length	9 bytes	1 byte	1 byte	1 byte

- Mode: 0 = Non-protect mode
- Example: Response during non-protect mode
"NTCONTROL 0" (CR)

Command transmission method

Transmit using the following command formats.

■ Transmitted data

	Header		Data section	Termination symbol
Command example	'0' 0x30	'0' 0x30	Control command (ASCII string)	(CR) 0x0d
Data length	1 byte	1 byte	Undefined length	1 byte

- Example: Transmission of power supply status acquisition command
"00QPW" (CR)

■ Received data

	Header		Data section	Termination symbol
Command example	'0' 0x30	'0' 0x30	Control command (ASCII string)	(CR) 0x0d
Data length	1 byte	1 byte	Undefined length	1 byte

- Example: The power of the projector is in standby status
"00000" (CR)

■ Error response

	String	Details	Termination symbol
Message	"ERR1"	Undefined control command	(CR) 0x0d
	"ERR2"	Out of parameter range	
	"ERR3"	Busy state or no-acceptable period	
	"ERR4"	Timeout or no-acceptable period	
	"ERR5"	Wrong data length	
Data length	4 bytes	—	1 byte

Note

- The projector will automatically disconnect the connection with the network right after sending the command. This is the specification based on the security view point to prevent unauthorized operation of this product by a malicious third party. To send commands continuously, execute the network connection request every time the command is to be sent. For details, refer to "Communication flow between server and client" (➔ page 193).

Communication flow between the server and the client

When sending / receiving commands via LAN, refer to the communication flow shown below.

Server: the projector

Client: the control device such as a computer

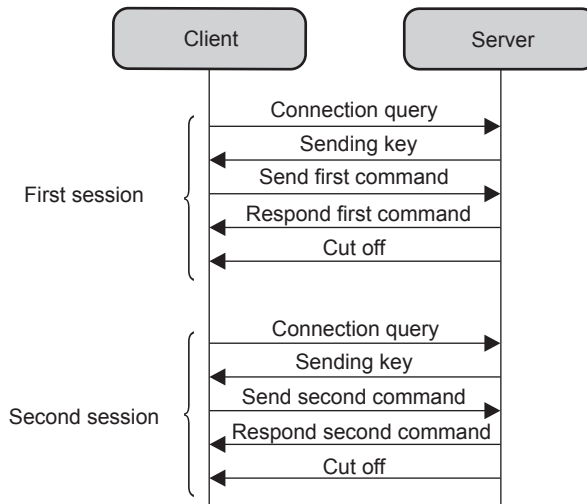

<SERIAL/MULTI SYNC IN> / <MULTI SYNC OUT> terminals

The <SERIAL/MULTI SYNC IN> terminal of the projector conforms with RS-232C so that the projector can be connected to and controlled from a computer.

A combined screen with a balanced contrast can be displayed by linking multiple projectors using the <SERIAL/MULTI SYNC IN> terminal and the <MULTI SYNC OUT> terminal, and sharing the brightness level of the video signal input to each projector when structuring a multi-display screen by combining the projected images from multiple projectors. It is also possible to synchronize the shutter operation of the specified projector to other projectors.

For the connection method of the projectors when using the contrast synchronization function or the shutter synchronization function, refer to “Connecting example when using the contrast synchronization function/shutter synchronization function” (➡ page 49).

Connection for RS-232C communication

When connecting directly

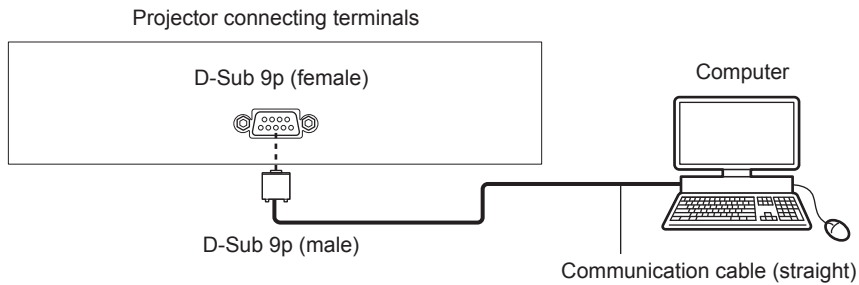

When connecting using DIGITAL LINK compatible device

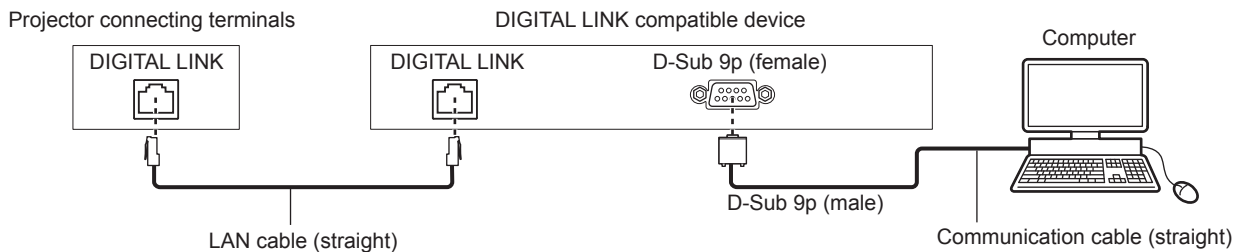

Note

- The destination of [RS-232C] (➔ page 118) must be set according to the connection method.
- When connecting using a DIGITAL LINK compatible device, set the [PROJECTOR SETUP] menu → [ECO MANAGEMENT] → [STANDBY MODE] to [NORMAL] to control the projector in the standby mode.
When [STANDBY MODE] is set to [ECO], the projector cannot be control during standby.

Pin assignments and signal names

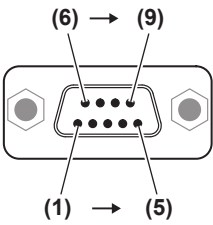
D-Sub 9-pin (female) Outside view	Pin No.	Signal name	Details
	(1)	—	NC
	(2)	TXD	Transmitted data
	(3)	RXD	Received data
	(4)	MULTI PROJECTOR SYNC	For contrast synchronization function/for shutter synchronization function
	(5)	GND	Earth
	(6)	—	NC
	(7)	CTS	Connected internally
	(8)	RTS	
	(9)	—	NC

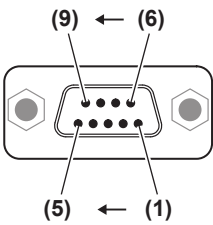
D-Sub 9-pin (male) Outside view	Pin No.	Signal name	Details
	(1)	—	NC
	(2)	—	NC
	(3)	—	NC
	(4)	MULTI PROJECTOR SYNC	For contrast synchronization function/for shutter synchronization function
	(5)	GND	Earth
	(6)	—	NC
	(7)	RTS	Connected internally
	(8)	CTS	
	(9)	—	NC

RS-232C communication conditions (factory default)

Signal level	RS-232C-compliant
Sync. method	Asynchronous
Baud rate	9 600 bps
Parity	None
Character length	8 bits
Stop bit	1 bit
X parameter	None
S parameter	None

Basic format

Transmission from the computer starts with STX, then the ID, command, parameter, and ETX are sent in this order. Add parameters according to the details of control.

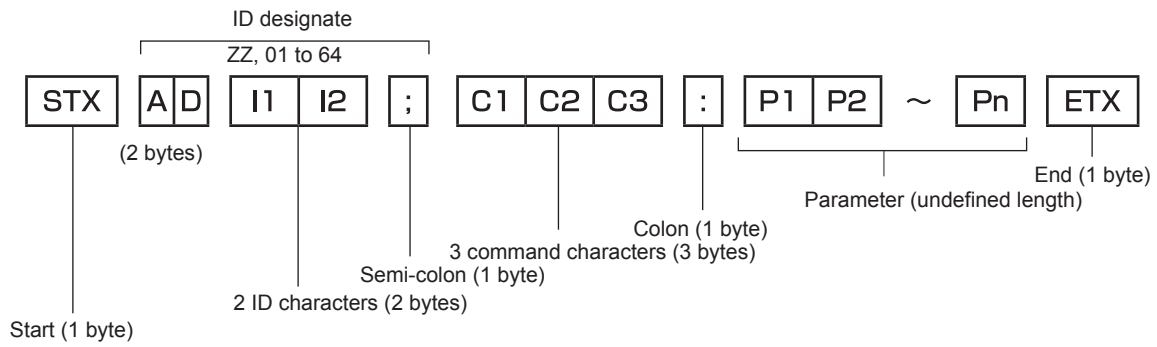

Basic format (has subcommands)

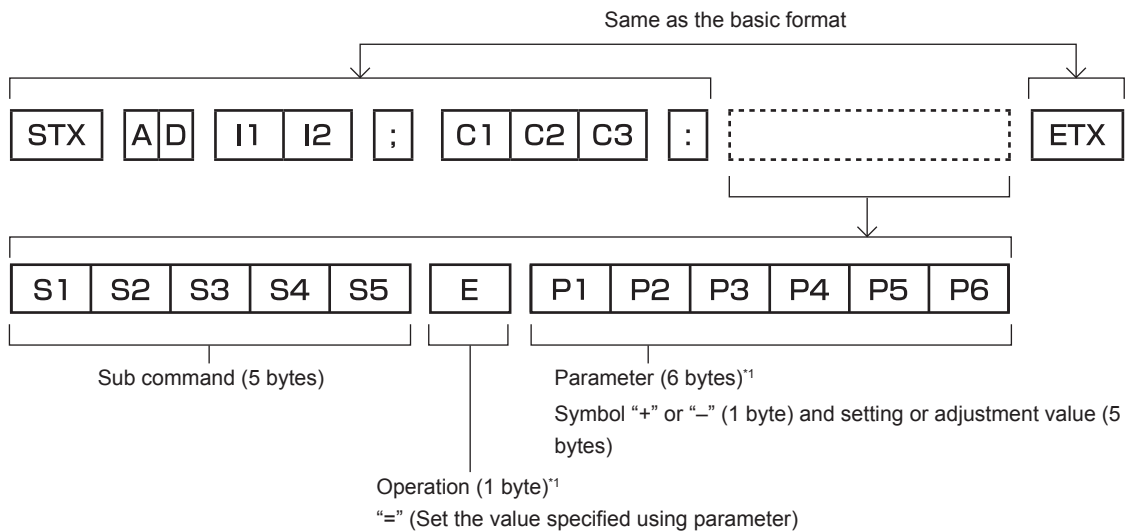

*1 When transmitting a command which does not need a parameter, an operation (E) and parameter are not necessary.

Attention

- If a command is sent after the light source starts lighting, there may be a delay in response or the command may not be executed. Try sending or receiving any command after 60 seconds.
- When transmitting multiple commands, be sure to wait until 0.5 seconds has elapsed after receiving the response from the projector before sending the next command. When transmitting a command which does not need a parameter, a colon (:) is not necessary.

Note

- If a command cannot be executed, the "ER401" response is sent from the projector to the computer.
- If an invalid parameter is sent, the "ER402" response is sent from the projector to the computer.
- ID transmission in RS-232C supports ZZ (ALL) and 01 to 64.
- If a command is sent with an ID designated, a response will be sent to the computer only in the following cases.
 - It matches the projector ID
 - When the [PROJECTOR SETUP] menu → [PROJECTOR ID] is set to [ALL] on the projector
- STX and ETX are character codes. STX shown in hexadecimal is 02, and ETX shown in hexadecimal is 03.

Cable specification

When connected to a computer

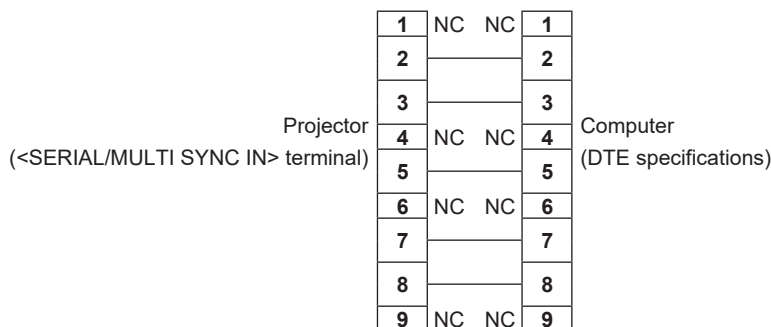

Control command

The following table lists the commands that can be used to control the projector using a computer.

■ Projector control command

Command	Details	Parameter/response string	Remark (parameter)
PON	Power on	—	To check if the power is on, use the "Power query" command.
POF	Power standby		
QPW	Power query	000 001	STANDBY Power on
IIS	Switching the input signal	RG1 HD1 HD2 HD3 DL1	COMPUTER HDMI1 HDMI2 HDMI3 DIGITAL LINK
OSH	Shutter control	0	OPEN
QSH	Shutter status query	1	CLOSE
VSE	Aspect ratio switch	0 1 2 5	NORMAL 4:3 WIDE NATIVE
QSE	Aspect ratio settings query	6 9 10	FULL H FIT V FIT
OCS	Sub memory switch	01 - 96	Sub memory number
QSB	Sub memory status query		

■ Lens control command

Command	Sub command	Details	Remark
VXX	LNSI2	Lens H shift	+00000 = Fine adjustment 1+, +00001 = Fine adjustment 1-, +00100 = Fine adjustment 2+, +00101 = Fine adjustment 2-, +00200 = Coarse adjustment+, +00201 = Coarse adjustment-
VXX	LNSI3	Lens V shift	
VXX	LNSI4	Lens focus	
VXX	LNSI5	Lens zoom	

<REMOTE 2 IN> terminal

The projector can be remotely controlled (contact control) by the control board that is located far away from the projector where the signal from the remote control does not reach.

Use the <REMOTE 2 IN> terminal on the connecting terminals of the projector to connect to the control board.

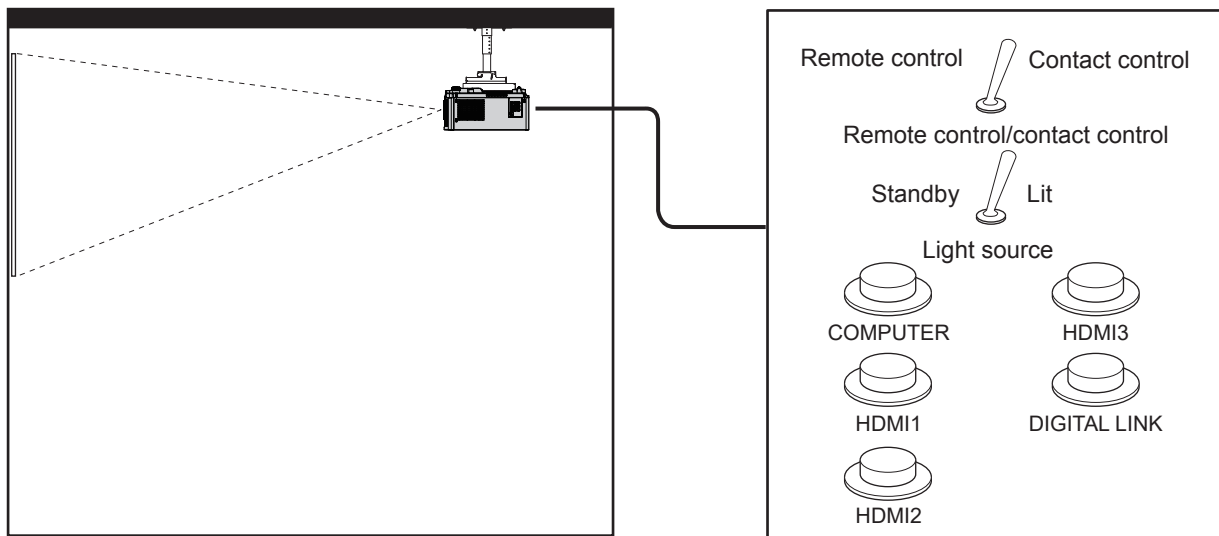

Installation locations in meeting rooms, etc.

Remote control board in another location

Pin assignments and signal names

D-Sub 9-pin Outside view	Pin No.	Signal name	Open (H)	Short (L)
	(1)	GND	—	GND
	(2)	POWER	OFF	ON
	(3)	COMPUTER	Other	COMPUTER
	(4)	HDMI1	Other	HDMI1
	(5)	HDMI2	Other	HDMI2
	(6)	HDMI3	Other	HDMI3
	(7)	DLINK	Other	DLINK
	(8)	SHUTTER	OFF	ON
	(9)	RST/SET	Controlled by remote control	Controlled by external contact

Attention

- When controlling, make sure to short-circuit pins (1) and (9).
- When pins (1) and (9) are short-circuited, the following buttons on the control panel and the remote control are disabled. Commands for RS-232C and network functions corresponding to these functions are also disabled.
 - Power <⏻/⏻> button, <SHUTTER> button
- When pins (1) and (9) are short-circuited, and then any pins from (3) to (7) and the pin (1) are short-circuited, the following buttons on the control panel and the remote control are disabled. Commands for RS-232C and network functions corresponding to these functions are also disabled.
 - Power <⏻/⏻> button, <INPUT SELECT> button, <COMPUTER> button, <HDMI 1> button, <HDMI 2> button, <HDMI 3> button, <DIGITAL LINK> button, <SHUTTER> button

Note

- Setting of the pin (2) to pin (8) can be changed when the [PROJECTOR SETUP] menu → [REMOTE2 MODE] is set to [USER]. (➡ page 120)

<COMPUTER IN> terminal pin assignment and signal name

Outside view	Pin No.	Signal name	Pin No.	Signal name
	(1)	R/P _R	(9)	+5 V
	(2)	G/Y	(10)	GND
	(3)	B/P _B	(11)	GND
	(4)	—	(12)	DDC data
	(5)	GND	(13)	SYNC/HD
	(6)	GND	(14)	VD
	(7)	GND	(15)	DDC clock
	(8)	GND		

<MONITOR OUT> terminal pin assignment and signal name

Outside view	Pin No.	Signal name	Pin No.	Signal name
	(1)	R/P _R	(9)	—
	(2)	G/Y	(10)	GND
	(3)	B/P _B	(11)	GND
	(4)	—	(12)	—
	(5)	GND	(13)	SYNC/HD
	(6)	GND	(14)	VD
	(7)	GND	(15)	—
	(8)	GND		

Specifications

The specifications of the projector are as follows.

Display system		Translucent screen LCD panel x 3, 3 primary colors system	
Display device	Size of effective display area	19.3 mm (0.76") (aspect ratio 16:10)	
	Number of pixels	2 304 000 pixels (1 920 x 1 200 dots)	
Projection lens	Supplied projection lens	Throw ratio: 1.6 to 2.8:1 F = 1.7 to 2.3 f = 26.8 mm to 45.5 mm	
	Zoom	Powered	
	Focus	Powered	
	Lens shift	Powered (Horizontal/Vertical)	
	Changeable lens	Yes	
Light source		Laser diode	
Screen size		1.02 m (40") to 10.16 m (400")	
		1.52 m (60") to 10.16 m (400")	with ET-ELW22
Light output^{*1 *2}	PT-MZ880	8 000 lm	When [PICTURE MODE] is set to [DYNAMIC] and [LIGHT POWER] in [ECO MANAGEMENT] is set to [NORMAL]
	PT-MZ780	7 000 lm	
	PT-MZ680	6 000 lm	
	PT-MZ880	5 600 lm	When [PICTURE MODE] is set to [DYNAMIC] and [LIGHT POWER] in [ECO MANAGEMENT] is set to [ECO] or [QUIET]
	PT-MZ780	4 900 lm	
	PT-MZ680	4 200 lm	
Contrast ratio^{*1}		3 000 000:1	When [PICTURE MODE] is set to [DYNAMIC], [DYNAMIC CONTRAST] is set to [1] or [2], and HDMI signal is input
Center to corner zone ratio^{*1}		85%	
Displayable scanning frequency	Horizontal	27 kHz to 135 kHz	
	Vertical	24 Hz to 60 Hz	
Input compatibility	HDMI signal input	Moving image signal resolution: 480/60p, 576/50p to 4 096 x 2 160/60p Still image signal resolution: 640 x 480 to 1 920 x 1 200 (non-interlace) Dot clock frequency: 25 MHz to 594 MHz	
	DIGITAL LINK signal input	Moving image signal resolution: 480/60p, 576/50p to 4 096 x 2 160/60p Still image signal resolution: 640 x 480 to 1 920 x 1 200 (non-interlace) Dot clock frequency: 25 MHz to 297 MHz	
	RGB signal input	Resolution: 640 x 480 to 1 920 x 1 200 Dot clock frequency: 162 MHz or less PIAS (Panasonic Intelligent Auto Scanning) system	
	Y_CB_CR/YP_BP_R signal input	Resolution: 480/60p, 576/50p to 1 920 x 1 080 Dot clock frequency: 148.5 MHz or less The HD/SYNC and VD terminals do not support 3 value SYNC.	

*1 Measurement, measuring conditions, and method of notation all comply with ISO/IEC 21118:2020 international standards.

*2 Value is for the supplied standard zoom lens. The value varies depending on the lens.

Chapter 7 Appendix — Specifications

Connecting terminals	<HDMI IN 1> terminal <HDMI IN 2> terminal <HDMI IN 3> terminal	HDMI x 3, HDCP 2.3 compatible, Deep Color compatible	
		Audio signal Linear PCM (sampling frequency: 48 kHz/44.1 kHz/32 kHz)	
	<DIGITAL LINK/LAN> terminal	RJ-45 x 1, for network and DIGITAL LINK connections (HDBaseT™ compliant), PLink (class 2) compatible, 100Base-TX, Art-Net compatible, HDCP 2.3 compatible, Deep Color compatible	
	<LAN> terminal	RJ-45 x 1, for network connection, PLink (class 2) compatible, 10Base-T/100Base-TX, Art-Net compatible	
	<COMPUTER IN> terminal	High-density D-Sub 15 p (female) x 1 RGB signal 0.7 V [p-p] 75 Ω (SYNC ON GREEN: 1.0 V [p-p] 75 Ω) SYNC/HD TTL high impedance, automatic positive/negative polarity compatible VD TTL high impedance, automatic positive/negative polarity compatible YPbPr signal Y: 1.0 V [p-p] including synchronization signal, PbPr: 0.7 V [p-p] 75 Ω	
	<MONITOR OUT> terminal	High-density D-Sub 15 p (female) x 1 RGB signal 0.7 V [p-p] 75 Ω (SYNC ON GREEN: 1.0 V [p-p] 75 Ω) SYNC/HD TTL high impedance, positive/negative polarity VD TTL high impedance, positive/negative polarity YPbPr signal Y: 1.0 V [p-p] including synchronization signal, PbPr: 0.7 V [p-p] 75 Ω	
	<AUDIO IN> terminal	M3 stereo mini jack x 1, 0.5 V [rms], input impedance 22 kΩ or more	
	<AUDIO OUT> terminal	M3 stereo mini jack x 1, 0 V [rms] to 2.0 V [rms] (variable), output impedance 2.2 kΩ or lower	
	<SERIAL/MULTI SYNC IN> terminal	D-Sub 9 p x 1, RS-232C compliant, for computer control	
	<MULTI SYNC OUT> terminal	D-Sub 9 p x 1	
	<REMOTE 1 IN> terminal	M3 stereo mini jack x 1, for remote control (wired)	
	<REMOTE 2 IN> terminal	D-Sub 9 p x 1, for contact control	
	<DC OUT> terminal	USB connector (type A) x 1, for power supply only (DC 5 V, maximum 2 A)	
Acoustic noise*1	PT-MZ880	34 dB	When [LIGHT POWER] in [ECO MANAGEMENT] is set to [NORMAL] or [ECO].
	PT-MZ780, PT-MZ680	32 dB	
	PT-MZ880	27 dB	When [LIGHT POWER] in [ECO MANAGEMENT] is set to [QUIET]
	PT-MZ780, PT-MZ680	26 dB	
Operating environment	Operating temperature	0 °C (32 °F) to 45 °C (113 °F)*2	
	Operating humidity	20 % to 80 % (no condensation)	
Operation position		[FLOOR/CEILING], [FRONT/REAR]	

*1 Measurement, measuring conditions, and method of notation all comply with ISO/IEC 21118:2020 international standards.

*2 The projector cannot be used at an altitude of 2 700 m (8 858') or higher above sea level.

If the operating environment temperature exceeds the following value, the light output may be reduced to protect the projector.

- When using the projector at an altitude lower than 700 m (2 297') above sea level: 36 °C (97 °F)
- When using the projector at an altitude between 700 m (2 297') and 1 400 m (4 593') above sea level: 34 °C (93 °F)
- When using the projector at an altitude between 1 400 m (4 593') and 2 100 m (6 890') above sea level: 32 °C (90 °F)
- When using the projector at an altitude between 2 100 m (6 890') and 2 700 m (8 858') above sea level: 30 °C (86 °F)

Chapter 7 Appendix — Specifications

Power requirements		110 V ~ (110 V alternating current), 60 Hz (for Taiwan)		
		100 V - 240 V ~ (100 V - 240 V alternating current), 50 Hz/60 Hz (for other countries and regions)		
Maximum power consumption		PT-MZ880	490 W (5.0 A) (for Taiwan)	
			490 W (5.4 A - 2.6 A) (The power consumption is 465 W at 200 V - 240 V.) (for other countries and regions)	
		PT-MZ780	435 W (4.5 A) (for Taiwan)	
			435 W (4.8 A - 2.3 A) (The power consumption is 415 W at 200 V - 240 V.) (for other countries and regions)	
		PT-MZ680	360 W (4.0 A) (for Taiwan)	
			360 W (4.2 A - 2.0 A) (The power consumption is 345 W at 200 V - 240 V.) (for other countries and regions)	
Standby mode power consumption		Approx. 0.5 W		
		When [STANDBY MODE] is set to [ECO]		
		Approx. 15 W		
		When [STANDBY MODE] is set to [NORMAL], [IN STANDBY MODE] in [AUDIO SETTING] is set to [OFF], [QUICK STARTUP] is set to [OFF], and <DC OUT> terminal is not in use		
		Approx. 35 W		
		When [STANDBY MODE] is set to [NORMAL], [IN STANDBY MODE] in [AUDIO SETTING] is set to [ON], [QUICK STARTUP] is set to [OFF], and <DC OUT> terminal supplies power (2 A)		
		PT-MZ880, PT-MZ780	Approx. 115 W	
		PT-MZ680	Approx. 100 W	
		When [STANDBY MODE] is set to [NORMAL], [IN STANDBY MODE] in [AUDIO SETTING] is set to [ON], [QUICK STARTUP] is set to [ON], and <DC OUT> terminal supplies power (2 A)		
Standard outside dimensions	Width	561 mm (22-3/32")		
	Height	224 mm (8-13/16") (with the feet at shortest position)		
	Depth	439 mm (17-9/32") (including standard zoom lens)		
Weight*1		PT-MZ880, PT-MZ780	Approx. 18.6 kg (41 lbs.) (including standard zoom lens)	
		PT-MZ680	Approx. 17.6 kg (39 lbs.) (including standard zoom lens)	
Outer case	Materials	Molded plastic		
	Color	White / Black		
Power cord length		For Taiwan: 2.0 m (78-3/4") For other countries and regions: 3.0 m (118-1/8")		
Laser Classification	Laser Class	USA and Canada: Class 3R (IEC 60825-1:2007)		
		Other countries or regions: Class 1 (IEC/EN 60825-1:2014)		
	Risk Group	Standard zoom lens / ET-ELS20, ET-ELW20, ET-ELT22, ET-ELW22, ET-ELW21	Risk group 2 (IEC 62471-5:2015)	
		ET-ELT23	Risk group 3 (IEC 62471-5:2015)	
Remote control	Power requirements	DC 3 V (AAA/R03/LR03 battery x 2)		
	Operating range	Within approx. 30 m (98'5") (when operated directly in front of signal receiver)		
	Weight	102 g (3.6 ozs.) (including batteries)		
	Outside dimensions	Width: 48 mm (1-7/8"), Height: 145 mm (5-23/32"), Depth: 27 mm (1-1/16")		

*1 Average value. Weight varies for each product.

Note

- The model numbers of accessories and optional accessories are subject to change without prior notice.

Dimensions

Unit: mm (inch)

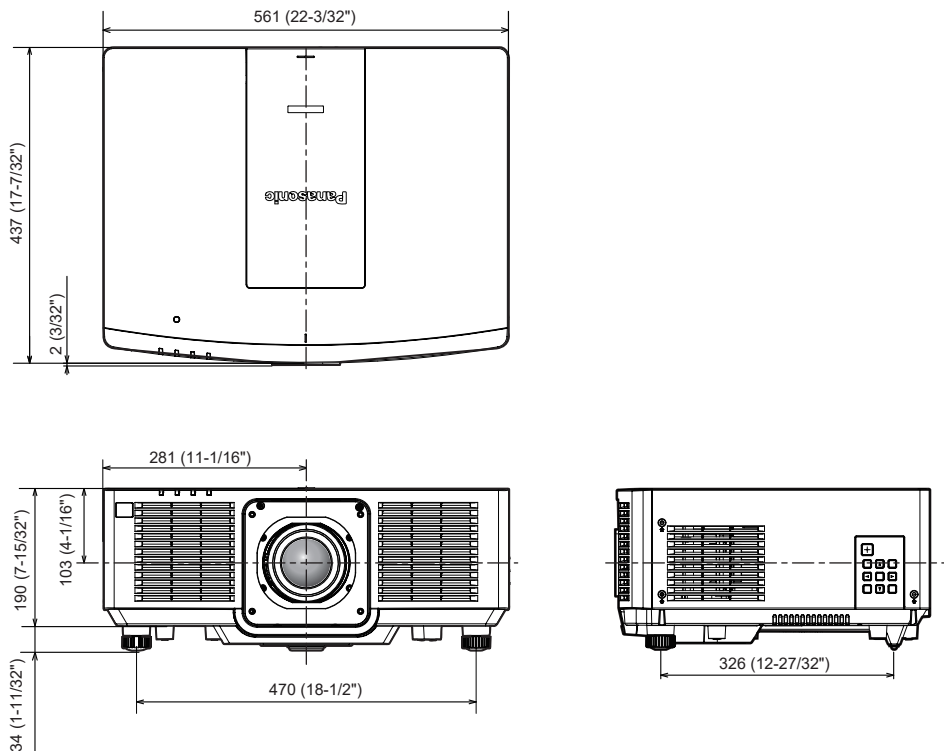

* The above dimensions are obtained when the standard zoom lens is attached.

* Actual dimensions may differ depending on the product.

Precautions for attaching the Ceiling Mount Bracket

- When installing the projector to a ceiling, use the Ceiling Mount Bracket (Model No.: ET-PKD120H (for High Ceilings), ET-PKD120S (for Low Ceilings)) together with Ceiling Mount Bracket (Model No.: ET-PKE301B (Projector Mount Bracket)).

Model No.: ET-PKD120H (for High Ceilings), ET-PKD120S (for Low Ceilings), ET-PKE301B (Projector Mount Bracket)

- Attach the drop-prevention set that comes with the Ceiling Mount Bracket to the projector. If you need the drop-prevention set (Service Model No.: DPPW1004ZA/X1) is necessary, consult your dealer.
- When the projector is mounted to the existing Ceiling Mount Bracket (in combination with the Model No.: ET-PKD120H (for High Ceilings) or ET-PKD120S (for Low Ceilings), and the Model No.: ET-PKE300B (Projector Mount Bracket)), it is necessary to replace the drop-prevention wire rope with the one corresponding to this projector. Consult your dealer.

Drop-prevention set (service model no.: DPPW1004ZA/X1)

- Ask a qualified technician to do the installation work such as mounting the projector on the ceiling.
- Panasonic Connect Co., Ltd. takes no responsibility for any damage to the projector resulting from use of the Ceiling Mount Bracket not manufactured by Panasonic Connect Co., Ltd. or the inappropriate choice of location for installing the Ceiling Mount Bracket, even if the warranty period of the projector has not expired.
- Unused products must be removed promptly by a qualified technician.
- Use a torque screwdriver or Allen torque wrench to tighten bolts to their specified tightening torques. Do not use electric screwdrivers or impact screwdrivers.
- Read the Installation Instructions of the Ceiling Mount Bracket for details.
- The model numbers of accessories and optional accessories are subject to change without prior notice.

■ Specification for the screw holes to fix the projector (projector bottom view)

Unit: mm (inch)

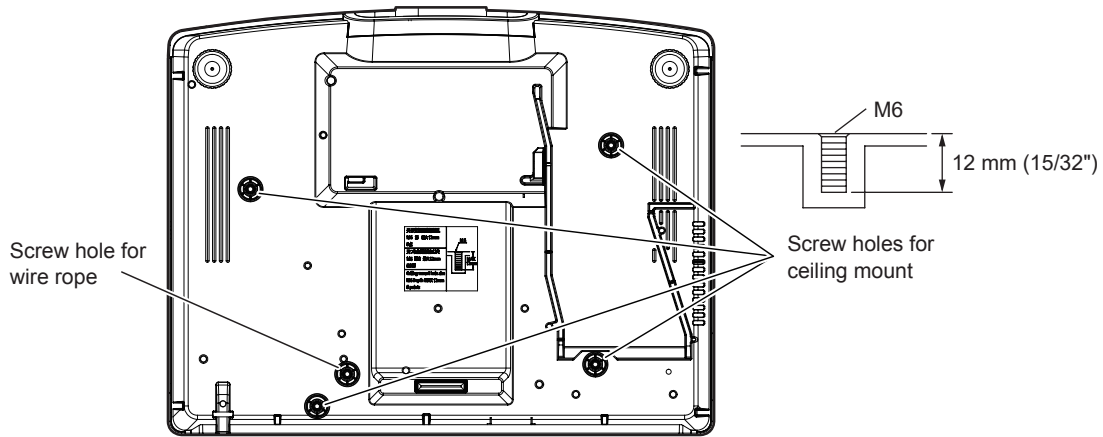

■ Dimensions for the screw holes to fix the projector (projector bottom view)

Unit: mm (inch)

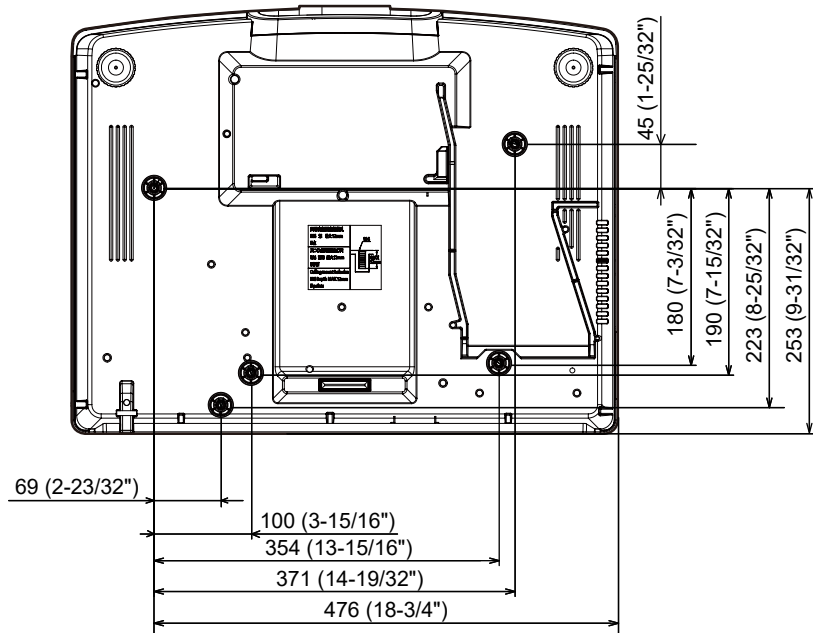

List of compatible signals

The following table specifies the video signals compatible with the projector.

This signal with ✓ in the supported signal column is supported.

• The content of the compatible signal column is as follows.

- COMPUTER: COMPUTER input
- HDMI: HDMI1/HDMI2/HDMI3 input
- DIGITAL LINK: DIGITAL LINK input

Signal name (SIGNAL FORMAT)	Resolution (Dots)	Scanning freq.		Dot clock freq. (MHz)	Compatible signal		
		Horizontal (kHz)	Vertical (Hz)		COMPUTER	HDMI	DIGITAL LINK
480/60p	720 x 480	31.5	59.9	27.0	✓	✓	✓
576/50p	720 x 576	31.3	50.0	27.0	✓	✓	✓
720/60p	1 280 x 720	45.0	60.0 ²	74.3	✓	✓	✓
720/50p	1 280 x 720	37.5	50.0	74.3	✓	✓	✓
1080/60i	1 920 x 1 080i	33.8	60.0 ²	74.3	✓	✓	✓
1080/50i	1 920 x 1 080i	28.1	50.0	74.3	✓	✓	✓
1080/24p	1 920 x 1 080	27.0	24.0 ²	74.3	✓	✓	✓
1080/24sF	1 920 x 1 080i	27.0	48.0 ²	74.3	✓	✓	✓
1080/25p	1 920 x 1 080	28.1	25.0	74.3	✓	✓	✓
1080/30p	1 920 x 1 080	33.8	30.0 ²	74.3	✓	✓	✓
1080/60p	1 920 x 1 080	67.5	60.0 ²	148.5	✓	✓	✓
1080/50p	1 920 x 1 080	56.3	50.0	148.5	✓	✓	✓
3840 x 2160/24p	3 840 x 2 160	54.0	24.0 ²	297.0	—	✓	✓
3840 x 2160/25p	3 840 x 2 160	56.3	25.0	297.0	—	✓	✓
3840 x 2160/30p	3 840 x 2 160	67.5	30.0 ²	297.0	—	✓	✓
3840 x 2160/60p	3 840 x 2 160	135.0	60.0 ²	297.0	—	✓ ³	✓ ³
	3 840 x 2 160	135.0	60.0 ²	594.0	—	✓	—
3840 x 2160/50p	3 840 x 2 160	112.5	50.0	297.0	—	✓ ³	✓ ³
	3 840 x 2 160	112.5	50.0	594.0	—	✓	—
4096 x 2160/24p	4 096 x 2 160	54.0	24.0 ²	297.0	—	✓	✓
4096 x 2160/25p	4 096 x 2 160	56.3	25.0	297.0	—	✓	✓
4096 x 2160/30p	4 096 x 2 160	67.5	30.0 ²	297.0	—	✓	✓
4096 x 2160/60p	4 096 x 2 160	135.0	60.0 ²	297.0	—	✓ ³	✓ ³
	4 096 x 2 160	135.0	60.0 ²	594.0	—	✓	—
4096 x 2160/50p	4 096 x 2 160	112.5	50.0	297.0	—	✓ ³	✓ ³
	4 096 x 2 160	112.5	50.0	594.0	—	✓	—
640 x 480/60	640 x 480	31.5	59.9	25.2	✓	✓	✓
1024 x 768/50	1 024 x 768	39.6	50.0	51.9	✓	✓	✓
1024 x 768/60	1 024 x 768	48.4	60.0	65.0	✓	✓	✓
1280 x 800/50	1 280 x 800	41.3	50.0	68.0	✓	✓	✓
1280 x 800/60	1 280 x 800	49.7	59.8	83.5	✓	✓	✓
1280 x 1024/50	1 280 x 1 024	52.4	50.0	88.0	✓	✓	✓
1280 x 1024/60	1 280 x 1 024	64.0	60.0	108.0	✓	✓	✓
1366 x 768/50	1 366 x 768	39.6	49.9	69.0	✓	✓	✓
1366 x 768/60	1 366 x 768	47.7	59.8	85.5	✓	✓	✓
1400 x 1050/50	1 400 x 1 050	54.1	50.0	99.9	✓	✓	✓
1400 x 1050/60	1 400 x 1 050	65.2	60.0	122.6	✓	✓	✓
1440 x 900/50	1 440 x 900	46.3	49.9	86.8	✓	✓	✓
1440 x 900/60	1 440 x 900	55.9	59.9	106.5	✓	✓	✓
1600 x 900/50	1 600 x 900	46.4	49.9	96.5	✓	✓	✓
1600 x 900/60	1 600 x 900	55.9	60.0	119.0	✓	✓	✓
1600 x 1200/50	1 600 x 1 200	61.8	49.9	131.5	✓	✓	✓
1600 x 1200/60	1 600 x 1 200	75.0	60.0	162.0	✓	✓	✓

Chapter 7 Appendix — Specifications

Signal name (SIGNAL FORMAT)	Resolution (Dots)	Scanning freq.		Dot clock freq. (MHz)	Compatible signal		
		Horizontal (kHz)	Vertical (Hz)		COMPUTER	HDMI	DIGITAL LINK
1680 x 1050/50	1 680 x 1 050	54.1	50.0	119.5	✓	✓	✓
1680 x 1050/60	1 680 x 1 050	65.3	60.0	146.3	✓	✓	✓
1920 x 1200/50	1 920 x 1 200	61.8	49.9	158.3	✓	✓	✓
1920 x 1200/60RB	1 920 x 1 200 ^{*1}	74.0	60.0	154.0	✓	✓	✓

*1 VESA CVT-RB (Reduced Blanking)-compliant

*2 The signal with 1/1.001x vertical scanning frequency is also supported.

*3 YPbPr 4:2:0 format only

Note

- A signal with a different resolution is converted to the number of display dots. The number of display dots is as follows.
 - 1 920 x 1 200
- The “i” at the end of the resolution indicates an interlaced signal.
- When interlaced signals are connected, flickering may occur on the projected image.
- When the DIGITAL LINK connection is made with the long-reach communication method, the signal that the projector can receive is up to 1080/60p (1 920 x 1 080 dots, dot clock frequency 148.5 MHz).
- Even if it is the signal listed in the list of compatible signals, it may not be displayed by the projector if the video signal is recorded in a special format.

List of plug and play compatible signals

The following table specifies the video signals compatible with plug and play.

Signal with ✓ in the plug and play compatible signal column is the signal described in the EDID (extended display identification data) of the projector. For the signal without ✓ in the plug and play compatible signal column, the resolution may not be selected on the computer even if the projector is supporting it.

- Input corresponding to each item in the plug and play compatible signal column is as follows.
 - COMPUTER: COMPUTER input
 - HDMI: HDMI1/HDMI2/HDMI3 input
 - DIGITAL LINK: DIGITAL LINK input

Signal name (SIGNAL FORMAT)	Resolution (Dots)	Scanning freq.		Dot clock freq. (MHz)	Plug and play compatible signal						
		Horizontal (kHz)	Vertical (Hz)		COMPUTER	HDMI			DIGITAL LINK		
						4K/60P	4K/30P	2K	4K/60P	4K/30P	2K
480/60p	720 x 480	31.5	59.9	27.0	—	✓	✓	✓	✓	✓	✓
576/50p	720 x 576	31.3	50.0	27.0	—	✓	✓	✓	✓	✓	✓
720/60p	1 280 x 720	45.0	60.0 ^{*2}	74.3	—	✓	✓	✓	✓	✓	✓
720/50p	1 280 x 720	37.5	50.0	74.3	—	✓	✓	✓	✓	✓	✓
1080/60i	1 920 x 1 080i	33.8	60.0 ^{*2}	74.3	—	✓	✓	✓	✓	✓	✓
1080/50i	1 920 x 1 080i	28.1	50.0	74.3	—	✓	✓	✓	✓	✓	✓
1080/24p	1 920 x 1 080	27.0	24.0 ^{*2}	74.3	—	✓	✓	✓	✓	✓	✓
1080/24sF	1 920 x 1 080i	27.0	48.0 ^{*2}	74.3	—	—	—	—	—	—	—
1080/25p	1 920 x 1 080	28.1	25.0	74.3	—	✓	✓	✓	✓	✓	✓
1080/30p	1 920 x 1 080	33.8	30.0 ^{*2}	74.3	—	✓	✓	✓	✓	✓	✓
1080/60p	1 920 x 1 080	67.5	60.0 ^{*2}	148.5	—	✓	✓	✓	✓	✓	✓
1080/50p	1 920 x 1 080	56.3	50.0	148.5	—	✓	✓	✓	✓	✓	✓
3840 x 2160/24p	3 840 x 2 160	54.0	24.0 ^{*2}	297.0	—	✓	✓	—	✓	✓	—
3840 x 2160/25p	3 840 x 2 160	56.3	25.0	297.0	—	✓	✓	—	✓	✓	—
3840 x 2160/30p	3 840 x 2 160	67.5	30.0 ^{*2}	297.0	—	✓	✓	—	✓	✓	—
3840 x 2160/60p	3 840 x 2 160	135.0	60.0 ^{*2}	297.0	—	✓ ^{*3}	—	—	✓ ^{*3}	—	—
	3 840 x 2 160	135.0	60.0 ^{*2}	594.0	—	✓	—	—	—	—	—
3840 x 2160/50p	3 840 x 2 160	112.5	50.0	297.0	—	✓ ^{*3}	—	—	✓ ^{*3}	—	—
	3 840 x 2 160	112.5	50.0	594.0	—	✓	—	—	—	—	—
4096 x 2160/24p	4 096 x 2 160	54.0	24.0 ^{*2}	297.0	—	✓	✓	—	✓	✓	—
4096 x 2160/25p	4 096 x 2 160	56.3	25.0	297.0	—	✓	✓	—	✓	✓	—
4096 x 2160/30p	4 096 x 2 160	67.5	30.0 ^{*2}	297.0	—	✓	✓	—	✓	✓	—

Chapter 7 Appendix — Specifications

Signal name (SIGNAL FORMAT)	Resolution (Dots)	Scanning freq.		Dot clock freq. (MHz)	Plug and play compatible signal						
		Horizontal (kHz)	Vertical (Hz)		COMPUTER	HDMI			DIGITAL LINK		
						4K/60P	4K/30P	2K	4K/60P	4K/30P	2K
4096 x 2160/60p	4 096 x 2 160	135.0	60.0 ^{*2}	297.0	—	✓ ^{*3}	—	—	✓ ^{*3}	—	—
	4 096 x 2 160	135.0	60.0 ^{*2}	594.0	—	✓	—	—	—	—	—
4096 x 2160/50p	4 096 x 2 160	112.5	50.0	297.0	—	✓ ^{*3}	—	—	✓ ^{*3}	—	—
	4 096 x 2 160	112.5	50.0	594.0	—	✓	—	—	—	—	—
640 x 480/60	640 x 480	31.5	59.9	25.2	✓	✓	✓	✓	✓	✓	✓
1024 x 768/50	1 024 x 768	39.6	50.0	51.9	—	—	—	—	—	—	—
1024 x 768/60	1 024 x 768	48.4	60.0	65.0	✓	✓	✓	✓	✓	✓	✓
1280 x 800/50	1 280 x 800	41.3	50.0	68.0	—	—	—	—	—	—	—
1280 x 800/60	1 280 x 800	49.7	59.8	83.5	—	—	—	—	—	—	—
1280 x 1024/50	1 280 x 1 024	52.4	50.0	88.0	—	—	—	—	—	—	—
1280 x 1024/60	1 280 x 1 024	64.0	60.0	108.0	—	—	—	—	—	—	—
1366 x 768/50	1 366 x 768	39.6	49.9	69.0	—	—	—	—	—	—	—
1366 x 768/60	1 366 x 768	47.7	59.8	85.5	—	—	—	—	—	—	—
1400 x 1050/50	1 400 x 1 050	54.1	50.0	99.9	—	—	—	—	—	—	—
1400 x 1050/60	1 400 x 1 050	65.2	60.0	122.6	✓	✓	✓	✓	✓	✓	✓
1440 x 900/50	1 440 x 900	46.3	49.9	86.8	—	—	—	—	—	—	—
1440 x 900/60	1 440 x 900	55.9	59.9	106.5	—	—	—	—	—	—	—
1600 x 900/50	1 600 x 900	46.4	49.9	96.5	—	—	—	—	—	—	—
1600 x 900/60	1 600 x 900	55.9	60.0	119.0	✓	✓	✓	✓	✓	✓	✓
1600 x 1200/50	1 600 x 1 200	61.8	49.9	131.5	—	—	—	—	—	—	—
1600 x 1200/60	1 600 x 1 200	75.0	60.0	162.0	✓	✓	✓	✓	✓	✓	✓
1680 x 1050/50	1 680 x 1 050	54.1	50.0	119.5	—	—	—	—	—	—	—
1680 x 1050/60	1 680 x 1 050	65.3	60.0	146.3	—	—	—	—	—	—	—
1920 x 1200/50	1 920 x 1 200	61.8	49.9	158.3	—	—	—	—	—	—	—
1920 x 1200/60RB	1 920 x 1 200 ^{*1}	74.0	60.0	154.0	✓	✓	✓	✓	✓	✓	✓

*1 VESA CVT-RB (Reduced Blanking)-compliant

*2 The signal with 1/1.001x vertical scanning frequency is also supported.

*3 YPbPr 4:2:0 format only

Note

- A signal with a different resolution is converted to the number of display dots. The number of display dots is as follows.
 - 1 920 x 1 200
- The “i” at the end of the resolution indicates an interlaced signal.
- When interlaced signals are connected, flickering may occur on the projected image.
- When the DIGITAL LINK connection is made with the long-reach communication method, the signal that the projector can receive is up to 1080/60p (1 920 x 1 080 dots, dot clock frequency 148.5 MHz).
- Even if it is the signal listed in the list of compatible signals, it may not be displayed by the projector if the video signal is recorded in a special format.

Index

- A**
- Accessories28
 - <AC IN> terminal.....32
 - [ADMINISTRATOR ACCOUNT]140
 - [ADVANCED MENU]77, 91
 - Air filter unit.....177
 - Application software26
 - [Art-Net]145
 - Art-Net26, 187
 - [ASPECT]85
 - <ASPECT> button
 - Remote control.....30, 70
 - Aspect function70
 - [AUDIO SETTING].....121
 - Automatic setup function68
 - [AUTO SETUP].....97
 - <AUTO SETUP/CANCEL> button
 - Remote control.....30, 68
 - [AUTO SIGNAL]97
- B**
- [BACK COLOR]105
 - [BLANKING]91
 - [BRIGHTNESS]79
- C**
- Cautions on use27
 - Cautions when installing.....23
 - Cautions when transporting.....23
 - <CEC> button.....30
 - [CLAMP POSITION]94
 - [CLOCK PHASE].....87
 - [COLOR].....80
 - [COLOR ADJUSTMENT].....96
 - [COLOR CORRECTION].....96
 - [COLOR TEMPERATURE].....80
 - <COMPUTER> button
 - Remote control.....30, 62
 - [COMPUTER IN]98
 - Connecting the power cord.....52
 - Connecting the remote control to the projector with a cable.....34
 - Connection46
 - [CONTRAST].....79
 - [CONTROL DEVICE PASSWORD CHANGE]..136
 - [CONTROL DEVICE SETUP].....135
- D**
- [DATA CLONING]125
 - [DATE AND TIME]114
 - [DAYLIGHT VIEW].....82
 - [DC OUT].....124
 - <DEFAULT> button
 - Remote control.....30, 75
 - Deleting the registered signal.....130
 - [DIGITAL CINEMA REALITY]91
 - [DIGITAL LINK].....137
 - DIGITAL LINK26
 - <DIGITAL LINK> button
 - Remote control.....30, 62
 - [DIGITAL LINK IN]101
 - [DIGITAL LINK MENU]138
 - [DIGITAL LINK MODE]137
 - [DIGITAL LINK STATUS]138
 - [DIGITAL ZOOM]109
 - Dimensions203
 - Display language77, 95
 - [DISPLAY OPTION].....77, 96
 - [DISPLAY SETTING].....133
 - Disposal27
 - [DYNAMIC CONTRAST]83
 - <D.ZOOM-> button
 - Remote control.....30, 69
 - <D.ZOOM+> button
 - Remote control.....30, 69
- E**
- <ECO> button
 - Remote control.....30, 71
 - [ECO MANAGEMENT]111
 - [EDGE BLENDING]92
 - <ENTER> button
 - Projector body33
 - Remote control.....30, 74
 - [ETHERNET TYPE].....137
 - Expanding signal lock-in range.....131
- F**
- [FILTER COUNTER].....123
 - Filter indicator175
 - <FOCUS> button
 - Remote control.....30, 63
 - [FREEZE]109
 - <FREEZE> button
 - Remote control.....30, 67
 - Freeze function.....67
 - Function button70
 - <FUNCTION> button
 - Remote control.....30, 70
 - [FUNCTION BUTTON]120
- G**
- [GAMMA]81
- H**
- <HDMI 1> button
 - Remote control.....30, 62
 - <HDMI 2> button
 - Remote control.....30, 62
 - <HDMI 3> button
 - Remote control.....30, 62
 - [HDMI CEC].....126
 - [HDMI IN].....99
- I**
- <ID ALL> button
 - Remote control.....30, 72
 - <ID SET> button
 - Remote control.....30, 72
 - [INITIALIZE]128
 - Initial setting.....55
 - [INITIAL STARTUP]113
 - [INPUT RESOLUTION]92
 - <INPUT SELECT> button
 - Projector body33, 62
 - Installation mode36
- L**
- [LENS]120
 - <LENS/CANCEL> button
 - Projector body33, 63
 - Light source indicator175
 - List of compatible signals205
 - [LOAD ALL USER DATA].....125
- M**
- Main menu76
 - Main power switch32, 54
 - Maintenance177
 - <MENU> button
 - Projector body32, 33, 74
 - Remote control.....30, 74
 - Menu item76
 - [MENU LOCK]134
 - [MENU LOCK PASSWORD]134
 - [MULTI PROJECTOR SYNC].....116
 - <MULTI SYNC OUT> terminal33, 194
 - <MUTE> button
 - Remote control.....30, 66
- N**
- Navigating through the menu74
 - [NETWORK]78, 137
 - Network connection148
 - [NETWORK CONTROL]143
 - [NETWORK SECURITY].....142
 - [NETWORK STATUS]140
 - [NOISE REDUCTION].....82
- O**
- <ON SCREEN> button
 - Remote control.....30, 67
 - [ON-SCREEN DISPLAY]102
 - On-screen menu74
 - Optional accessories29
- P**
- [PICTURE]76, 79
 - [PICTURE MODE]79
 - [PJLink].....143
 - [POSITION]76, 85
 - Power button
 - Projector body32
 - Remote control.....30
 - Precautions for attaching the Ceiling Mount Bracket203
 - Precautions for use.....23
 - Projecting.....62
 - [PROJECTION METHOD].....110
 - Projector body31
 - [PROJECTOR ID].....110
 - [PROJECTOR NAME]139
 - [PROJECTOR SETUP]77, 110
 - Protecting the registered signal131
 - [P-TIMER].....108
 - <P-TIMER> button
 - Remote control.....30, 70
- R**
- [RASTER POSITION].....94
 - Read this first!.....5
 - [REALTIME KEYSTONE]87
 - Registering new signals.....130
 - <REMOTE 1 IN> terminal.....34
 - <REMOTE 2 IN> terminal.....198
 - [REMOTE2 MODE]120
 - Remote control30
 - Remote control operations66
 - Removing/attaching the projection lens.....44
 - Renaming the registered signal130
 - Replacing the air filter unit179
 - Replacing the unit179
 - Resetting to the factory default.....75
 - <RETURN> button
 - Remote control.....30
 - [RS-232C].....117, 118
- S**
- [SAVE ALL USER DATA]125
 - [SCHEDULE]115
 - <SCREEN ADJ> button
 - Remote control.....30, 68
 - [SCREEN ADJUSTMENT].....88
 - [SCREEN SETTING]97
 - Security.....25
 - [SECURITY]78, 133
 - [SECURITY PASSWORD].....133
 - [SECURITY PASSWORD CHANGE]133
 - Selecting the input signal.....62
 - [SELF TEST] display183
 - <SERIAL/MULTI SYNC IN> terminal.....33, 194
 - [SERVICE PASSWORD]128
 - Setting ID number of the remote control.....72
 - Setting up36
 - [SHARPNESS]82
 - [SHIFT]85
 - <SHIFT> button
 - Remote control.....30, 63
 - <SHUTTER> button
 - Projector body32
 - Remote control.....30, 66
 - [SHUTTER SETTING].....107
 - [SIGNAL LIST].....78, 130
 - [SIGNAL SEARCH]104
 - Specifications200
 - [STARTUP INPUT SELECT]113
 - [STARTUP LOGO].....105
 - [STATUS].....124

<STATUS> button	
Remote control.....	30, 71
Sub memory	132
Switching off the projector	61
Switching on the projector	54
[SYSTEM SELECTOR]	83
T	
Temperature indicator.....	175
[TEST PATTERN]	78, 129
<TEST PATTERN> button	
Remote control.....	30, 70
[TEXT CHANGE].....	134
[TINT].....	80
Troubleshooting.....	181
U	
[UNIFORMITY]	105
Updating the firmware	169
V	
Volume adjustment.....	67
<VOL->/<VOL+> button	
Projector body	32
Remote control.....	30, 67
W	
Web control	151
[WIRED LAN].....	139
Z	
[ZOOM].....	86
<ZOOM> button	
Remote control.....	30, 63

Disposal of Old Equipment and Batteries Only for European Union and countries with recycling systems



These symbols on the products, packaging, and/or accompanying documents mean that used electrical and electronic products and batteries must not be mixed with general household waste. For proper treatment, recovery and recycling of old products and used batteries, please take them to applicable collection points in accordance with your national legislation.



By disposing of them correctly, you will help to save valuable resources and prevent any potential negative effects on human health and the environment.

For more information about collection and recycling, please contact your local authority. Penalties may be applicable for incorrect disposal of this waste, in accordance with national legislation.



Note for the battery symbol (bottom symbol)

This symbol might be used in combination with a chemical symbol. In this case it complies with the requirement set by the Directive for the chemical involved.

Product Information (for Turkey only)

AEEE Yönetmeliğine Uygundur

Panasonic Connect Co., Ltd.

Web Site : <https://panasonic.net/cns/projector/>

© Panasonic Connect Co., Ltd. 2022

Panasonic Connect North America

Two Riverfront Plaza, Newark, NJ 07102

TEL: (877) 803 - 8492

Panasonic Canada Inc.

5770 Ambler Drive, Mississauga, Ontario L4W 2T3

TEL: (905) 624 - 5010

W0521NL2103 -PT