

Panasonic
CONNECT

KAIROS

Incredible **P**roductivity

KAIROS
VERSION
1.3
FIRMWARE

IT/IP Live Video Processing Platform

Worldwide
Olympic Partner



Worldwide
Paralympic Partner





The live video production platform allows flexible system configuration and operation, delivering improved video quality and productivity.

The IT/IP platform "KAIROS" is a live video production platform developed based on a new concept and innovative architecture. It incorporates proprietary, ground-breaking software to maximize the CPU and GPU capacities for video processing. Therefore, KAIROS will be the solution to meet today's requirements of live video production needs to adapt new technologies and create a better sense of reality and new technologies for improving productivity of video production. General-purpose IT equipment is deployed to run on CPU and GPU to take advantage of the most advanced IT technology. And the proprietary, and innovative software technology has enabled unprecedented flexible live video processing with low latency executed on a GPU, while the open software architecture ensures excellent system flexibility and scalability. A variety of video inputs and outputs are available with KAIROS to support not only baseband signals such as SDI but also new IP signals including SMPTE ST2110, NDI[®]* and SRT** to realize remote live video production and streaming.

KAIROS uses the GPU for the video processing, thus allowing flexible video production using multiple layers with unrestricted number of MEs or keys and the "CANVAS" screen unhampered by resolution or format.

Because KAIROS is an IT-based open architecture platform, it enables functional enhancements and control linkage with external devices by adding software. With the system integration capability, KAIROS improves work efficiency and ensures future expandability.

With the new mainframe Kairos Core 1000, these features have been further enhanced, increasing video processing and production composition performance as well as streaming capability.

Achieving flexibility in all levels of production unlike any existing hardware-based systems, KAIROS breaks new ground for live video production.

* NDI[®] is a new protocol developed by NewTek, Inc. that supports IP video production workflow. NDI[®] is a registered trademark of NewTek, Inc. in the United States. In this instance, NDI[®] is used to indicate low latency with high bandwidth NDI[®].

** SRT stands for Secure Reliable Transport.



AT-SFC10 Kairos Creator (GUI Software/Software Key)



AT-KC1000 Kairos Core 1000 (Main Frame)



AT-KC100 Kairos Core 100 (Main Frame)

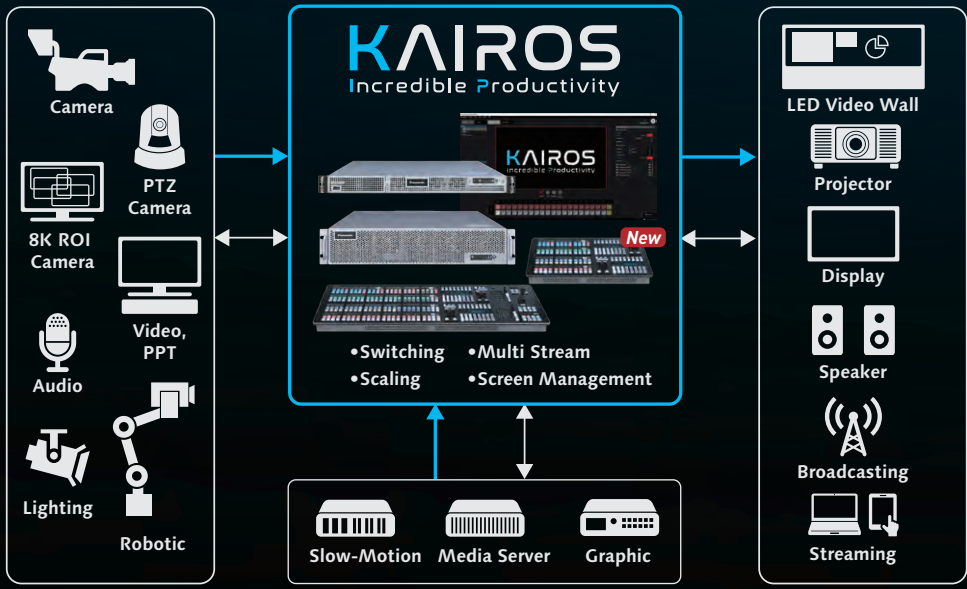
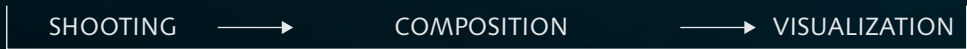

AT-KC10C1 Kairos Control (Control Panel)



AT-KC10C2 Kairos Control (Control Panel) **NEW**

Inputs/outputs

– Variety of video inputs and outputs available for use –

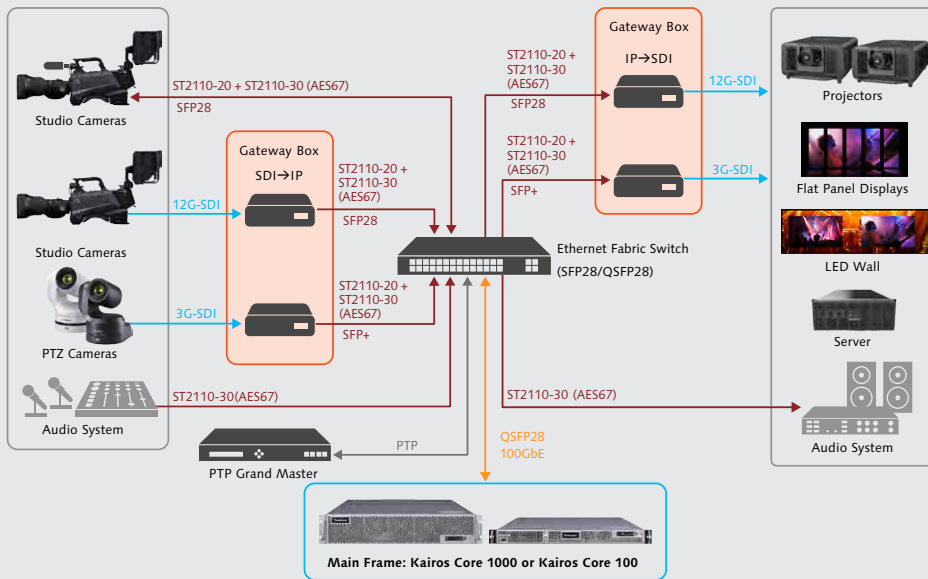

System Integration Example (IP-based)

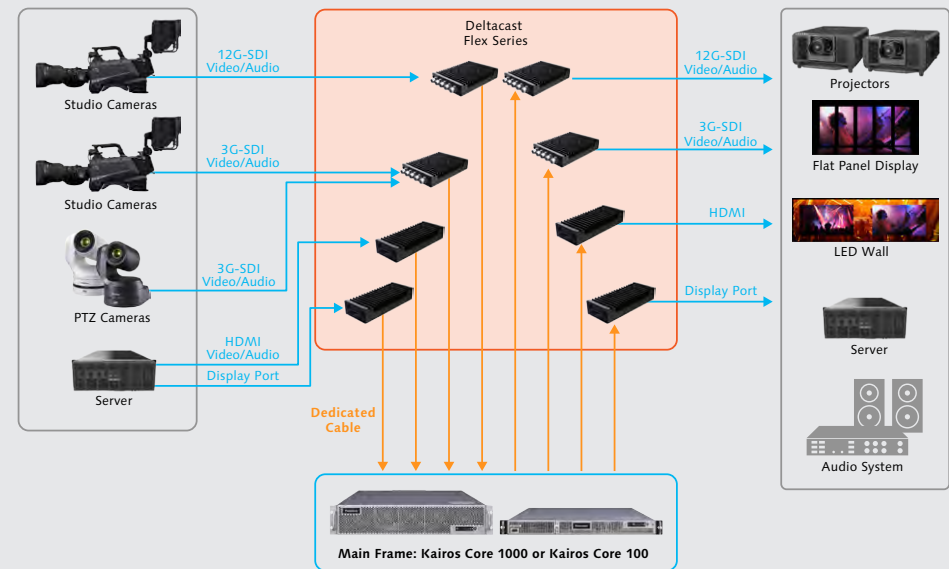

*Deltacast FLEX modules are required for baseband input/output.

System Integration Example (SDI-based)

Compatible with various input and output signals



KAIROS fully supports baseband signal (12G/3G/HD-SDI, HDMI, Display Port) and IP packet (ST 2110, NDI[®], RTP) input and output.

In addition to RTP, RTMP, and RTSP, the SRT^{**} streaming protocol is supported for superior stability and security. And it is equipped with 8 input channels of Kairos Core 1000 or 6 input channels of Kairos Core 100 and 2 output channels, and each channel can be set to selected protocol.^{***}

Audio input/output is supported: 16 channels each for NDI[®] and SRT, and 8 channels each for RTMP and RTSP.

* NDI[®] is a new protocol developed by NewTek, Inc. that supports IP video production workflow. NDI[®] is a registered trademark of NewTek, Inc. in the United States. In this instance, NDI[®] is used to indicate low latency with high bandwidth NDI[®].

** SRT stands for Secure Reliable Transport.

*** For RTSP, only input is supported. Note that RTSP input does not work with the AW-HE130W/K (Discontinued) and AW-HR140 PTZ cameras.

Resolution independent, interlaced video support

Standard video formats with different resolutions such as 4K/HD can be mixed and used. I/P conversion enables the use of 1080/59.94i and 1080/50i interlaced video inputs/outputs.

Supported Video Formats

In / Out	Resolution	Frame Rate
Input	4K (3840 x 2160)*	60p, 59.94p, 50p, 30p, 29.97p, 25p, 24p, 23.98p
	FHD (1920 x 1080)	60p, 59.94p, 50p, 30p, 29.97p, 25p, 24p, 23.98p, 59.94i, 50i
	HD (1280 x 720)	60p, 59.94p, 50p
Output	4K (3840 x 2160)*	60p, 59.94p, 50p, 30p, 29.97p, 25p, 24p, 23.98p
	FHD (1920 x 1080)	60p, 59.94p, 50p, 30p, 29.97p, 25p, 24p, 23.98p, 59.94i, 50i
	HD (1280 x 720)	60p, 59.94p, 50p

* The Kairos Core 100 requires the AT-SF001 4K option.

New Agile I/O expands number of I/O

Input/output functions of KAIROS has been expanded and strengthened by the new "Agile I/O" feature that flexibly allocates GPU I/O capability according to the bandwidth of video source. For example, up to 64 inputs* and 40 outputs* of 1080i and 720p signal can be connected to on a single mainframe with ST2110 network.

This allows using in larger scale live productions with more scenes and more input sources.

KAIROS removes input restriction to be connected to a system and realize more efficient use of ST2110 network and other inputs such as Deltacast, NDI[®], SRT and other streaming inputs.

*The Kairos Core 1000 mainframe offers a maximum 64 inputs and 40 outputs. The Kairos Core 100 mainframe with the AT-SF002 I/O option offers a maximum 48 inputs and 32 outputs. Both are best effort when all input/output sources are 1080/60i or 720/60p video.

Previous I/O
3Gb/s or 12Gb/s per source

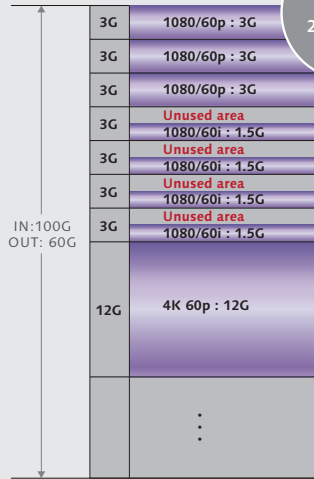

Max.
32 input
20 output
(AT-KC1000)

Agile I/O
Flexible allocation according to source bandwidth



Max.
64 input
40 output
(AT-KC1000)

Agile I/O Outline Diagram, Example in ST2110

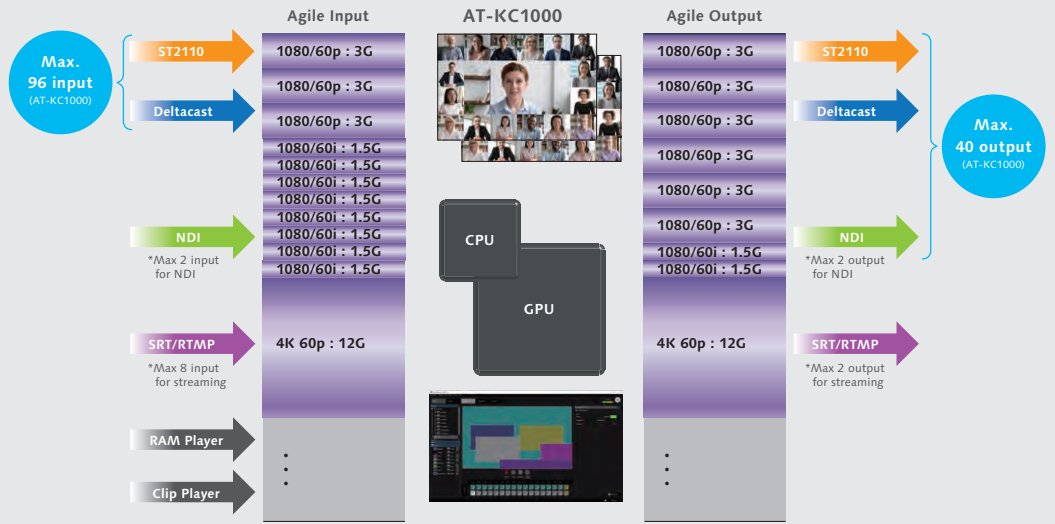

I/O Overview (AT-KC1000)

Maximum Number of I/O

		Kairos Core 1000		Kairos Core 100 (*with I/O option)	
		Connectable CH	Video Processing CH	Connectable CH	Video Processing CH
Input	1080i, 720p	QSFP(ST2110)	64	64	24 (48)
		Gateway Port	32		
		NDI*	2		
	1080p	RTP/SRT/RTMP/RTSP	8	32	6
		QSFP(ST2110)	32		
		Gateway Port	32		
	4K	NDI*	2	8	24 (32)
		RTP/SRT/RTMP/RTSP	8		
		QSFP(ST2110)	8		
Output	1080i, 720p	Gateway Port	8	8	6 (8)
		NDI*	2		
		RTP/SRT/RTMP/RTSP	8		
	1080p	QSFP(ST2110)	40	20	12 (32)
		Gateway Port	2		
		NDI*	2		
	4K	RTP/SRT/RTMP/RTSP	2	5	3 (4)
		QSFP(ST2110)	12 (16)		
		Gateway Port	2		

* with I/O option: Require I/O option AT-SF002 and 4K option AT-SF001 for 4K I/O.

NDI*: max. 2 CH input/2 CH output for both AT-KC1000 and AT-KC100

RTP/SRT/RTMP/RTSP: max. 8 CH input/2 CH output for AT-KC1000, max. 6 CH input/2 CH output for AT-KC100

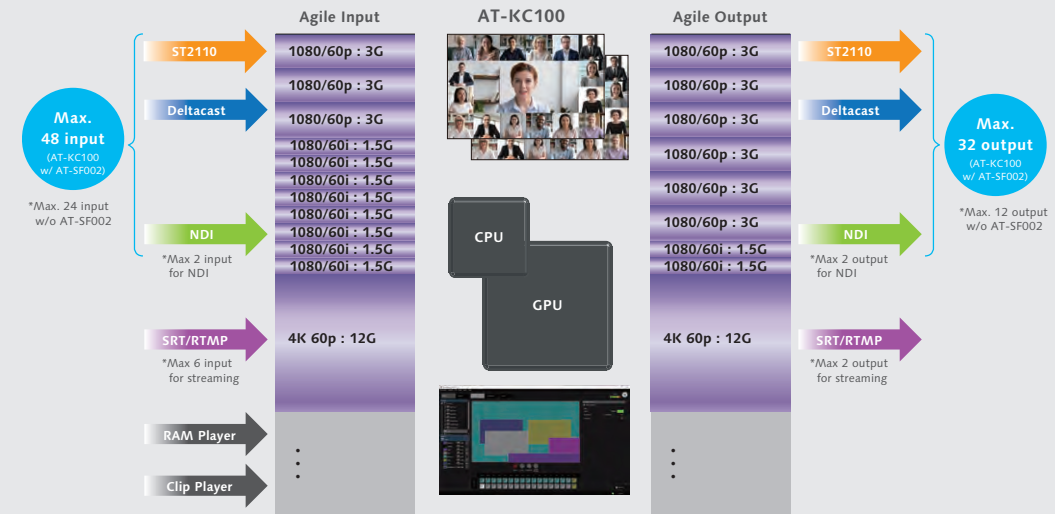

I/O Overview (AT-KC100)



Fully customizable multiviewer

Two customizable multi-viewers configuration

In addition to video inputs and outputs, KAIROS is also equipped with two multi-viewer outputs (Display Port) that are compatible with 4K/HD. The display layout can be freely customized and saved as your own template, and up to 36 screens images can be displayed on two screens. This multi-viewer can also manage to display RAM/Clip Player and scene & AUX output. The audio level meter can also be displayed.

PTP synchronization

KAIROS supports PTP (Precision Time Protocol) synchronization, which is an IP-based synchronization and can fully manage the whole ST2110 systems. Supports PTP synchronization even with a GbE (Gigabit Ethernet) port connection.

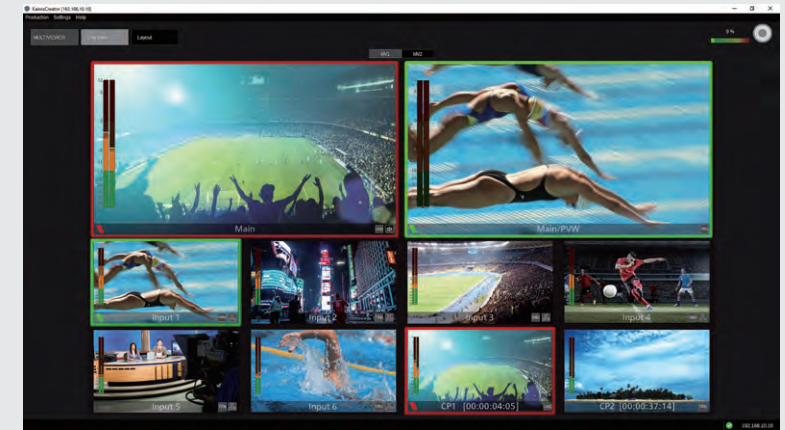

10 split screen with audio level meter displays



Horizontal mode



Vertical mode

Audio input/output supported

In addition to ST2110-30 (AES67), SDI embedded audio via the gateway port, NDI, and SRT/RTMP/RTSP audio input/output are supported. Also, functions that support audio level meter displays onto the multi-viewer, clip player audio output and output audio routing have been added.

These make it suitable for 2110-based environments.

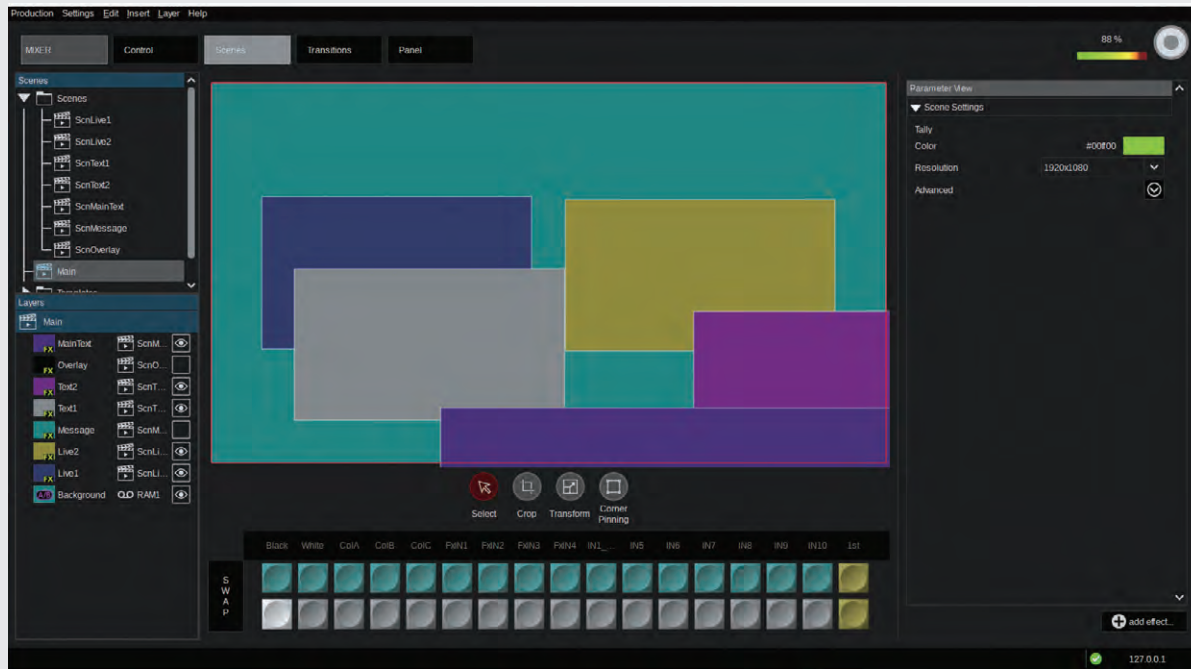

Kairos Creator Scenes menu

Allows you to set each scene* and layer.

* What we call a "Scene" in KAIROS is an extended expression of the traditional "ME" in general switcher. A "Scene" is for source video selection, transitions, and layer compositing like traditional ME but the number of layers, resolution, source video assignments etc., can be freely defined for each "Scene" by the user.

Layered effects with unrestricted number of MEs

Unlike the conventional hardware-based switcher, KAIROS is unrestricted by the number of MEs or keys. Layers can be added as the GPU capacity permits similar to the layers of a standard image-editing app, allowing you to set the keys and scaling freely. The Kairos Core 1000 in particular has significantly increased the number of layers by increasing the GPU video processing capacity to enable more complex and advanced video expressions.

Format-free Canvas

The Canvas function enables the production of videos in a special format, such as 32:9 for wall display, in addition to the standard 16:9 format. Up to 8K (32M pixels) resolution is supported. With the freely customizable multi-viewer, videos with unique aspect can be displayed as is.

*The Canvas function is a standard feature of the Kairos Core 1000. With the Kairos Core 100, the AT-SF003 Canvas option is required, and the AT-SF001 4K option is required for 4K output. In either case, some functions are being depended on the GPU performance level.



Kairos Creator Live View menu

Multi-view videos (MV1/MV2) can be monitored on the GUI software. The image shows an example of a multi-view display that includes 32:9 "Canvas".

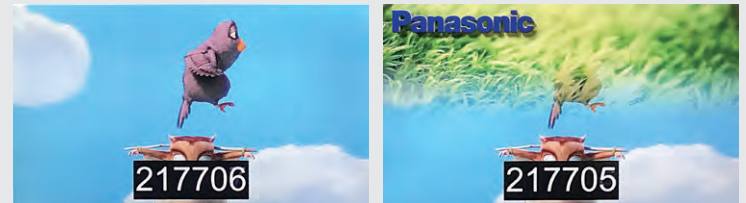

Original

Mix Effected

The KAIROS processing latency can be as low as one frame.

Short one frame latency and variable frame delay

The KAIROS processing latency can be as low as one frame. Sports and concert performances can be presented with the action intact. A variable frame delay (1 to 20 frames per 1 frame step) can be conducted for each channel, and the frame delay difference between the sources can be adjusted.

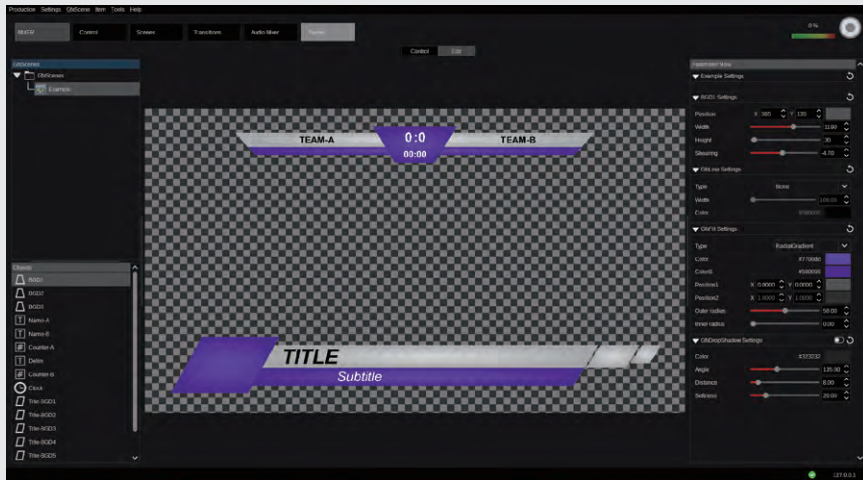

Title Generator menu
You can create a simple title.

Diverse effects with title generator

Layers can be added with not only keys but also various effects. The built-in title generator allows you to create titles.

Audio mixer function

The AT-SF005 audio mixer option adds audio mixing function. It enables the adjustment, mixing, routing and muting of up to 16 channels (stereo/monaural) per video source. It is also equipped with a master level adjustment and tone generator. PFL (Pre-Fader Listen) and audio monitor output are also supported.



Audio mixer

Video/audio/still picture file retention

With the built-in RAM Player, Clip Player and Audio Player, footage can be played loaded video/audio files.* A playlist function has been added to the Clip/RAM player. It also has a still picture storage.

- **RAM Player (8 channels, uncompressed)**
Uncompressed images can be played, making it suitable for playing relatively short videos such as background video loop playback and flying logo. The recording time depends on the RAM capacity of the Kairos Core 1000 and Kairos Core 100, and increases according to the material image resolution and number of channels (up to 8 channels). Clips are imported externally and saved onto the internal SSD.
- **Clip Player (2 channels, compressed)**
It is possible to play compressed video* files with audio, making it suitable for playing relatively long clips such as commercial footage. Clips are imported externally and saved onto the internal SSD. It supports AVC-Intra, H.264, and Avid DNxHD video file formats.
In addition, Apple ProRes** is supported.

ProRes

- **Audio Player (4 channels)**
Audio files can be played. File formats supported are WAV, MP3, Ogg, FLAC and AIFF; files other than WAV will be converted to WAV (48 kHz / 24 bit) upon upload.

* The Kairos Core 100 requires the AT-SF001 4K option during 4K playback.
** Compressed video files with interlaced video format are not supported.
Note: Playing compressed video files depends on video resolution, NLE system by which the video files are made, and performance of Kairos Core CPU. Please confirm video files playback capability with Kairos before starting production.

File storage capacity for video and still images

In/Out	Kairos Core 1000	Kairos Core 100
RAM player	64 GB HD: Approx. 170 sec., 4K: Approx. 42 sec	24 GB HD: Approx. 64 sec., 4K: Approx. 16 sec.
Clip player	180 GB* HD: Approx. 55 min., 4K: Approx. 14 min. *Share capacity with audio player	70 GB* HD: Approx. 21 min., 4K: Approx. 5 min.
Still picture file	12 GB	750 MB
Audio player	180 GB* *Share capacity with clip player	70 MB*

Compressed video recording conditions:
HD: 440Mb/s, 1080/59.94p, 4:2:2/10bit, 4K: 1.63Gb/s, 2160/59.94p, 4:2:2/12bit

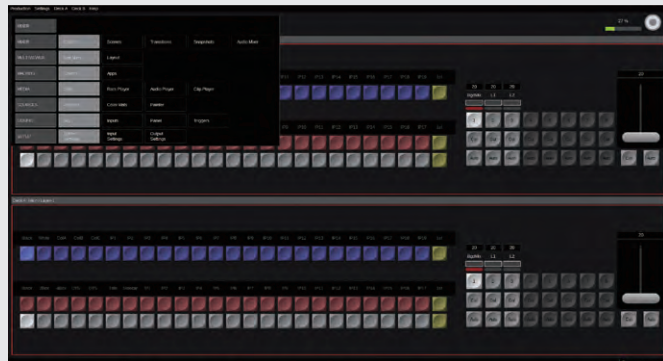

Control menu
Live operation is possible on the GUI software.

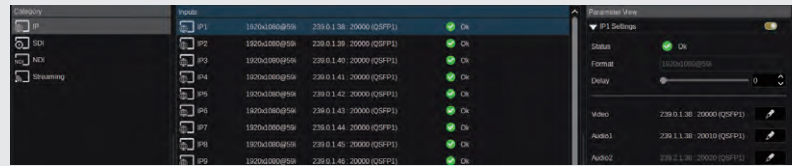

Input Settings menu
Allows you to select the input type (ST2110/SDI/NDI®) and other settings.

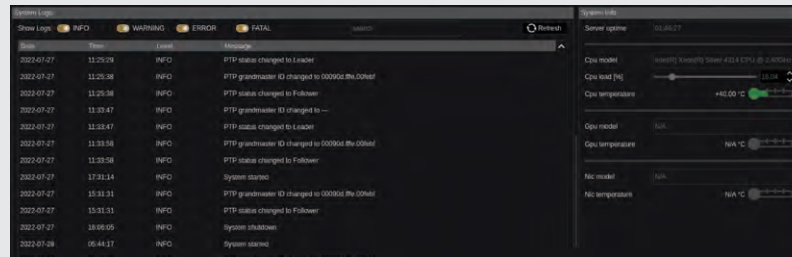

System Logs menu
Check equipment status and operation logs. Requires KAIROS version 1.3.2 or higher.

PC software with intuitive GUI

The “Kairos Creator” PC software (supported with Windows10 and MacOS Catalina, Big Sur) features an easy-to-use intuitive GUI and various settings and operation are possible. It also displays the GUI control panel to make space saving operation possible.

User-assignable control panel

The “Kairos Control” panel allows functions to be assigned freely. Indicators show the functions assigned to individual buttons. Multi-scene operation is supported with two ME layouts and two faders. Multiple panels can be used simultaneously within a single system. Two models are available: 24XPT standard layout (AT-KC10C1) and 12XPT compact layout (AT-KC10C2).

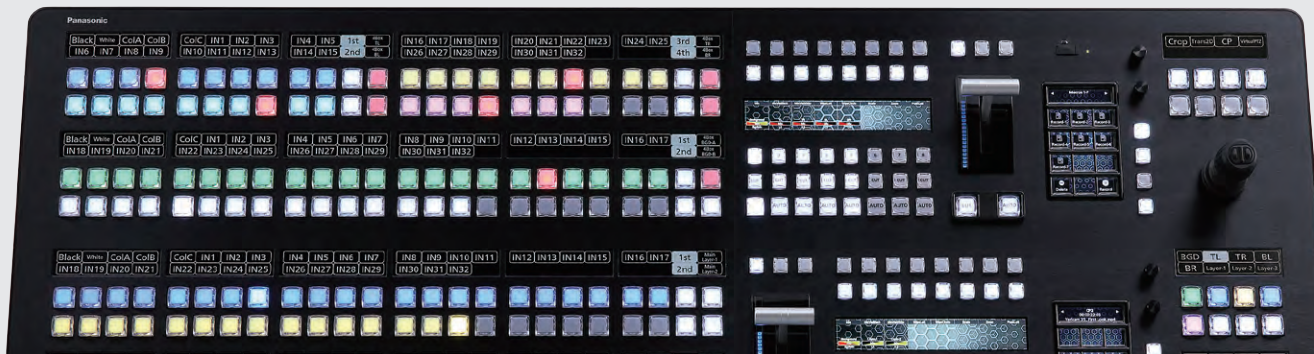

Redundancy function NEW

KAIROS now provides three redundancy functions to further enhance safety: Kairos Core redundancy* for mainframes, ST-2022-7 redundancy* for networks (Kairos Core 1000 only), and redundant power supplies.

*Requires KAIROS version 1.3.2 or higher

System Log function NEW

The System Log records equipment status and operation logs for reference in case of trouble.

Requires KAIROS version 1.3.2 or higher.

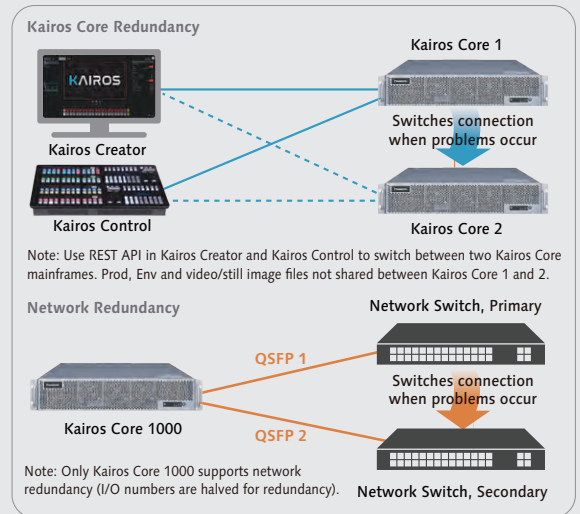

Software-enabled function expandability and linkage

KAIROS is an IT-based open architecture platform, and allows expansion of functions and control of external devices with the additional software to provide high flexibility and expandability. By using various function options, it offers an efficient system design. The support of external protocols is continuously evolving and the flexibility of Kairos will allow future system expansion and integration. RossTalk protocol is supported by KAIROS version 1.3.2 or higher (optional AT-SFE01 Software Key) for controlling Ross XPression real-time motion graphics. NEW

Ross and XPression are registered trademarks of ROSS Video.

Hardware/Software

AT-KC1000

Kairos Core 1000
(Main Frame)
2 RU size

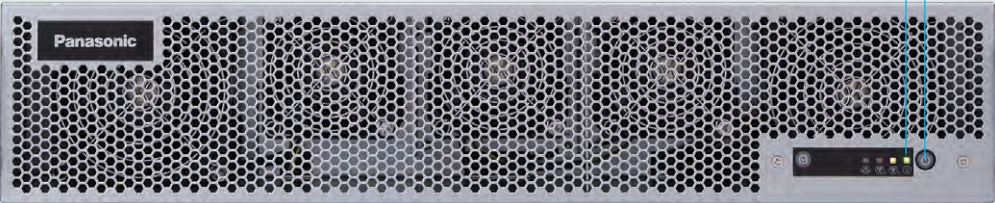

Power switch
Power status LED

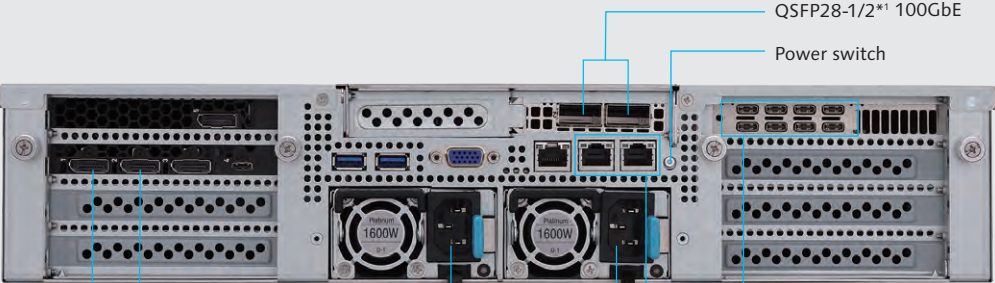

MV1/MV2
(Display port Version 1.4, for multi-view output)

AC IN

Gateway port for Deltacast

LAN 1/2 RJ-45 1GbE

QSF28-1/2*1 100GbE

Power switch

AT-KC100

Kairos Core 100
(Main Frame)
1 RU size



Power switch
Power status LED



MV1/MV2
(Display port Version 1.4, for multi-view output)

AC IN

Gateway port for Deltacast

QSF28-1/2* 100GbE

LAN 1/2 RJ-45 1GbE

* The QSF28-2 will be supported in the future.

AT-KC10C1

Kairos Control (Control Panel) Standard Type

Two faders with 24XPT layout, all elements user assignable and multi control with joystick.



AT-KC10C2 NEW

Kairos Control (Control Panel) Compact Type

Two faders with 12XPT layout and compact panel suitable for on-location venues and OB vans use.



AT-KC10C2 requires KAIROS version 1.3.2 or higher.

Scene control block, top

Transition control block, top

Multi select block, top

Multi-function block with joystick



Scene control block, bottom

Transition control block, bottom

Multi select block, bottom

Scene control block, top

Transition control block, top

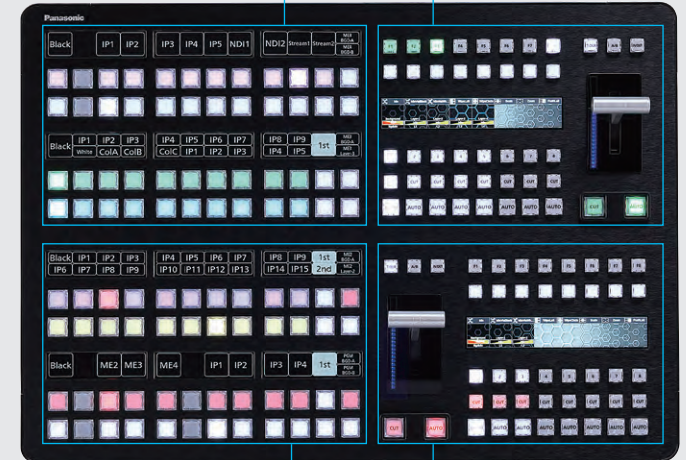

Scene control block, bottom

Transition control block, bottom

Rear Panel Terminals



LAN RJ-45 1GbE

Power 1: DC IN 12V and power switch

Power 2: DC IN 12V and power switch

Rear Panel Terminals



Power 2: DC IN 12V and power switch

Power 1: DC IN 12V and power switch

LAN RJ-45 1GbE

IT/IP Platform "KAIROS" enables new "Smart Studio" concept

"KAIROS" is an open-architecture, software-based live video production platform. The Kairos Core (Main Frame) fully supports base bands, such as SDI, ST 2110 and NDI*, and IP packet input and output. It is not subject to restriction by resolution or aspect ratio. KAIROS also supports remote production and full IP-based environments. Processing of effects/mixing is not restricted by the number of MEs or Keys, unlike a conventional switcher, and as many layers as the GPU power permits can be overlaid. Furthermore, the KAIROS processing latency can be as low as one frame. Kairos Creator (GUI Software) is designed for easy, intuitive operation, while Kairos Control (Control Panel) allows for flexible customization of the layout to contribute to space saving and improved operational efficiency. KAIROS does not require many dedicated devices, software, cables or conversion tools, which the conventional system needs, so it enables the creation of a simple, flexible and space-saving video production studio.

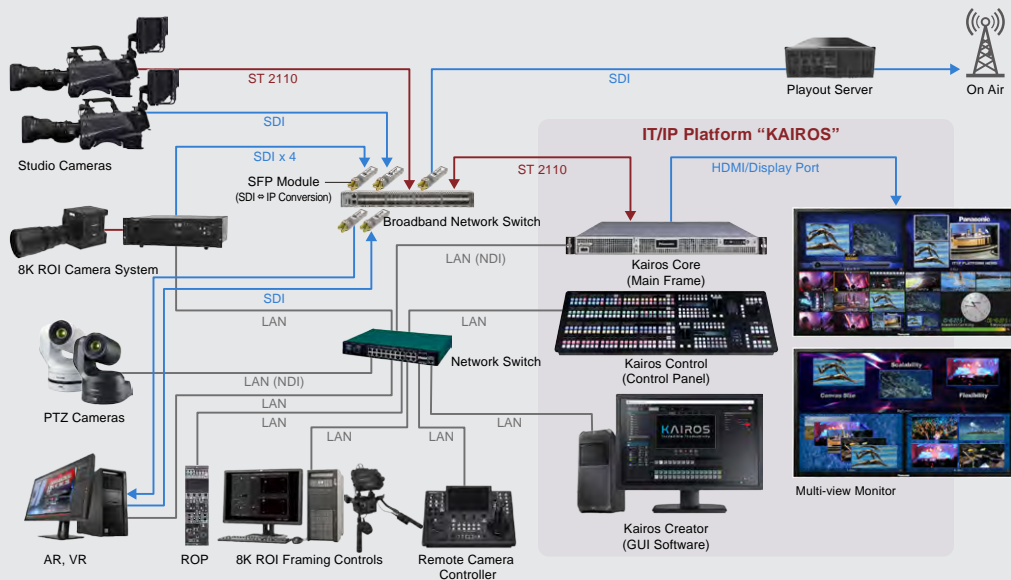

Integrated management of multi-camera recording, large screen displays and stage production

The IT/IP Platform "KAIROS" is a solution for improving IT/IP-based live video production, such as live concert recording. KAIROS fully supports base bands, such as SDI, ST 2110 and NDI*, and IP packet input and output. Its operation is not restricted by the resolution or aspect ratio, so it can handle special aspect ratios such as 32:9 for wall displays. KAIROS is capable of simultaneously outputting video signals suitable for a variety of image display systems. All those operations can be integrally managed. When combined with PTZ cameras, KAIROS simplifies the equipment to use and reduces the number of operators and the setup space. It helps achieve smart management that contributes to efficient live event/video production.

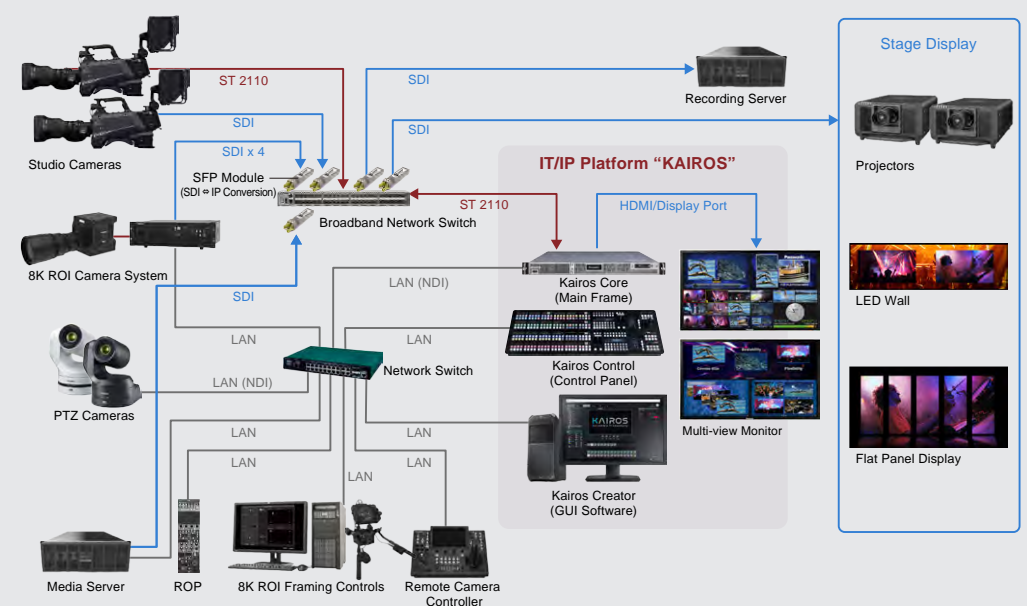

* NDI* is a new protocol developed by NewTek, Inc. that supports IP video production workflow. NDI* is a registered trademark of NewTek, Inc. in the United States. In this instance, NDI* is used to indicate low latency with high bandwidth ND*.

Live streaming using KAIROS was demonstrated at the Olympic and Paralympic Games Tokyo 2020.

Japan, 2021 – The Olympic and Paralympic Games Tokyo 2020 was staged over 30 days under the slogan “United by Emotion.” In addition to equipment provision, Panasonic committed holistic on-site support to the Tokyo 2020 Games with expertise demonstrated through on-site video distribution and security system support at about 50 competition venues. Rowing and canoeing events at Sea Forest Waterway provided an opportunity for Panasonic to demonstrate KAIROS live video-production platform, introducing next-generation infrastructure based on IT/IP. It contributed to high-resolution video display via LED large-screen display systems and supported video-editing including PinP and logo insertion.



LiveX upgrades new 4K broadcast streaming studio with Panasonic KAIROS

United States, 2021 – Seeking a solution that would up level the quality of its productions and provide greater flexibility, LiveX purchased Panasonic's KAIROS, a next generation IT/IP live production platform. The full-service production and broadcast company, whose previous work includes the Democratic National Convention and USGA U.S. Open Championship, will use the platform to automate its new 4K broadcast streaming studio and expand the company's remote capabilities for future productions.



“Remote broadcasting has been a part of our business for the last four years, so it's really in our DNA to have remote production capabilities,” said Corey Behnke, co-founder and producer and at LiveX. “Panasonic's KAIROS platform was the first system we saw where everything works together in tandem and provides us with the ability to remotely control everything from anywhere in the world.”

IFM implements UHD VR Studio to produce and broadcast content – no matter the circumstances

Germany, 2021 – ifm electronic GmbH in Essen, Germany, built a VR UHD TV Studio on their premises to be able to independently produce and broadcast their own content. The studio infrastructure is based on the combination of the ST 2110-based IT/IP-based video processing platform “KAIROS” from Panasonic, the studio production automation “CamBot” and the groundbreaking VR studio system “Reality”. The system, designed for ST 2110, NDI and SRT signal processing and implemented with 3 robotic VariCamLT cine cameras and PTZ Cameras, offers the possibility of realising complete TV productions with a small amount of operators through the usage of the CamBot production automation system.



For more information on KAIROS case studies, please visit the website:
https://pro-av.panasonic.net/en/products/it_ip_platform/#casestudies



KAIROS Software



AT-SFC10
 Kairos Creator
 (GUI Software/Software Key)
 OS: Windows10, MacOS (Catalina/Big Sur)
 For various settings and operations

AT-SF001
 4K Option (Software Key)

AT-SF002
 I/O Option (Software Key)

AT-SF003
 Canvas Option (Software Key)

AT-SF005
 Audio Mixer Option (Software Key)

AT-SFE01 NEW
 RossTalk option (Software Key)
 RossTalk supported for controlling XPression real-time motion graphics.
 Ross and XPression are registered trademarks of ROSS Video.

AT-SFE03
 NMOS Option (Software Key)
 NMOS (Networked Media Open Specifications) is a protocol standardized by AMWA (Advanced Media Workflow Association) for controlling and managing devices via IP networks.

More options will be available in the future. For more information, please refer to the following web page

KAIROS Alliance Partners

KAIROS uses infinitely expanding IT ecosystems to easily expand functions with the additional software and linkage of external devices. In order to accelerate this linkage, Panasonic promotes collaborations with IT companies, video equipment manufacturers and suppliers.



https://pro-av.panasonic.net/en/support/kairos_partners.html



	AT-KC1000 Kairos Core 1000 (Main Frame)	AT-KC100 Kairos Core 100 (Main Frame)
General		
Power Requirement	AC 100 V - 127 V/200 V - 240 V, 50 Hz/60 Hz, 12 A/9 A (Redundant)	AC 100 V - 240 V, 50 Hz/60 Hz, 8 A - 4 A (Redundant)
Operating Temperature	5 to 35 degree Celsius	
Operating Humidity	10% to 90% (no condensation)	
Weight	Approx. 17.4 kg / 38.36 lb (body only)	Approx. 10.6 kg / 23.36 lb (body only)
Dimensions (W x H x D)	438 mm x 88 mm x 620 mm / 17.2 in. x 3.5 in. x 24.4 in. (Excluding protrusion)	438 mm x 43.5 mm x 621 mm / 17.2 in. x 1.7 in. x 24.4 in. (Excluding protrusion)
Video/Audio/Synchronous		
Support Video Format	4K: 3840 x 2160/60p, 59.94p, 50p, 30p, 29.97p, 25p, 24p, 23.98p (Kairos Core 100 requires AT-SF001 4K option) FHD: 1920 x 1080/60p, 59.94p, 50p, 30p, 29.97p, 25p, 24p, 23.98p 1920 x 1080/59.94i, 50i HD: 1280 x 720/60p, 59.94p, 50p	
Signal Processing	Y/PB/PR: 4:2:2 10 bit	
Audio Format	ST2110-30 (AES67): 48 kHz/24 bit	
Synchronous		
PTP Sync	Support for QSFP and GbE port	
FS (Frame Synchronize)	For each CH, always ON (can't turn off)	
Frame Delay	0 frame to 12 frame, 1 frame step	
I/O Specification		
IP	QSFP: QSFP28 x 2, 100GbE (ST2110, PTP sync) LAN: RJ-45 x 2, 1GbE (Control system, PTP sync, NDI®, RTP/SRT/RTMP/RTSP)	
Baseband	Display Port: Display Port 1.4 x 2, for Multiview output Gateway Port: Custom Interface Connectors x 8, for Deltacast FLEX modules SDI: 12G-SDI, 3G-SDI x 3, Use of recommended products* 3G-SDI x 4, Use of recommended products* HDMI: HDMI 2.0 x 1, Use of recommended products* Display Port: Display Port 1.2 x 1, Use of recommended products*	
Number of inputs and outputs and number of channels that can be used simultaneously	See "Maximum Number of I/O" on page 5.	
Accessories		
Accessories:	Accessories: AC cable x 2 (Cable types vary by region), Rack-mounted slide rail: 1 set with screws	

*Recommended product: Deltacast FLEX module

AT-KC10C1 Kairos Control (Control Panel)

General	
Power Requirement	DC 12 V, 8.0 A (Redundant)
Operating Temperature	0 to 40 degree Celsius
Operating Humidity	10% to 90% (no condensation)
Weight	Approx. 15.4 kg / 33.95 lb
Dimensions (W x H x D)	1140 mm x 94 mm x 420 mm 44.9 in. x 3.7 in. x 16.5 in. (Excluding protrusion)
Control Terminals	
LAN (Rear Panel)	RJ-45 x 1, 1GbE
USB (Control Panel)	USB 2.0 type A x 1
USB (Rear Panel)	USB 2.0 type A x 1

AT-KC10C2 Kairos Control (Control Panel)

General	
Power Requirement	DC 12 V, 4.0 A (Redundant)
Operating Temperature	0 to 40 degree Celsius
Operating Humidity	10% to 90% (no condensation)
Weight	Approx. 8.5 kg / 18.74 lb
Dimensions (W x H x D)	600 mm x 90 mm x 420 mm 23.7 in. x 3.5 in. x 16.5 in. (Excluding protrusion)
Control Terminals	
LAN (Rear Panel)	RJ-45 x 1, 1GbE
USB (Rear Panel)	USB 2.0 type A x 1

Dimensions

AT-KC1000
Kairos Core 1000 (Main Frame) unit:
unit: mm

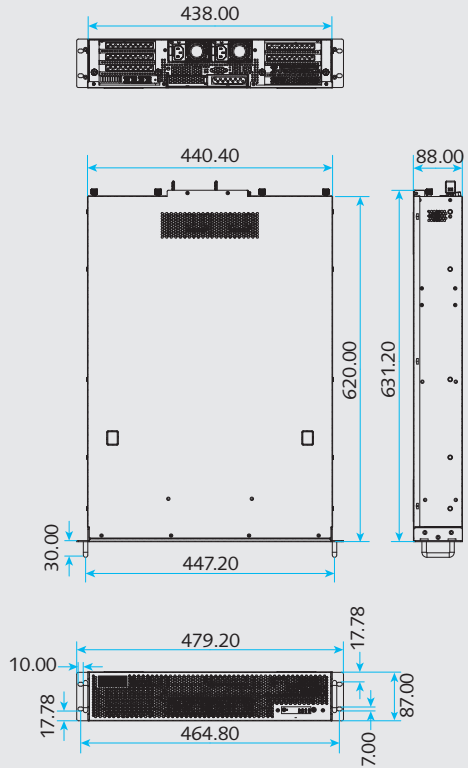

AT-KC100
Kairos Core 100 (Main Frame) unit:
unit: mm

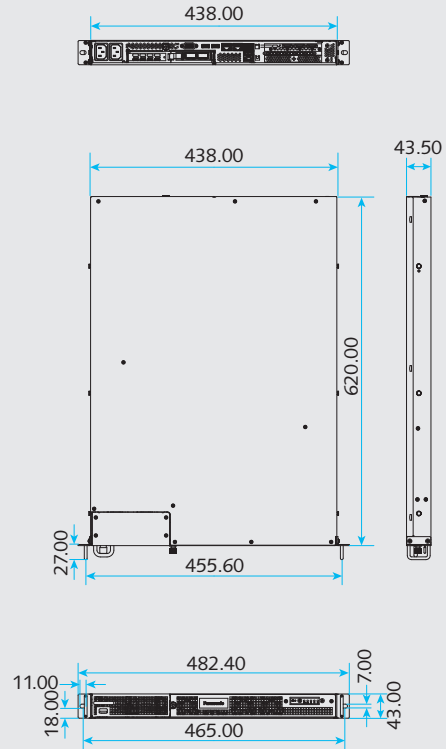

AT-KC10C1
Kairos Control (Control Panel) unit:
unit: mm

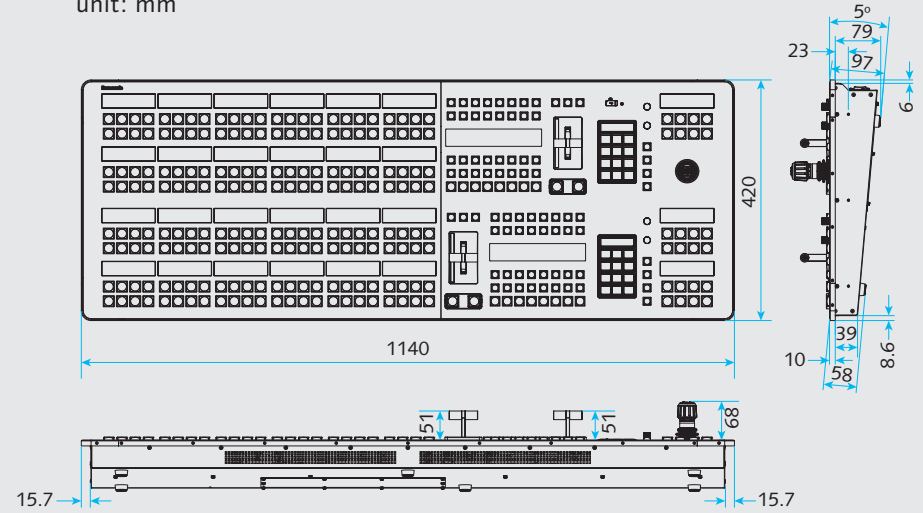

AT-KC10C2
Kairos Control (Control Panel) unit:
unit: mm

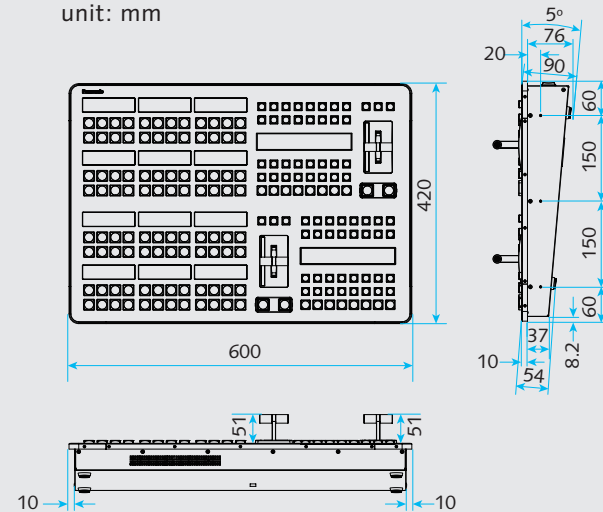

Panasonic®

Panasonic Connect Co., Ltd.
2-15 Matsuba-cho, Kadoma, Osaka 571-8503 Japan

SP-KAIROSPE4WEB



Factories of Panasonic Connect Co., Ltd. have received ISO14001:2015-the Environmental Management System certification. (Except for 3rd party's peripherals.)



For more information, please visit
Panasonic web site
<https://pro-av.panasonic.net/en/qr/>

KAIROS

Incredible Productivity

https://pro-av.panasonic.net/en/products/it_ip_platform/



*Specifications are subject to change without notice. 202210Z-1