

## Operating Instructions Multi Monitoring & Control Software

Multi Monitoring & Control Software 3.4

### Windows

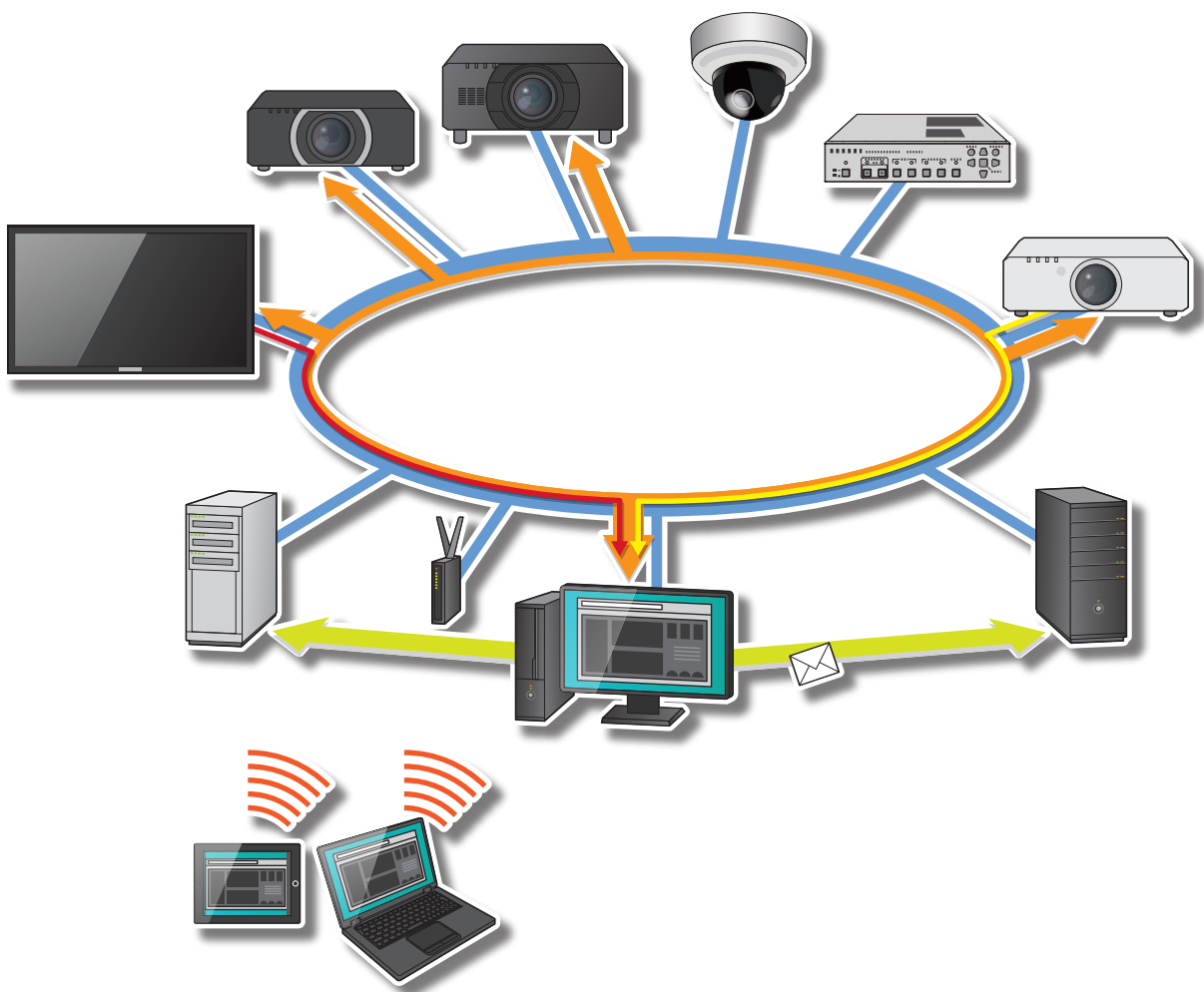

Thank you for purchasing this Panasonic product.

■ Before using this software, please read the instructions carefully.

# Contents

<b>Introduction.....</b>	<b>4</b>	<b>Monitoring Function.....</b>	<b>77</b>
Software Licensing Agreement .....	4	About the Brief Information Display.....	77
Request Regarding Security .....	6	Detailed Information Display .....	89
About this document .....	8	Display network camera video .....	91
Terms used in this document .....	8	Display the image input into the device...	93
What You can do with this Software .....	10	Displaying the Simple System History	
<b>Preparation.....</b>	<b>15</b>	Information .....	96
System Requirements .....	15	Displaying the ECO Power Level	
Network Configuration.....	17	Monitor .....	99
Steps to Start Operation.....	19	Saving a Maintenance Log.....	102
Installing the Software on the		Saving the Information of a Registered	
Monitoring and Control Terminal .....	20	Device .....	105
Before Using this Software.....	25	<b>Controlling Devices.....</b>	<b>112</b>
Setting early warning function .....	26	Executing a Control Command .....	112
Uninstalling the software .....	36	Scheduling Function.....	122
<b>Registering a Device to Monitor and</b>		Controlling Devices by Selecting	
<b>Control.....</b>	<b>37</b>	Commands to be Sent	
About the <Device Monitoring>		([Operation Settings]) .....	125
Window .....	37	Configuring Devices by Entering	
Registering Devices and Peripheral		Commands ([Command Settings]).....	126
Devices to Monitor and Control .....	39	Configuring a Command List	
Changing the Registration Information		([Command list Settings]).....	128
of a Device or Peripheral Device.....	52	Delivering/Deleting Images	
Changing the Device Name .....	53	([Simultaneous image distribution] /	
Register a network camera .....	54	[Distribution image deletion]) .....	130
Changing the Registration Information		Delivering Images by Interruption	
of a Network Camera .....	57	during Signage Playback	
Setting up the Fail Soft Function .....	58	([Interrupting delivery]) .....	139
Creating a Group.....	60	Caption distribution/stop	
Creating a Keyword.....	62	([Distribute captions]/	
Creating Brightness Control .....	65	[Stop caption distribution]).....	143
Updating Device Registration		Adjusting Brightness on a per-Screen	
Information .....	68	Basis ([Brightness Control]) .....	151
Deleting (A device, group, keyword,		Creating a List to Distribute Images	
brightness control, or network camera)...	71	([Delivering contents list]).....	154
Registering Device Location		Calling the Web Control Window.....	168
Information .....	72	Calling the Geometry Manager Pro.....	171
		Calling the Content Manager .....	172
		Acquiring and Delivering a Signage	
		Schedule .....	173
		Delivering the master device data all at	
		once .....	177

**Using the Early Warning Function... 180**

- Confirming the Status of Devices and Peripheral Devices ..... 180
- Confirming Device and Peripheral Device Status (Detail Screen) ..... 183
- Displaying a List of Registered Devices (Overview screen) ..... 191
- Confirming Device History Information ([History (All Device)]) ..... 196
- Controlling Devices ([Control]) ..... 199
- Displaying Error/Warning and Notice Details ..... 200
- Checking the Maintenance Timing ..... 211
- Confirming Device Temperature and Voltage Information ..... 219

**Setting the Monitoring and Control functions ..... 228**

- Setting the Monitoring and Control's option function ..... 228
- Setting the Information Updating Interval ..... 229
- Setting the Number of System History Entries that can be Saved ..... 230
- Setting the Port Number for Command Control ..... 232
- Setting the Status Notification Function ..... 233
- Changing the Information Displayed on the Information Display Windows ..... 234

**Setting up the Early Warning Function ..... 235**

- Setting the Early Warning Function of Monitoring and Control ..... 235
- Setting SNMP Notifications ..... 236
- Configuring the Required Settings for Sending Mail ..... 239
- Setting a Warning to Report that a Device is Not Connected ..... 243
- Updating Notification Data ..... 245
- Registering, Deleting and Changing User Account Control ..... 247
- Making Video Stop Determination Settings for a Network Camera ..... 251

**Other Questions & Answers ..... 252**

- Error Messages ..... 252
- Frequently Asked Questions ..... 256
- Trademarks ..... 269

# Introduction

---

## Software Licensing Agreement

Use of this software is governed by the terms defined in this “Software Licensing Agreement”. By using this software, you are agreeing to the “Software Licensing Agreement”.

### **1. License**

This license grants Licensee the right to use the Software, but does not transfer to Licensee any patent rights, copyrights, or any other rights, which remain the property of Panasonic Connect Co., Ltd. or third parties. Licensee may use the Software only for the purpose of managing Panasonic displays (projectors and flat panel displays). Note that the usage rights licensed to Licensee by downloading the Software include separate restrictions limiting the period of use and the number of displays (projectors and flat panel displays) that can be used.

### **2. Use by a Third Party**

Licensee may not transfer or allow any third party, to use or copy the Software, whether free of charge or not.

### **3. Restrictions on Copying the Software**

Licensee may make one copy only of the Software in whole or in part solely for backup purposes.

### **4. Computer**

The Software is for use on one computer owned or managed by Licensee and may not be used on other computers.

### **5. Reverse Engineering, Decompiling or Disassembly**

Licensee may not reverse engineer, decompile or disassemble the Software. Panasonic Connect Co., Ltd. shall not be bound by warranty for any defects in the Software caused by reverse engineering, decompiling or disassembly of the Software.

Furthermore, Panasonic Connect Co., Ltd. or its distributors or dealers will not be responsible for any damage to the Licensee caused by the reverse engineering, decompiling or disassembly of the Software.

## Software Licensing Agreement

---

### **6. After-sales Service**

Panasonic Connect Co., Ltd. shall undertake to notify Licensee of whether the problem is a known error in the program ("bug"), or whether the way in which the Software is to be used should be modified. However, no after-sales service will be carried out for problems caused by use of the Software for purposes other than managing Panasonic displays (projectors or flat panel displays). Furthermore, the specifications Software is subject to revision without prior notice.

### **7. Indemnification**

Panasonic Connect Co., Ltd.'s responsibility for the Software shall not exceed the terms set forth in Section 6 above. Panasonic Connect Co., Ltd. and its distributors and dealers shall assume no responsibility for any direct or indirect damages or losses incurred by Licensee or third party claims against Licensee in connection with the use or failure of the Software. Note that the purpose of the Software is to support management of Panasonic displays (projectors and flat panel displays). Panasonic Connect Co., Ltd. and its distributors and dealers do not guarantee the adequacy of the Software, the accuracy of its results, or its fitness for Licensee's specific purpose, nor do they guarantee that the Software does not infringe on the rights of third parties. Furthermore, please note that Panasonic Connect Co., Ltd. and its distributors and dealers cannot assume responsibility for any problems that occur when downloading files.

### **8. Export Control**

If the Licensee brings the software to another Country other than the Country of purchase, The Licensee will follow the regulations of that Country regarding export management.

### **9. Governing Law and Changes to this Notice**

All aspects of the use of this software shall be governed by and interpreted under the laws of Japan. Panasonic Connect Co., Ltd. may change this notice at its own discretion without notifying Licensee.

### **10. Agreed Jurisdiction**

In the event of a need for litigation concerning the use of the Software, Licensee and Panasonic Connect Co., Ltd. may file an action in Osaka District Court only.

---

## Request Regarding Security

**Be aware of the following security risks when using this software.**

- Leakage of your private information via this software
- Illegal operation of this software by a malicious third-party
- Harm to or cessation of operation of this software by a malicious third-party

**Be sure to implement sufficient security measures.**

- Make sure the password is as hard to guess as possible.
- Change the password periodically.
- Panasonic Connect Co., Ltd. and its affiliated companies never directly ask customers for their password. Do not give out your password even if directly asked by a third-party representing themselves as Panasonic Connect Co., Ltd.
- Regularly run Windows Update to keep the operating system on the computer up-to-date.
- Always use on a network that has safety protection such as a firewall implemented.
- Set passwords, and limit the users that are permitted login access.

## Request Regarding Security

---

### **Security warnings regarding the usage of Wireless LAN products**

The advantage of a wireless LAN is that information can be exchanged between a PC or other such equipment and an access point using radio waves as long as you are within range for radio transmissions.

On the other hand, because the radio waves can travel through obstacles (such as walls) and are available everywhere within a given range, problems of the type listed below may occur if security-related settings are not made.

- **Interception of communication**

A malicious third party may intentionally intercept wireless communications and see their contents, including possibly:

- Personal information such as IDs, passwords, and credit card numbers
- The contents of email messages

- **Unauthorized access**

A malicious third party may access the individual's or company's internal network without permission and carry out actions such as the following:

- Retrieve personal and/or secret information (information leak)
- Spread false information by impersonating a particular person (spoofing)
- Overwrite intercepted communications and issue false data (tampering)
- Spread harmful software such as a computer virus and crash your data and/or system (system crash)

Since most wireless LAN cards or access points are equipped with security features to take care of these problems, you can reduce the possibility of these problems occurring when using this product by making the appropriate security settings for the wireless LAN device.

Some wireless LAN devices may not be set for security immediately after purchase. To decrease the possibility of occurrence of security problems, before using any wireless LAN devices, be absolutely sure to make all security-related settings according to the instructions given in the operation manuals supplied with them.

Depending on the specifications of the wireless LAN, a malicious third-party may be able to break security settings by special means.

Please contact your dealer if you need help taking care of security settings or other such.

Panasonic Connect Co., Ltd. asks customers to thoroughly understand the risk of using this product without making security settings, and recommends that the customer make security settings at their own discretion and responsibility.

## About this document

- Although a tablet can be used instead of a computer for the client function, the descriptions in the operating instructions assume the use of a desktop computer.
- Depending on your environment and settings, your screen may not match the screens shown in the operating instructions.
- For information about the operation of your computer, Windows operating system and the various routers, please see their respective instruction manuals.
- In this document, “(page X)” indicates a page to be referenced.
- The contents of this document are subject to change without prior notice.
- Unauthorized reproduction of the contents of this document in whole or in part is prohibited.
- Names of menus, tabs, buttons and strings in screens are given in square brackets ([ ]).
- Arrows (→) are used to indicate selection of a submenu from a higher-level menu.
- There is no categorization between a user account and administrator account for a Panasonic Connect Co., Ltd.'s Media Processor FMP Series account. The set account can be used as an administrator account.

## Terms used in this document

### Device

“Device” refers to a Panasonic display device (projector or flat panel display).

### Peripheral device

“Peripheral device” refers to a network camera or DIGITAL LINK Switcher connected to the same network as a device.

- You can register a network camera on its own or by linking it to a device. When you link it to a device you can check the video displayed by the device or perform stop determination of videos. Furthermore, you can register a DIGITAL LINK Switcher by linking it to a device to check the input/output condition and fan condition of the DIGITAL LINK Switcher connected to the device.

### Early warning function

A function to monitor the status of displays and their peripheral devices on the intranet in order to detect early warning signs and issue error notifications.

### Server function

The monitoring and control functions that run on the computer (monitoring and control terminal) on which this software is installed.



## Terms used in this document

---

### **Client function**

The early warning function, which can be operated by using a web browser.

### **Activation**

The act of enabling the early warning function by purchasing a license and activating the software.

### **DHCP (Dynamic Host Configuration Protocol) server**

A server that automatically issues an IP address and other required information to a computer that is temporarily connected to the network.

### **PASS**

The Panasonic Professional Display and Projector Technical Support Website.

PASS manages licenses for the early warning function, which means you must log in to PASS to activate it. For details, please visit the following websites.

<https://panasonic.net/cns/projector/pass/>

<https://panasonic.net/cns/prodisplays/pass/>

### **SNMP (Simple Network Management Protocol)**

A protocol for monitoring and controlling communication equipment connected to the TCP/IP network over the network. SNMP consists of an SNMP manager on the management side and SNMP agents on the managed side. A notification sent from an SNMP agent to an SNMP manager is called an “SNMP trap”.

## What You can do with this Software

The purpose of this software is to centrally manage the equipment located in a particular network, for example in a school or company. The software makes it possible to monitor and display the status of multiple devices and their peripheral devices on the intranet and to issue error notifications.

In addition, the early warning function can not only detect early warning signs and issue error notifications after an error has occurred, but also issue notifications about scheduled maintenance such as cleaning and parts replacement.

You can even use a Web browser on your tablet or laptop computer to check the status of Devices and their peripheral devices from a remote location inside the intranet.

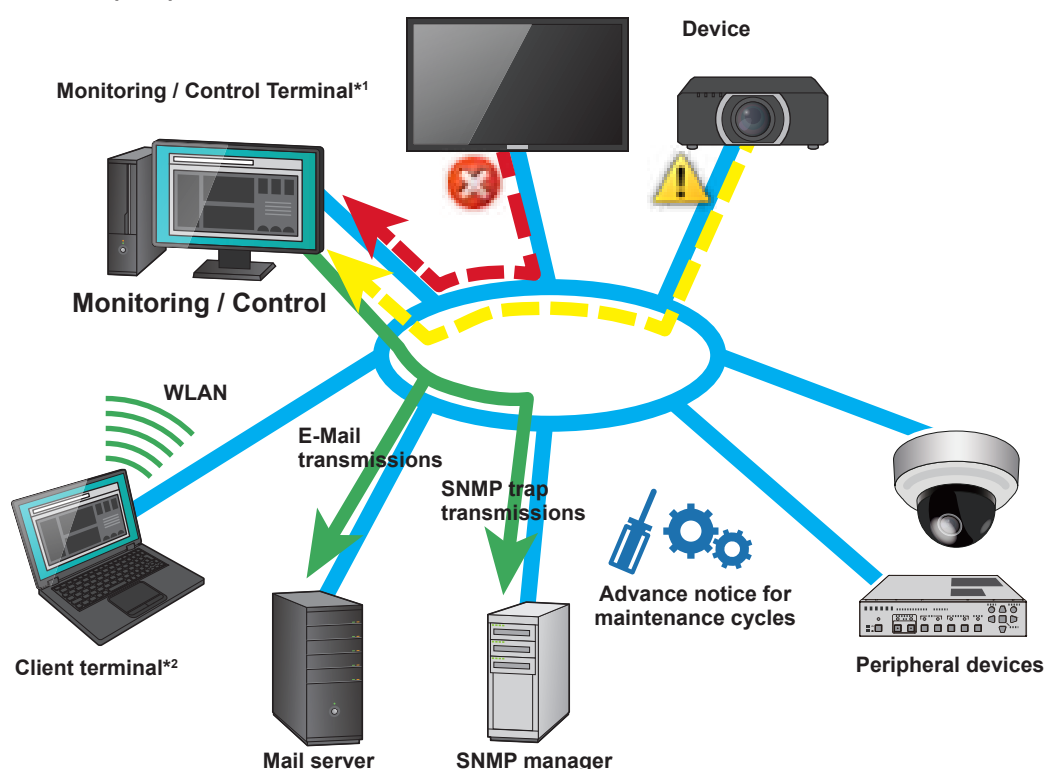

\*1 The computer on which this software (Multi Monitoring & Control Software) is installed.

\*2 On a tablet or laptop computer, a Web browser can be used to access the monitoring and control terminal and check the status of the devices and their peripheral devices.

### Notes

- Please note that the software cannot predict the breakdown of devices and their peripheral devices in all instances. Also, the details displayed in an error notification will differ depending on the device or peripheral device.
- For the devices and peripheral devices compatible with this software, please check this application software which is posted on the following website.  
<https://panasonic.net/cns/projector/download/application/>  
<https://panasonic.net/cns/prodisplays/download/software/>

## What You can do with this Software

---

# Monitoring and control functions

---

This section describes the main functions that are carried out from the monitoring and control terminal.

The early warning function can be added by activating it. (page 13)

## ■ Registering and updating devices

### Register device (page 39)

You can register devices that have been connected to the intranet. (Maximum of 2,048)

- Add a new device (page 39)
- Update registered information (page 52)
- Register peripheral device
  - Network camera (page 54)
  - DIGITAL LINK Switcher (page 39)
- Create group (page 60)
- Create keyword (page 62)
- Create brightness control for a group (page 65)

### Update firmware (page 85)

Simultaneous multiple device updates can be done onto the firmware of a registered device using a firmware update tool.

### Update device information (page 68)

If the IP address of a connected device is being used by another registered device, an icon appears indicating that the device was not recognized due to a mismatch with the registered information. In this case, you may continue to use the device by updating its registration information.

### Manage location information (Map UI) (page 72)

You can manage the placement of devices on a per-group basis.

- Control device (page 75)
- Register schedule (page 75)

## ■ Confirming the status of devices and peripheral devices

### Monitoring (page 77)

You can display and monitor the status of devices and peripheral devices.

- Brief information display (page 77)
- Detailed information display (page 89)
- Network camera image display (page 91)
- Display an image input into a device (page 93)
- Error display (page 96)

## What You can do with this Software

---

### Linking with other application softwares

You can call up installed applications from this software.

- Geometry Manager Pro (page 48, 171)
- Exporting for Screen Transfer (page 50)
- Exporting for Smart Projector Control App (page 50)
- Web Control Function (page 168)
- The Content Manager of the projector (page 172)
- Setting screen of the network camera body (page 91, 202)

## ■ Controlling devices

### Execute control command (page 112)

You can control multiple devices at once (power off/on, input switching, etc.).

### Scheduling function (page 122)

The following functions can be executed at a specified date and time.

- [Operation Settings] (page 125)
- [Command Settings] (page 126)
- [Command list Settings] (page 128)
- [Simultaneous image distribution] (page 130)
- [Distribution image deletion] (page 130)
- [Interrupting delivery] (page 139)
- [Distribute captions] (page 147)
- [Stop caption distribution] (page 149)
- [Brightness Control] (page 151)
- [Delivering contents list] (page 154)

### Acquiring and Delivering a Signage Schedule (page 173)

This function allows you to acquire the signage schedule configured for a projector and then deliver the signage schedule to multiple other projectors.

## ■ Managing and configuring information

### Display system history information (page 196)

The status information (errors, warnings and notifications) and history for all devices registered in the monitoring and control terminal are displayed.

### Set up the early warning function (page 235)

The settings for the early warning function are configured on the monitoring and control terminal.

### Notes

- Functions and settings that can be used differs depending on the model of the device. For the supported functions for each device model, refer to the “List of Compatible Device Models” of this application software which is posted on the following website.  
<https://panasonic.net/cns/projector/download/application/>  
<https://panasonic.net/cns/prodisplays/download/software/>

## What You can do with this Software

---

### **Early warning function**

---

The function can be added by purchasing a license and activating the software. This function can be run on the monitoring and control terminal where this software is installed, or remotely by logging in from a web browser.

#### **■ Performing activation (on the monitoring and control terminal)**

##### **Activating (page 28)**

Activate the license to enable the early warning function. Once the early warning function is enabled, you can access the monitoring and control terminal from a web browser.

#### **■ Check the status of devices and peripheral devices (on the client terminal)**

##### **Early warning monitoring (page 180)**

This function provides details on the cause and what measures to take when a device generates errors and warnings. It also gives advance warning when a part (specific parts) used in a device is likely to break down and when part maintenance should be performed based on customer usage.

##### **History display (page 196)**

Shows the history of past errors, warnings, and notification details.

##### **Device temperature/voltage display (page 219)**

Allows you to view the internal temperature and voltage status of devices.

##### **DIGITAL LINK Switcher status check function (page 188)**

Allows the input/output condition and fan condition of a DIGITAL LINK Switcher to be checked.

##### **Network camera video display (page 202)**

You can use a camera to remotely view the image being displayed by a device.

##### **Simple control of devices (page 199)**

Allows you to perform off/on controls for the power, shutter function, and AV muting function on registered devices.

#### **■ Editing function (on the client terminal)**

##### **Maintenance cycle editing function (page 216)**

Allows you to configure the length of time after which consumable parts replacement, parts cleaning, and regular parts replacement should be performed (maintenance cycles) for registered devices.

## What You can do with this Software

---

### ■ Early warning function settings (on the monitoring and control terminal)

#### **SNMP trap transmissions (page 236)**

Informs the SNMP manager (network device management software) of errors, warnings and notifications by sending an SNMP trap (when they occur or are cleared).

#### **Mail send function (page 239)**

Sends information on errors, warnings and notifications to a preset mail address.

#### **Detect presence of output image (page 202)**

You can detect the presence of an output image from a device based on the image from the network camera assigned to that device, and issue a notification if image output has stopped.

#### **Modify notification settings (page 245)**

Use the following steps to set the number of days remaining until a consumable parts replacement, regular periodic cleaning and non-consumable parts replacement are announced and to make settings to send notifications via mail or SNMP transmission.

#### **Set a warning to report that a device is not connected (page 243)**

Set the conditions for issuing a warning to report that a device is not connected, or specify time periods during which disconnection warnings will not be output.

#### **User account (page 247)**

You can specify the use authority of users that access a monitoring and control terminal from a client terminal.

# Preparation

## System Requirements

### ■ Software Operating Environment

The computer that will be used as a monitoring and control terminal and where the software will be installed must meet the following requirements.

<b>OS (Operating system)</b>	<b>Windows 11:</b> Windows 11 Pro (64 bit) <b>Windows 10:</b> Windows 10 Pro (32 bit/64 bit) <b>Windows Server 2016:</b> Standard (32 bit/64 bit) <ul style="list-style-type: none"><li>• The software works in 32-bit mode on 64-bit Windows.</li><li>• Compatible with English, Japanese or Chinese language versions of the above operating systems.</li><li>• Microsoft Internet Information Services (IIS) is automatically enabled when the software is installed.</li></ul>
<b>Software library</b>	Microsoft .NET Framework 4.7 <ul style="list-style-type: none"><li>• Enable the installed .NET Framework 4.7 function. (page 21)</li></ul>
<b>Web browser</b>	Microsoft Edge <ul style="list-style-type: none"><li>• The software should operate in most web browsers, excluding those above, but correct operation is not guaranteed.</li></ul>
<b>CPU</b>	Intel® Core™ 2 Duo or better, or equivalent processor <ul style="list-style-type: none"><li>• Intel® Core™ i5 or higher processors are recommended when the number of connected devices is 65 or more.</li><li>• When using the [Detect presence of output image] function, processors equipped with the integrated graphics function, which is supported by 6th generation Intel Core i7/i5 or higher processors, are recommended.</li></ul>
<b>Memory</b>	8,192 MB or higher
<b>Hard disk free space</b>	100 GB or more <ul style="list-style-type: none"><li>• Required capacity increases with increasing number of units. (Roughly 50 MB per unit.)</li></ul>
<b>Other details</b>	LAN connector (10Base-T/100Base-TX) A display with a resolution of 1,366 × 768, High Color (16-bit) or better

**Note that this does not guarantee that any computer satisfying the above requirements will be able to run the software.**

### Notes

- When using the Windows Server 2016 terminal, operating it as a server is recommended. When using it as a client, change security settings of the browser.

## System Requirements

### ■ System Requirements for Client Terminal

A web browser is used to log on to the monitoring and control terminal and view the monitoring screen.

With a LAN function and any of the web browsers listed below, a tablet can also be used for access.

<b>Windows</b>	Use any of the following web browsers. Web browser: Microsoft Edge <ul style="list-style-type: none"> <li>• The software should operate in most web browsers, excluding those above, but correct operation is not guaranteed.</li> <li>• Installation of a display plug-in or DirectX may be required depending on the camera. The web screen display function cannot be used in Microsoft Edge. (As of May 2024)</li> </ul>
<b>iOS</b>	iPhone: iOS 10, 11, 12, 13, 14 iPad: iOS 10, 11, 12 / iPadOS 13, 14 Web browser: Safari 10, 11, 12, 13, 14 <ul style="list-style-type: none"> <li>• Operation is not supported when displaying the desktop version of the site.</li> <li>• Operation is not supported when using Split View of the Multitasking function.</li> <li>• Operation of the web screen display function available on network cameras is not guaranteed. (This is due to the browser being unsupported by the camera.)</li> <li>• When displaying the &lt;Web Control&gt; window of devices on an iPhone, it will be displayed in the same screen instead of in a new tab.</li> </ul>
<b>Android</b>	Tablet running Android 7.0, 8.0, 9.0, 10.0, 11.0 Web browser: Google Chrome

**Note that this does not guarantee that any computer satisfying the above requirements will be able to run the software.**

#### Notes

- A separate wireless access point is required to access the monitoring and control terminal from a client terminal via a wireless LAN.



## Network Configuration

The following sections describe how to connect a monitoring and control terminal, client terminals\*, and devices and their peripheral devices via a network connection.

\*The client terminal needs to be connected when using the early warning function.

### ■ Necessary Environment for Computers to be Connected

Confirm that the following LAN configuration is in place before connecting the computer to the intranet.

#### Computer with a built-in LAN function

- Is your LAN switched on?

#### Computer without a built-in LAN function

- Is your LAN adapter properly recognized?
- Is your LAN adapter switched on?
- Install the required driver for the LAN adapter before making a connection. Install the driver according to the instructions in the operating instructions supplied with the LAN adapter.

#### Notes

- The monitoring and control terminal should be set to a unique, fixed address on the network, without obtaining an IP address automatically from a DHCP server.
- Installation of security features such as firewalls or LAN adapter utilities may prevent the software from establishing a connection to an intranet. Consult the administrative user if a connection cannot be established.
- There is no guarantee that the software will work with any LAN adapter or any computer with a built-in LAN adapter.

### ■ Setting the Computer

Please use a crossing cable to connect the computer and device when it is directly connected to the LAN outside the intranet.

Use a straight cable for the connection when a hub or other device is used to connect the computer and device.

#### Network Setup

- Set the IP ADDRESS, SUBNET MASK and DEFAULT GATEWAY according to the operating environment. (Please consult your network administrator for details.)
- If “Use automatic configuration script” is checked in your web browser, uncheck it.
- If “Use a proxy server for your LAN” is checked in your web browser, uncheck it or specify the device IP address in “Exceptions” in the advanced proxy settings.

#### Notes

- Depending on the system configuration, whether it is straight, cross, or both to be used, will differ. Please consult your network administrator for details.

## Network Configuration

### ■ Setting the Device

#### Network Setup

Set the HOST NAME (DEVICE NAME), IP ADDRESS, SUBNET MASK, and DEFAULT GATEWAY according to the operating environment. (Please check with your network administrator for details.)

Set DHCP to OFF and set a fixed IP address, making sure that the entered IP address is not used by any other device on the LAN.

If the entered IP address is used by another device, the device cannot be registered.

- For models that can be set, enable WEB control, PLink Control, Network Control, and Network Standby.
- For devices that need to set an administrator account, perform the settings of the administrator account.
- For models in which the Web port number can be set, set the port number to “80”.
- For models in which command control can be set, set the port number to the same number. (Default setting value: 1024)

#### Flat-Panel Display Settings

When registering a flat-panel display that belongs to the Rich information model group to the software, various settings on the display itself must be configured.

When registering a flat-panel display that belongs to the Basic information model group to the software, settings configuration on the display itself is not required.

To see which group the device to be registered belongs to, see page 25.

- Change the [Options] menu of the flat panel display unit as follows.

[LAN Control Protocol]	Set to [Protocol 2].
[RS-232C/LAN Information Timing] or [Information timing]	Set the conditions for the detection of warnings and errors.

#### Notes

- For how to set a device or peripheral device, check the operation manual of the device or peripheral device you are using.
- This software identifies the device using the configured IP address. If DHCP is set to ON in the device network setting in a network environment that uses a DHCP server etc. the DHCP server may change the IP address allocated to the device, making it impossible to connect using this software. Please ensure that the server does not change the IP address by, for example, setting the DHCP server so as to fix the IP address allocated to the device. (Consult your network administrator for details.)
- If a flat-panel display registered as a Rich information model automatically switches to the standby state during monitoring due to activation of the “No activity power off” function or other reasons, a warning is issued. To prevent warnings from being issued, it is necessary to change the configuration of the display so that it does not switch automatically to a standby state.  
If a flat-panel display registered as a Basic information model automatically switches to the standby state, a warning will not be issued.
- Configure the current time and on-screen menu language settings on a flat-panel display registered as a Rich information model if the settings are available.  
A warning may be issued if the display is used without configuring these items. If a flat-panel display is registered as a Basic information model, a warning will not occur even if you do not set the current time or select an on-screen menu language.

# Steps to Start Operation

The steps from software installation to start of operation are listed below.

## Installing the software

- 1 Downloading the installation file (page 20)
- 2 Installing the software (page 20)

The diagram illustrates the installation process. On the left, a laptop is labeled 'Computer with Internet connection'. A blue arrow points from the laptop to a document icon labeled 'Setup.msi'. A larger blue arrow points from the 'Setup.msi' icon to a desktop computer labeled 'Monitoring and control terminal'.

## Adding the licensed function

- 3 Setting the administrator password (page 26)
- 4 Input the key code to export the volume serial number (page 28)
- 5 Obtaining an activation code (page 30)
- 6 Activating the license (page 31)

The diagram illustrates the license activation process. On the left, a laptop is labeled 'Computer with Internet connection' and is connected to a globe icon. A dashed green arrow labeled 'Key code' points from the laptop to a terminal window. The terminal window shows an 'Administrator' password prompt and a 'Key code' input field. Below the terminal, a document icon labeled 'SERIAL.LST' is shown. A dashed green arrow labeled 'ACTIVE.LST' points from the terminal to another document icon labeled 'ACTIVE.LST'. A large green arrow points downwards from the terminal area, indicating the flow of the process.

## Installing the Software on the Monitoring and Control Terminal

If you are using a previous version of the “Multi Monitoring & Control Software” or “Early Warning Software”, you can continue using your existing data as-is by following the installation procedure below.

### Downloading the installation file

**1 You can download the installation file from the following websites.**

<https://panasonic.net/cns/projector/download/application/>  
<https://panasonic.net/cns/prodisplays/download/software/>

**2 The terms for the application software download will appear. After reading them, click [Agree].**

File name: MMCS\_V3xxx\_Setup.zip (where “3xxx” is the software version).

### Notes

- If the version of the software is not compatible with your devices, some device information may not be displayed. Please download the latest software.

### Installing the software

Install the software on the monitoring and control terminal.

#### Preparation:

- Make sure the Windows Update program is up to date.
- Verify that .NET Framework 4.7 is installed on your computer and that the .NET Framework 4.7 function is enabled.
- Close all programs that are running on Windows.

**1 Extract the file “MMCS\_V3xxx\_Setup.zip” after it has finished downloading.**

**2 Double click “Setup.msi” in the folder created during extraction.**

The installer will start.

Verify that the [Publisher] field displayed during installation is set to Panasonic Connect Co., Ltd. before continuing the installation.

**3 Follow the instructions on the screen to complete the installation.**

When the installation completes, the completion screen appears.

**4 Click [Close].**

The shortcut icon  will appear on the desktop.

## Installing the Software on the Monitoring and Control Terminal

---

### ■ The following message will appear during installation

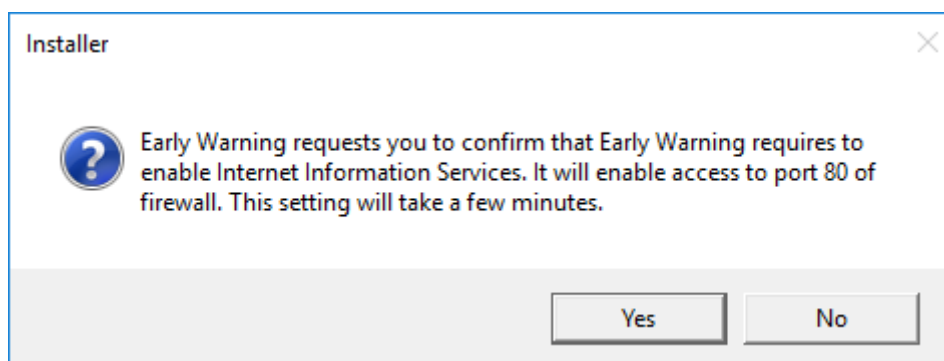

**[Yes]:** Continue installation.

**[No]:** Abort the installation.

- For details about your computer settings and network environment, consult your network administrator.

#### Notes

- The installation may terminate unsuccessfully if you attempt to install the software while Windows Update is running or if the PC is in a state that requires it to be restarted.
- When using the software for the first time on a computer, always run Windows Update to install any required updates before using the software. The software may not operate if you attempt to use the software without running Windows Update.
- If .NET Framework 4.7 is not installed or the function is not enabled, an error will occur during installation of the software. In such cases, click [No] to cancel installation of the software, and enable the .NET Framework 4.7 function before performing installation again. See “Cannot install the software” in the “Frequently Asked Questions” section. (page 261)
- The update installer may take some time if there are many registered devices when performing the update installing. For example, if there are more than 513 devices registered, installation may take about ten minutes on a computer with 4 GB of memory.

## Installing the Software on the Monitoring and Control Terminal

### Repairing or removing the software

If you run the installer again on the monitor and control terminal when this software has already been installed, a screen asking if you want to repair or remove the software appears.

- 1 In step 3 of “Installing the software” (page 20), select whether you want to “Repair” or “Remove” the software, and then click [Finish].**

**Repair:** Repair defects in the software

**Remove:** Uninstall the software and reinstall it

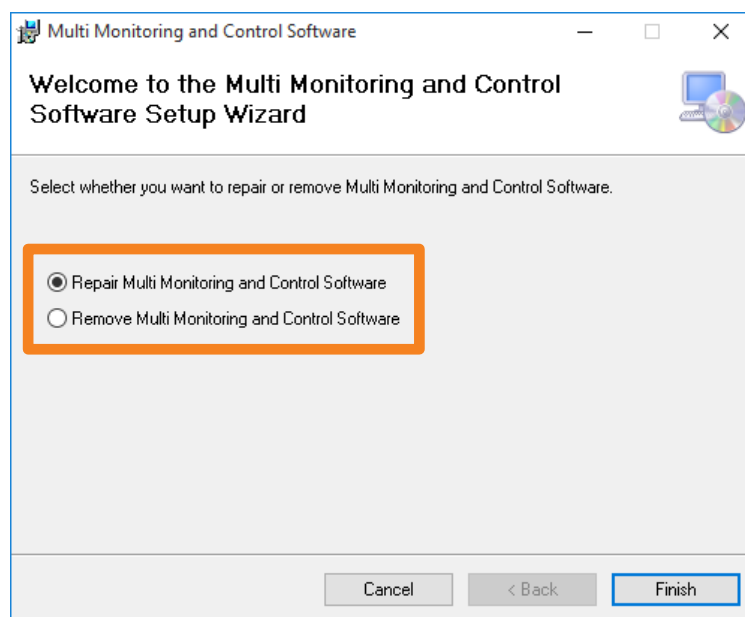

(When “Repair” is selected)

- 2 Follow the instructions on the screen to continue the installation.**

When the installation completes, the completion screen appears.

- 3 Click [Close].**

## Installing the Software on the Monitoring and Control Terminal

## Starting the software

1 Double-click  on the desktop to start it.

You can also start the software by selecting [Start] → [Panasonic] → [Multi Monitoring & Control Software].

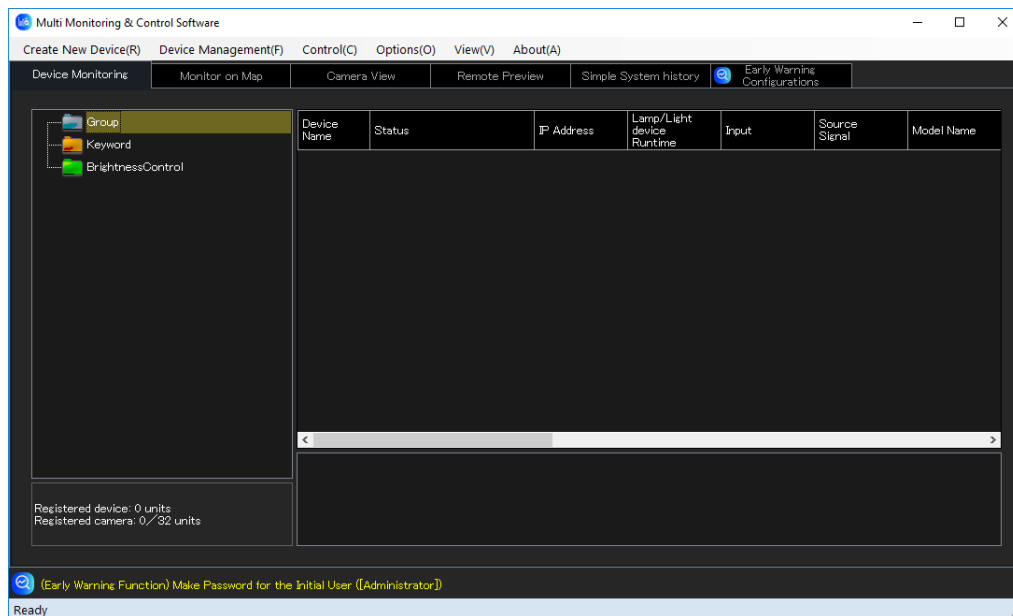

## Confirming the software version

1 Select [About] → [Version] from the menu.

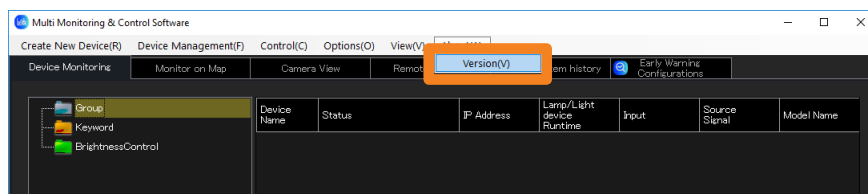

2 After checking the version, click [Close] to close the screen.

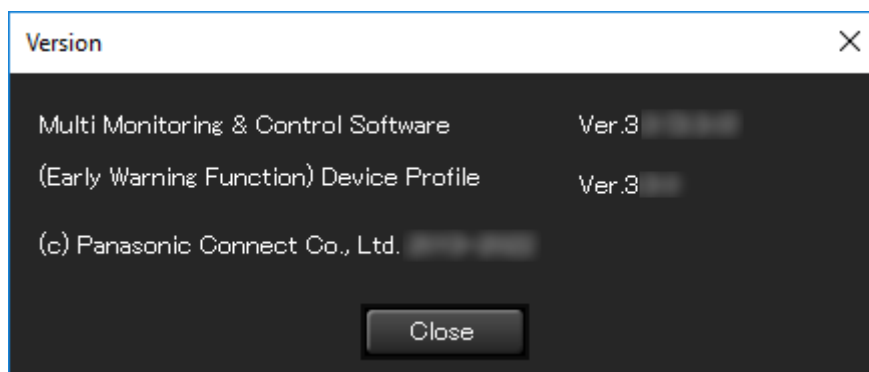

## Installing the Software on the Monitoring and Control Terminal

## Exiting the software

1 Click  on the screen.

- You can also exit by choosing [Device Management] → [Exit] from the menu.

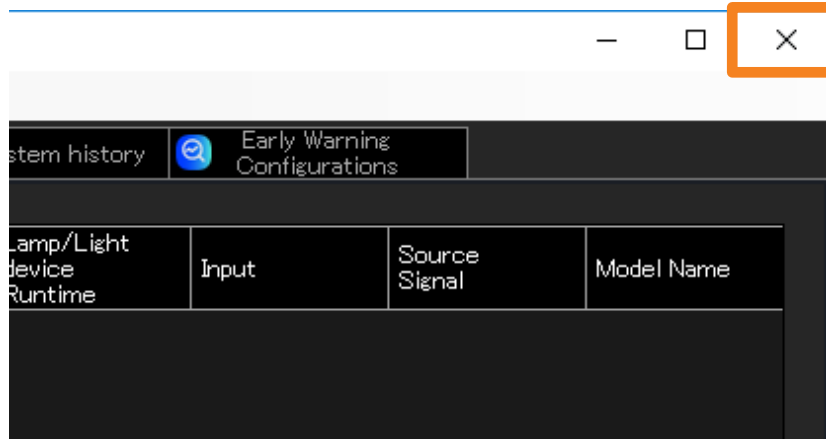



## Before Using this Software

### Checking whether devices are supported

For the devices and peripheral devices compatible with this software, please visit the following websites.

<https://panasonic.net/cns/projector/download/application/>

<https://panasonic.net/cns/prodisplays/download/software/>

Devices are categorized into one of two groups depending on the type of information that can be accessed from them by the software. The difference in the type of information that can be accessed for “Rich information model” and “Basic information model” is as follows. For more information about each model, see page 184.

○: Accessible  
–: Not accessible

Item name	Group designation based on accessible information	
	Rich information model	Basic information model
<b>Common items</b>		
Group Name	○	○
IP Address	○	○
Shutter (AV Mute)	○	○
Model Name	○	○
Serial Number	○	–
Selected input	○	○
Power	○	○
Power on count	○	–
Source Name	○	–
Signal Freq.	○	–
Main/Sub Version	○	–
Network Version	○	–
AC Voltage	○	–
Power on hours	○	○
Temperature	○	–
Fan status	○	–
<b>Projector only</b>		
Selected LIGHT	○	–
LIGHT Power / Operating Mode	○	–
LIGHT status	○	○
<b>Flat-panel display only</b>		
Power consumption reduction setting	○	–

#### Notes

- The Device Profile Library is updated from time to time. Before registering a new device, be sure to update the Device Profile Library. (page 33)
- May not be accessible depending on the device even if it is described as accessible in the table.

## Setting early warning function

### Setting the administrator password

- 1 Click [Early Warning Configurations] tab → [Administrator Password] tab.

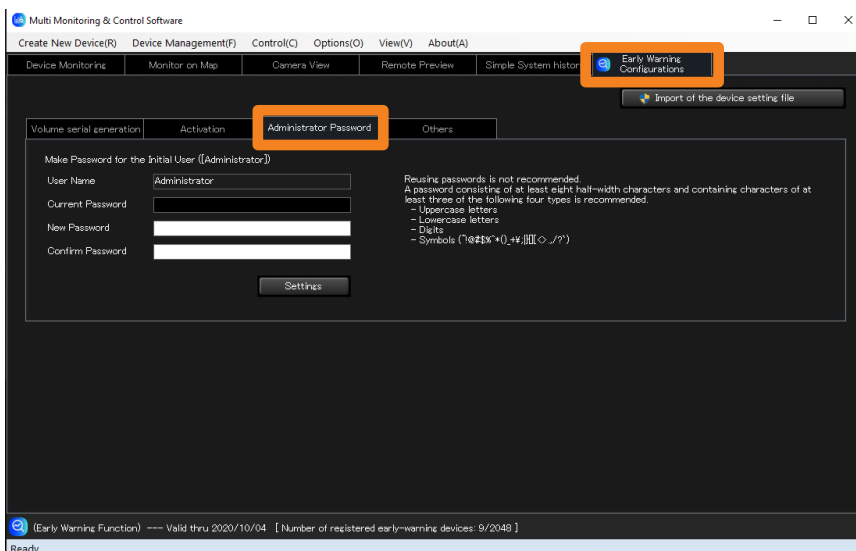

- 2 Enter [New Password].

A total of 64 single-byte alphanumeric characters and symbols can be registered as a password.

- [Administrator] is the only valid administrator user name.

- 3 In the [Confirm Password] field, enter the same character string in step 2 and then click [Settings].

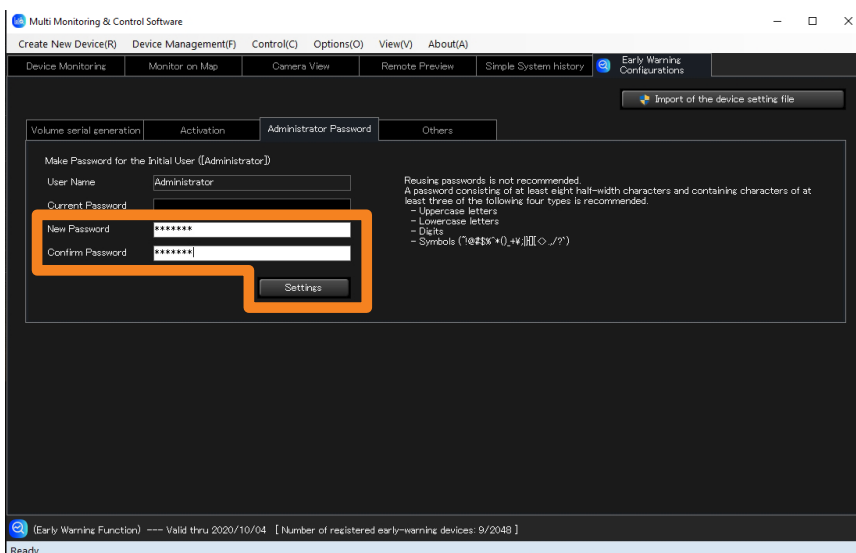

## Setting early warning function

---

### 4 When the success message is displayed, click [OK].

The new password is now set, and the expiration date is displayed in the status bar at the bottom of the screen.

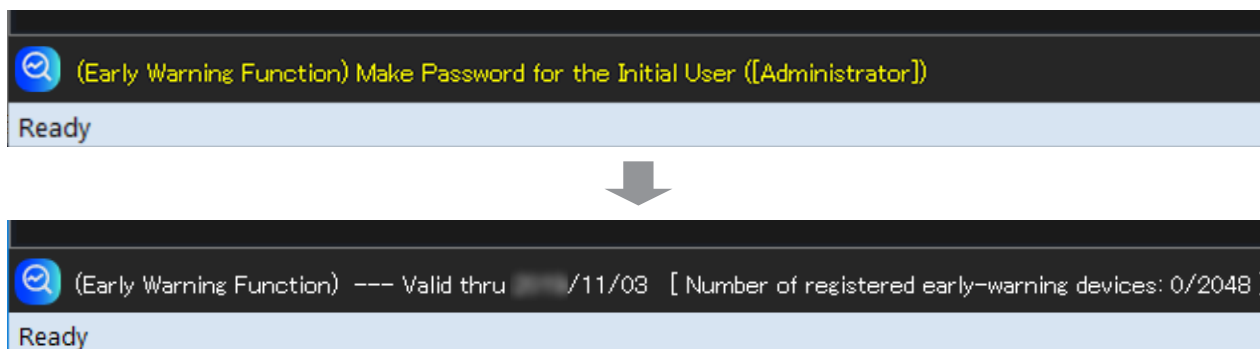

### Notes

- When changing the administrator password, authentication of the currently set password is required.
- When the currently set password is forgotten, reinstalling the application is required.

## Setting early warning function

### Activating

If a license has already been purchased, perform activation with the following steps.

#### Prepare the key code of the purchased license

Make sure you have the label containing the key code for the purchased license available before activating the software using the following procedure.

#### Exporting the volume serial number

Enter the key code listed on the key code label to export the volume serial number.

**1** Click [Early Warning Configurations] tab → [Volume serial generation] tab.

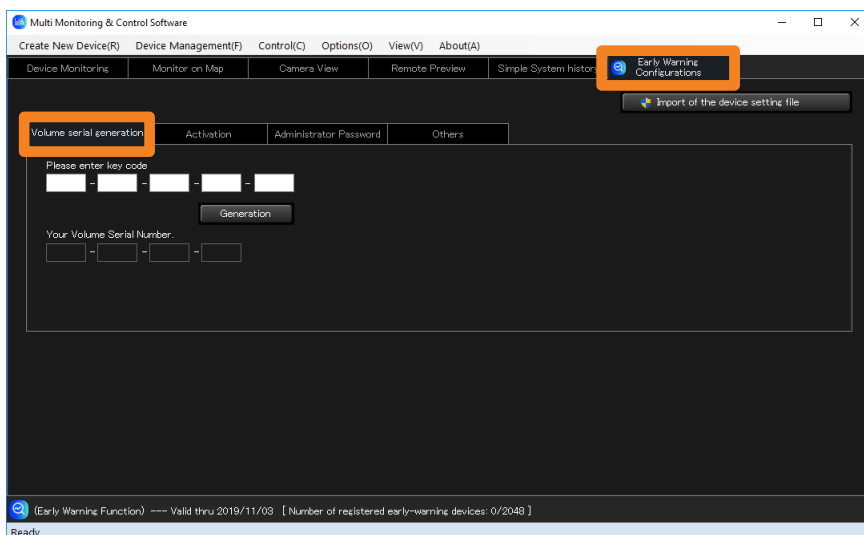

## Setting early warning function

### 2 Enter the key code on the key code label and click [Generation].

The key code is a 25-character, single-byte alphanumeric string. Enter 5 characters in each field.

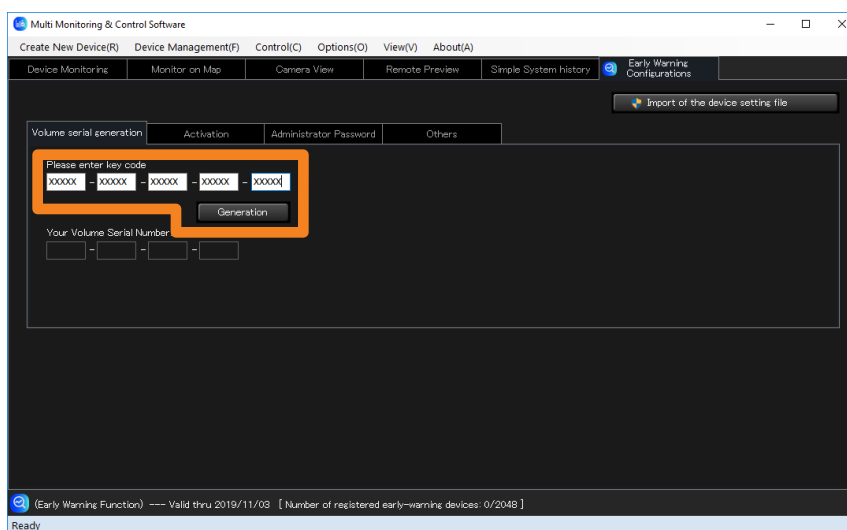

### 3 Specify a location to save the file to and click [Save].

File name: SERIAL.LST

- The file name can be changed, but not the extension (.LST). (This document assumes the file is named SERIAL.LST.)

### 4 Once the file is saved, [Your Volume Serial Number.] is displayed for manual entry. Proceed to the next step.

- There are two ways to use the exported volume serial number. One is to use the saved SERIAL.LST file. The other is to directly enter the number displayed under [Your Volume Serial Number.].

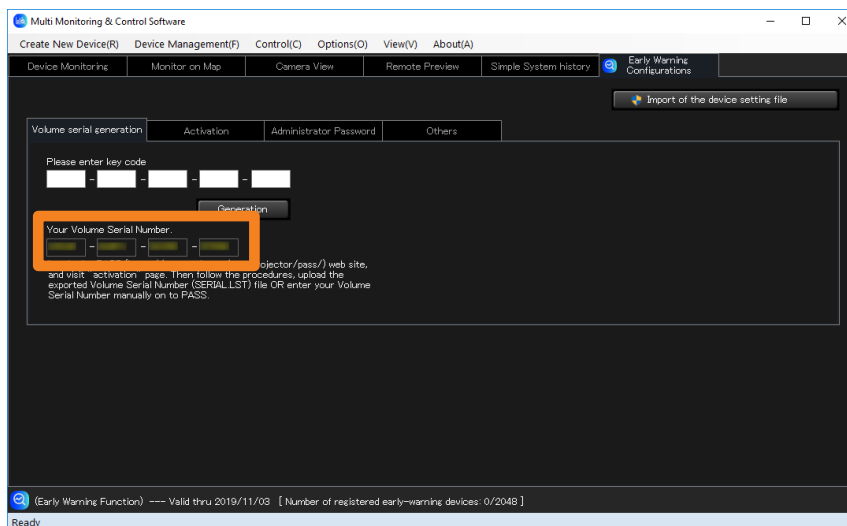

## Notes

- If you export the volume serial number again without completing activation, the activation code acquired using the previous volume serial number is disabled and can no longer be used. When performing activation, always use the activation code acquired using the most recent volume serial number.

## Setting early warning function

## Obtaining an activation code

Use the exported volume serial number to log in to PASS and obtain an activation code.

**1 Log in to [PASS] from one of the following websites.**

<https://panasonic.net/cns/projector/pass/>  
<https://panasonic.net/cns/prodisplays/pass/>

- If you are not a registered member of PASS, you will need to register as a new member (free of charge).

**2 Click [Activation] from the side menu.**

The website for issuing the activation code appears.

**3 Select [Early Warning Software], and when the [Notes on Activation of Early Warning Software] appears, read it and then click [Confirm].**

**4 After reading the on-screen instructions, select the method for registering the volume serial number.**

[File upload →]: Upload the SERIAL.LST file

[Manual entry →]: Manually enter the volume serial number

**5 (When [File upload →] is selected)**

**Follow the on-screen instructions to upload the volume serial number file (SERIAL.LST).**

(When [Manual entry →] is selected)

① **Follow the on-screen instructions and select [License Model Number].**

② **Enter the character string displayed in [Your Volume Serial Number.] into the [Volume Serial Number], and click [Register].**

**6 When the key code input screen is displayed, enter the key code displayed on your key code label, and click [Next].**

The key code is a 25-character alphanumeric string. Enter 5 characters in each box.

**7 When the “Your code is ready to be issued” screen is displayed, click [Save].**

When issuing is completed, the activation code for manual entry will be displayed.

- Make a note of the activation code (30-character alphanumeric string) that is displayed to use when carrying out activation by manual input.

## Setting early warning function

## Activating the software

Use the activation code to carry out the activation in the software.

**1** Click [Early Warning Configurations] tab → [Activation] tab.

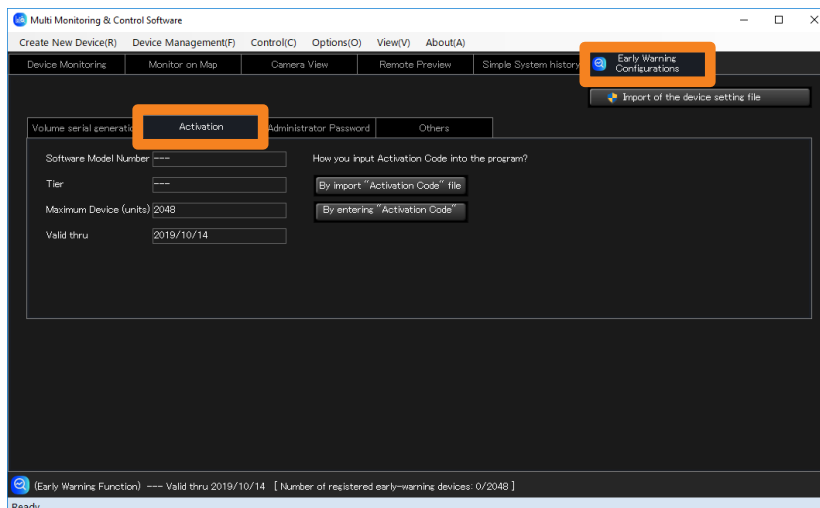

**2** Click on an activation method to select it.

**[By import "Activation Code" file]:** Import the ACTIVE.LST file (Go to step **3** in page 32)

**[By entering "Activation Code"]:** Manually enter activation code (Go to step **5** in page 32)

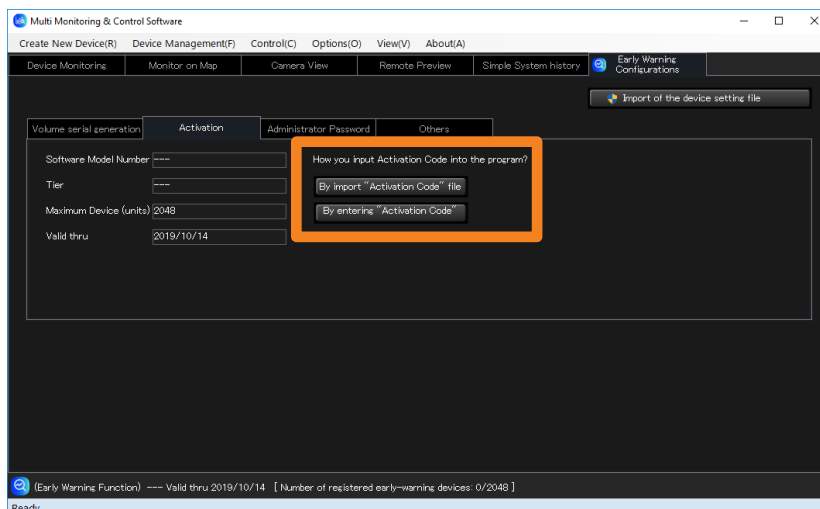

## Setting early warning function

---

(When [By import “Activation Code” file] is selected)

**3** Select the “ACTIVE.LST” file that you saved in step 7 of “Obtaining an activation code” (page 30).

**4** Click [Open] to start activation.

When activation is completed, a confirmation message will appear, displaying the [Software Model Number], [Tier], [Maximum Device (units)], and [Valid thru].

(When [By entering “Activation Code”] is selected)

**5** Enter the activation code from step 7 of “Obtaining an activation code” (page 30).

The activation code is a 30-character alphanumeric string.

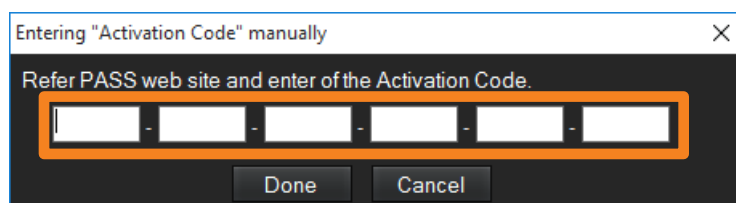

**6** Click [Done] to start activation.

When activation is completed, a confirmation message will appear, displaying the [Software Model Number], [Tier], [Maximum Device (units)], and [Valid thru].

### Notes

- When activation is completed, the valid thru date in the status bar at the bottom of the screen changes to the expiration date of the purchased license.
- Activation cannot be performed in the following cases.
  - The key code has already been used for a previous activation.
  - The key code entered when exporting the volume serial number is different from the key code entered when registering the volume serial number on PASS.
- The license expiration date of this software is calculated starting from the date of completion of activation.



## Setting early warning function

---

### Updating the device profile library

---

If there is additional information for each device during this software is being used, you can display the additional information by updating the Device profile library even with this software.

#### Downloading the device profile library

**1 Log in to [PASS] from one of the following websites.**

<https://panasonic.net/cns/projector/pass/>  
<https://panasonic.net/cns/prodisplays/pass/>

- If you are not a registered member of PASS, you will need to register as a new member (free of charge).

**2 Click [Download] from the side menu.**

The download page will appear.

**3 Select [Utility Software] → [Multi Monitoring and Control Software] → [Device Profile Library] → [Setting file].**

**4 Select [Early Warning Function | Device Profile Library] → [Latest Version] → [Download].**

Name of compressed file: DeviceProfileLibrary\_VerX.X.XX.zip (where “XX” is the version)

**5 Extract the compressed file that was downloaded in step 4.**

Name of file: DeviceProfileLibrary\_VerX.X.XX.UPD (where “XX” is the version)

#### Notes

- Since this operation is only performed when additional information is released for each device that is supported by this software, this operation is normally not necessary. When additional information is released, operations after step **3** become possible.
- To update the Device Profile Library, the software must be updated to a version that supports the Device Profile Library update file.
- When registering a new device that belongs to the “Basic information model” group, Device Profile Library update is not required.

## Setting early warning function

### Updating the device profile library

- 1 Start the software. (page 23)
- 2 Open the [Early Warning Configurations] tab and click [Import of the device setting file].

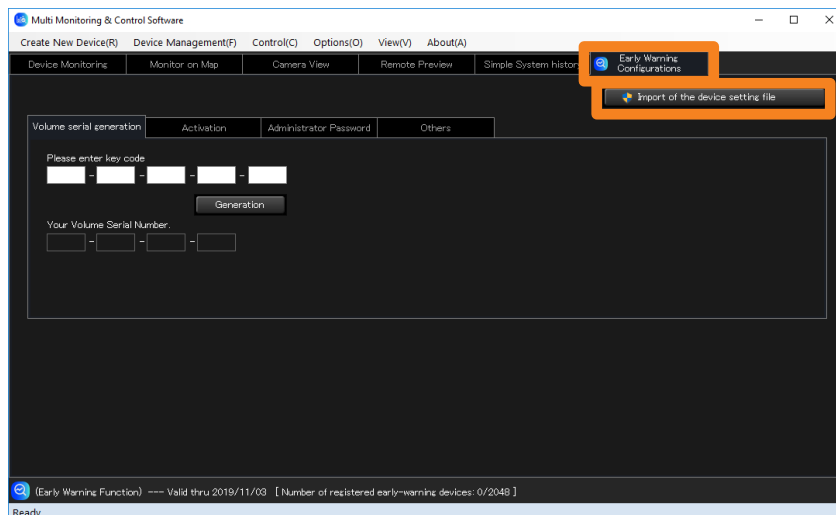

- 3 Click [Yes] in the user account control screen that appears.
- 4 Select the Device Profile Library that was saved in “Downloading the device profile library” (page 33).  
The update will begin.
- 5 When the success message is displayed, click [OK].
  - Verify the version of the Device Profile Library on the [Version] screen. (page 23)

### Notes

- It is not possible to return a Device Profile Library to an earlier version.
- When registering devices, the software categorizes models into groups based on the Device Profile Library. For devices categorized as “Rich information model”, if no Device Profile Library corresponding to the device is imported, it is registered as a “Basic information model” device. The device will be recognized as a “Rich information model” device once you update the Device Profile Library for that device.  
The Device Profile Library is updated from time to time. Before registering a new device, be sure to update the Device Profile Library. (page 34)
- If devices that are categorized as “Basic information model” during registration are changed to “Rich information model” due to updating the device setting file, the settings related to the maintenance of that device will return to the state when it was bought. Redo the setting related to the maintenance of the device.
- For details about model groups, see page 25.

## Setting early warning function

## Logging in from a web browser

By logging in to the early warning function using a web browser, you can monitor the status of devices from a remote location inside the intranet.

### 1 Start the web browser and enter the following URL.

`http://xxx.xxx.xxx.xxx/ews`

Where “xxx.xxx.xxx.xxx” is the IP address of your monitoring and control terminal.

### 2 When the login screen appears, enter the [User Name] and [Password].

- For details on registering or changing user information, see page 247.

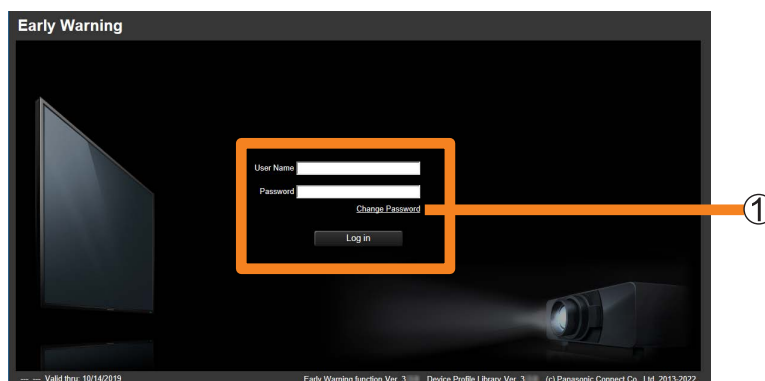

### Changing the password

You can change the password of the user registered at [User account] (page 247).

### 1 In the screen of step 2 above, input the [User Name] and [Password] of the user whose password you want to change, and click [Change Password] (①).

- Change the Administrator password from the software. (page 26)

### 2 Enter user name and password then click [Change Password].

- If there is a mistake in the entry, an error message will be displayed.

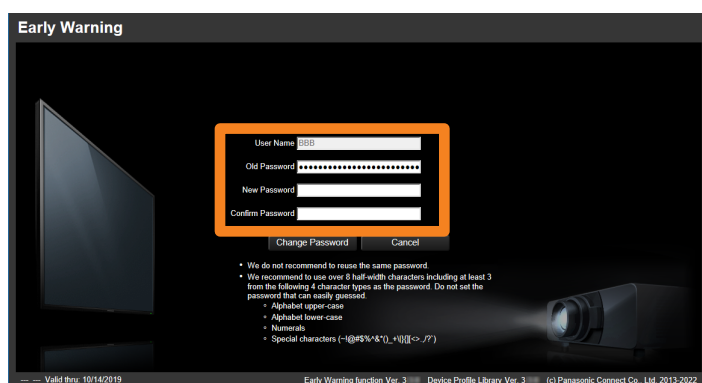



## Exiting

### 1 Close the web browser.

## Uninstalling the software

### 1 Follow these steps to open the [Apps & features] window.

- ① Click  → [ Settings].
- ② Select [Apps] on Windows Settings.
- ③ Select [Multi Monitoring and Control Software], and click [Uninstall].

### 2 When the confirmation message appears, select [Yes] or [No].

**[Yes]:** Delete the registered device data and uninstall the software.

**[No]:** Uninstall the software but preserve the registered device data.

- If you select [No], you can continue to use the preserved data after installing this software again or after upgrading the software.

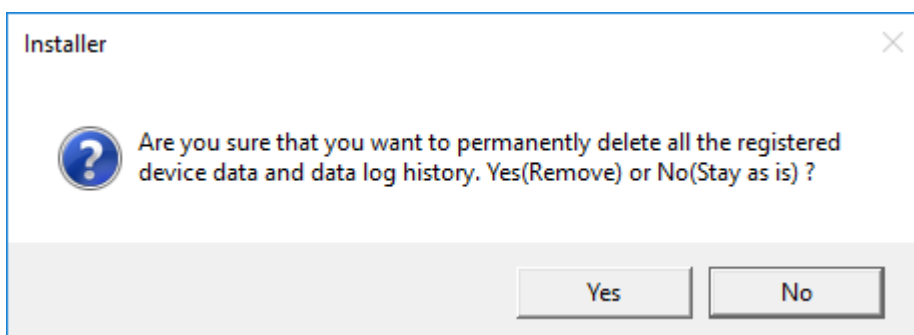

# Registering a Device to Monitor and Control



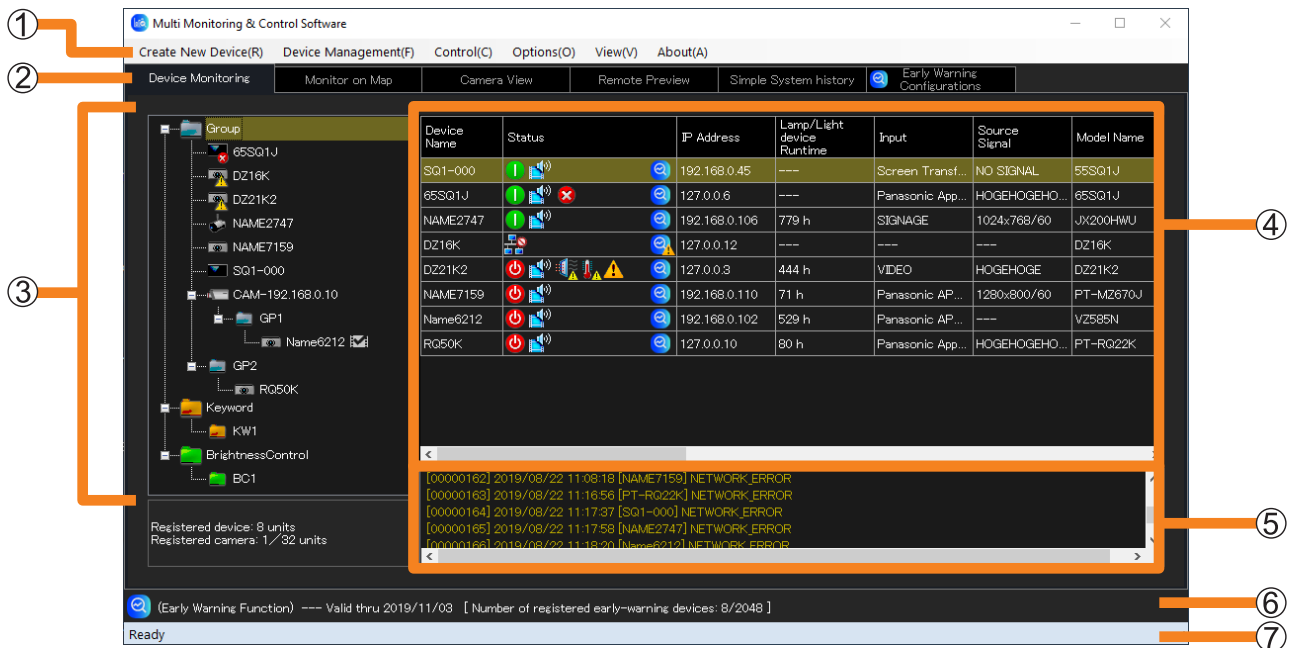







## About the <Device Monitoring> Window





<Device Monitoring> window

<p>① Menu</p>	<p>Functions are arranged as individual menu items.          [Create New Device] (page 39)          [Device Management]: Device management menu excluding the registration of devices and peripheral devices.          [Control] (page 112)          [Options] (page 124, 228)          [View] (page 38)          [About] (page 23)</p>
<p>② Screen switching tabs</p>	<p>[Device Monitoring] (page 77)          [Monitor on Map] (page 72)          [Camera View] (page 92)          [Remote Preview] (page 94)          [Simple System history] (page 96)          [Early Warning Configurations] (page 235)</p>

## About the <Device Monitoring> Window

<p>③ <b>Tree pane</b></p>	<p> <b>[Group]:</b> A parent group ([Group] folder) This is the folder that the tree is composed from.</p> <p> : Group folder (page 60)</p> <p> : Network camera (page 54)</p> <p> : Projector (Rich information model)</p> <p> : Flat panel display (Rich information model)</p> <p> : Illumination-type projector (Rich information model)</p> <p> : Basic information model device</p> <p> <b>[Keyword]:</b> The keyword created will be displayed. (page 62)</p> <p> <b>[BrightnessControl]:</b> The brightness control created will be displayed. (page 65)</p> <ul style="list-style-type: none"> <li>• Register devices directly under the parent group ([Group] folder) or under a group folder or network camera. (page 39)</li> <li>• When you set video stop determination with a device linked to a network camera,  will be displayed on the right side of the device name. (page 202)</li> </ul>
<p>④ <b>Brief information display pane</b></p>	<p>Lists the status of the devices selected in the tree pane (③). (When a folder is selected, multiple lines of information are displayed.)</p> <ul style="list-style-type: none"> <li>• When “▲” is displayed when an item of the list is selected, you can display it by descending order or ascending order.</li> </ul>
<p>⑤ <b>Command execution log pane</b></p>	<p>Displays the execution results of the control command (page 112) or scheduling function (page 122) and the connection status of the device.</p>
<p>⑥ <b>Early warning function message display area</b></p>	<p>Displays the early warning function’s activation status and messages.</p> <ul style="list-style-type: none"> <li>• You can select whether or not to display from the menu’s (①) [View] → [Early warning function message].</li> </ul>
<p>⑦ <b>Status bar</b></p>	<p>Displays the status of this software.</p> <ul style="list-style-type: none"> <li>• You can select whether or not to display from the menu’s (①) [View] → [Status Bar].</li> </ul>

### Notes

- Refer to the following about warnings or errors (Example: , ) displayed on the icon.
  - Tree pane (page 78)
  - Brief information display pane (page 79)
- For details about “Rich information model” and “Basic information model”, see page 25.

## Registering Devices and Peripheral Devices to Monitor and Control

Up to 2,048 devices can be registered. There are several registration methods to choose from depending on your environment.

<b>[Individual Registration of Device]</b>	Register devices or DIGITAL LINK Switchers manually (page 39)
<b>[Auto Search of Device]</b>	Search and register connected devices (page 43)
<b>[File(.csv) Registration of Device]</b>	Register devices by importing a file (page 46)
<b>[Geometry Manager Pro]</b>	Register devices by importing an external setup file (Geometry Manager Pro) (page 48)
<b>[Network camera registration]</b>	Register a network camera (page 54)

### Notes

- The monitoring and control terminal cannot register devices when it is communicating with a device. Register at another time.
- When registering a flat-panel display that belongs to the Rich information model group, set [LAN Control Protocol] to [Protocol 2]. (page 18)
- To register DIGITAL LINK Switchers after completing registration of a device, see page 52.
- A DIGITAL LINK Switcher cannot be registered independently without linking it to a device.
- More DIGITAL LINK Switchers than devices cannot be registered.
- The same peripheral device can also be registered to multiple devices.
- To update the Device Profile Library of a device before it is registered and categorized into a model group, see page 34. (Early warning function)
- After registering a device, if you change the [User Name] or [Password] of the administrator account or the [Password] of the PJLink of the device that is used with the WEB control function or the content manager function, the device will no longer be able to communicate and will need to be re-registered.

## Registering devices or DIGITAL LINK Switchers manually

- 1 Select **[Create New Device]** → **[Individual Registration of Device]** from the menu.

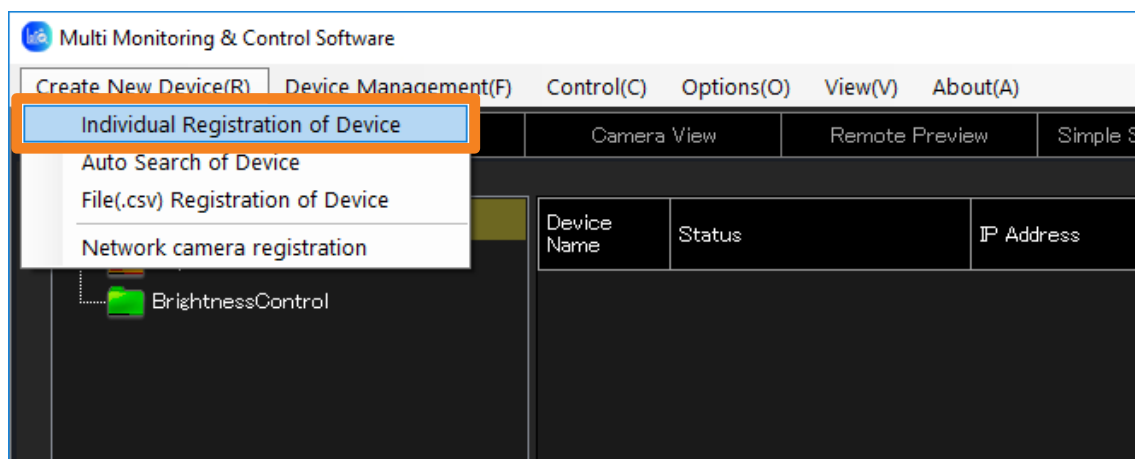

## Registering Devices and Peripheral Devices to Monitor and Control

**2** Enter the [IP Address], [User Name], and [Password] stored in the device you want to register.

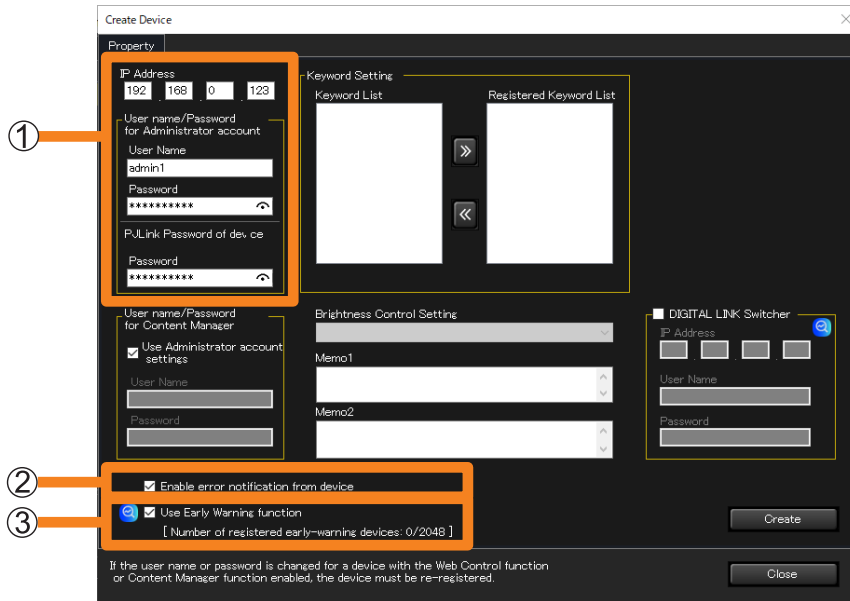

<p><b>[IP Address]</b></p>	<p>Carefully enter the IP address assigned to the device you want to register.</p> <ul style="list-style-type: none"> <li>You cannot register the same IP address to multiple devices. If you want to register an individual device using an IP address that has already been assigned, see page 68.</li> </ul>
<p><b>Administrator account</b></p>	
<p>① <b>[User Name]</b></p>	<p>Carefully enter the user name that was configured on the device you want to register.</p> <p>Basic information model: Registration is possible without entering a name.</p> <p>Rich information model: If you enter a user name that does not match the name stored on the device, registration will not be possible.</p>
<p><b>[Password]</b></p>	<p>Carefully enter the password that was configured on the device you want to register.</p>
<p><b>PJLink [Password]</b></p>	<p>Carefully enter the password that was configured on the device you want to register.</p>
<p>② <b>[Enable error notification from device]</b></p>	<p>You can select or deselect this check box to set the error notification function of the device you want to register.</p>
<p>③ <b>[Use Early Warning function]</b></p>	<p>For each registered device, you can select or deselect this check box to change the number of devices that use the early warning function.</p> <p><b>[Number of registered early-warning devices: XXXX/2048]:</b> The total number of devices with the check box selected is displayed as “XXXX” of the number of registered early-warning devices. (The number of devices that can be registered differs depending on the license.)</p>

- When you click  displayed on the right side of the password input field, it switches between displaying and hiding the input content.
- Up to 512 characters may be entered into the fields [Memo1] and [Memo2]. Enter any comment you may want to add.
- Click [Close] to stop the device registration.
- If you are registering the device only, skip ahead to step 4.



## Registering Devices and Peripheral Devices to Monitor and Control

- 3** Select the check box of ④ and enter the DIGITAL LINK Switcher's set [IP Address], [User Name], and [Password].

The screenshot shows the 'Create Device' dialog box with the following fields and options:

- Property**
  - IP Address: 192, 168, 0, 123
  - User name/Password for Administrator account:
    - User Name: admin1
    - Password: [masked]
  - P.Link Password of device:
    - Password: [masked]
- Keyword Setting**
  - Keyword List: [empty]
  - Registered Keyword List: [empty]
- User name/Password for Content Manager**
  - Use Administrator account settings
  - User Name: [empty]
  - Password: [empty]
- Brightness Control Setting**
  - Memo1: [empty]
  - Memo2: [empty]
- DIGITAL LINK Switcher**
  - DIGITAL LINK Switcher
  - IP Address: [empty]
  - User Name: [empty]
  - Password: [empty]
- Enable error notification from device
- Use Early Warning function [Number of registered early-warning devices: 0/2048]

Buttons: Create (5), Close (6)

Footer: If the user name or password is changed for a device with the Web Control function or Content Manager function enabled, the device must be re-registered.

- 4** Click [Create] (⑤).

- Devices in which an administrator account is not set, cannot be registered. Set the administrator account of the device, and then click [Create] (⑤).
- Click [Close] if you decide not to perform the registration.

- 5** When the “registration successful” message appears, click [OK].

- 6** Click [Close] (⑥).

The registered device will appear in the tree pane on the <Device Monitoring> window.

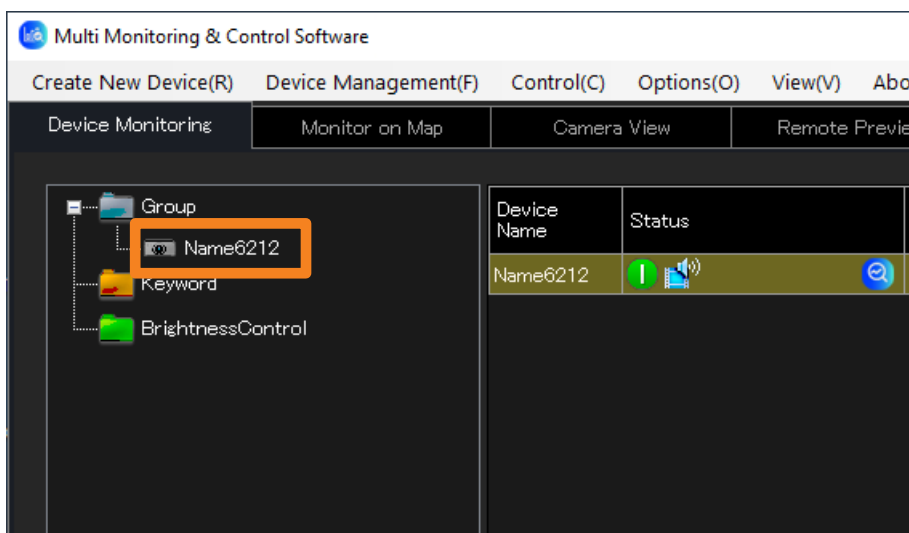

## Registering Devices and Peripheral Devices to Monitor and Control

### ■ Registering a new DIGITAL LINK Switcher to a device that has already been registered

- 1 From the tree pane on the <Device Monitoring> window, select the device to which the DIGITAL LINK Switcher is to be added then right-click it, and select [Property].

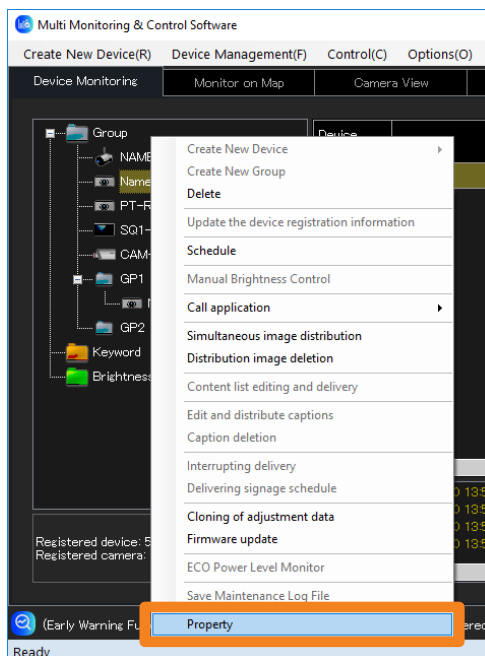

- 2 Click [Change peripheral device] (①) and register the DIGITAL LINK Switcher.

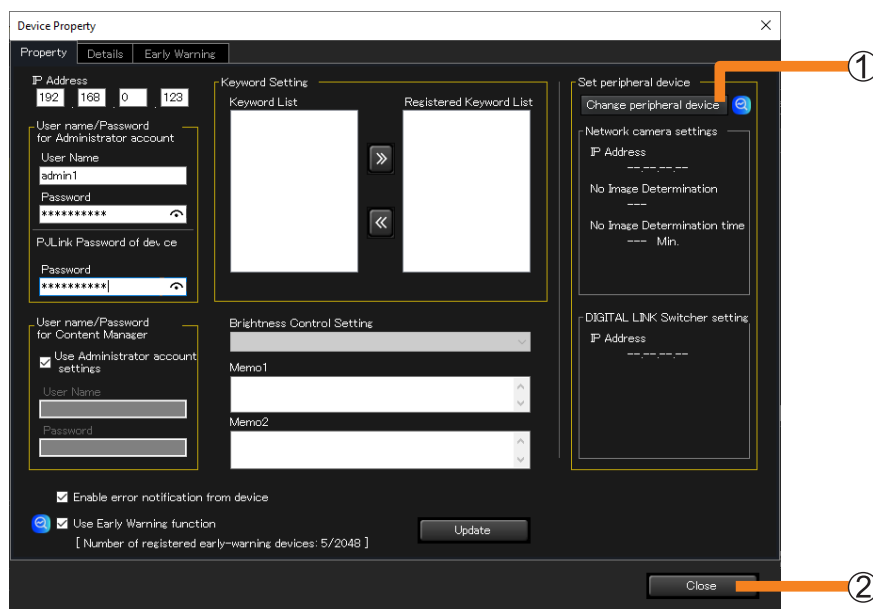

- 3 Click [Close] (②).

### Registering connected devices by Auto Search

1 Select [Create New Device] → [Auto Search of Device] from the menu.

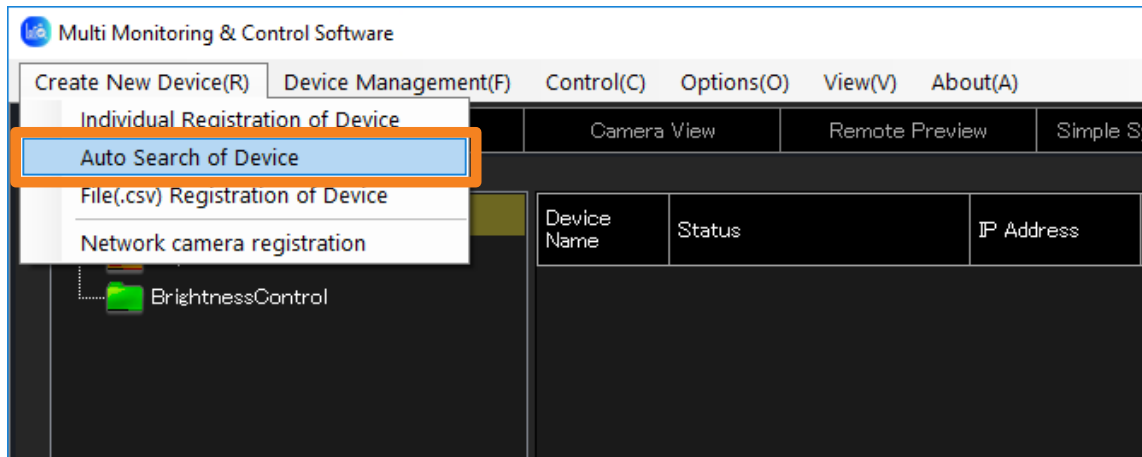

2 Enter the following items regarding the device to be registered.

- [User Name] and [Password] of the administrator account
- [Password] of the PJLink
- For more information about the [User Name] and [Password], see page 40.

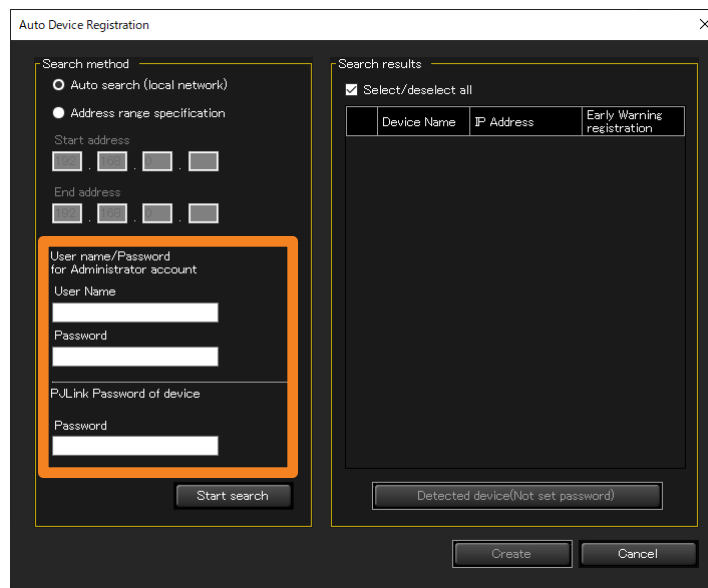

## Registering Devices and Peripheral Devices to Monitor and Control

### 3 Choose a search method (①) and click [Start search] (②).

**[Auto search (local network)]:** Find registerable devices that are connected on the same network as the monitoring and control terminal.

**[Address range specification]:** Search the specified IP address range.

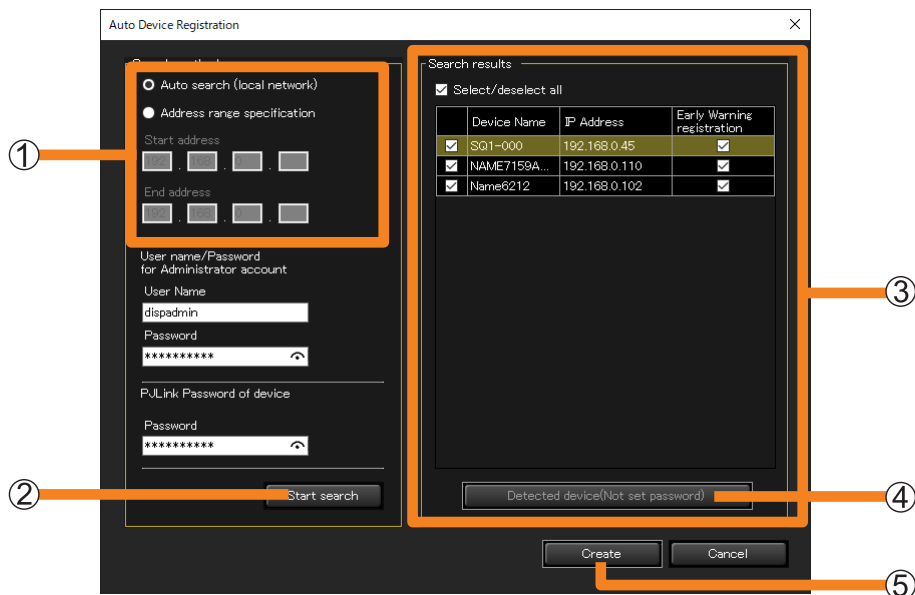

The search results are displayed in ③.

- When devices in which an administrator account is not set is detected and displayed in the search results, [Detected device(Not set password)] (④) will be enabled. When setting an administrator account, refer to page 45.

### 4 In the search results (③), select the leftmost check boxes of the devices to be registered.

- If you want to use the early warning function, also select the [Early Warning registration] check box.

### 5 Click [Create] (⑤).

The registered devices will appear in the tree pane on the <Device Monitoring> window.

## Registering Devices and Peripheral Devices to Monitor and Control

### ■ When an administrator account is not set

#### 1 Click [Detected device(Not set password)] (④) (page 44).

The detected devices will be displayed as a list

#### 2 Confirm the IP Address and click [WEB].

When the setting window of the device is displayed on the web browser, perform network settings.

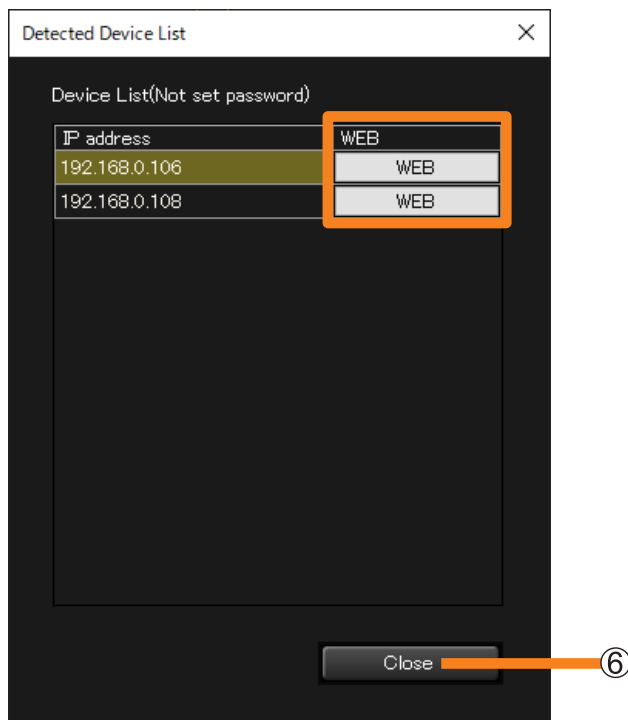

#### 3 When the network settings are completed, return to the screen of step 2, and then click [Close] (⑥).

It will return to the [Auto Device Registration] screen of step 3 on page 44.

#### 4 Click [Start search] (②) on the [Auto Device Registration] screen, and continue to perform steps 4 and 5 of page 44.

### Notes

- Searching and registering devices may take a long time.
- Depending on the state of the devices and the network environment, it may not be possible to recognize devices using the search function.
- The number of units that can be selected for early warning registration is limited by the license being used.
- Devices that can be searched for with [Auto search (local network)] are limited to those supporting the proprietary command for search. To see if a device being used supports the [Auto search (local network)] function, refer to the “List of Compatible Device Models” of this application software which is posted on the following website.  
<https://panasonic.net/cns/projector/download/application/>  
<https://panasonic.net/cns/prodisplays/download/software/>

### Registering devices by importing a file

- 1 Select [Create New Device] → [File(.csv) Registration of Device] from the menu.

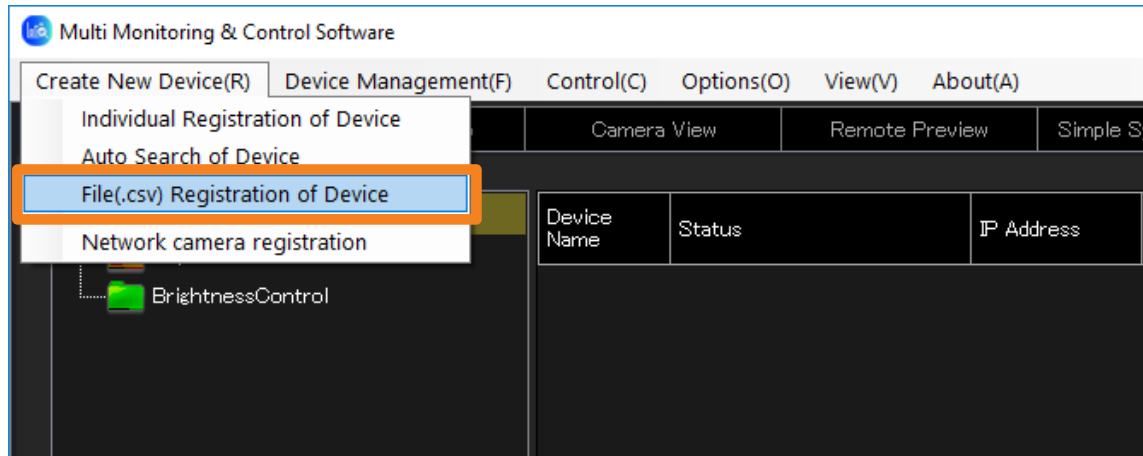

- 2 Select the CSV file that stores the information on the devices to be registered, and click [Open].

- A CSV file is a text file in which the fields are separated by commas. The CSV files used in this software are written in the format "IP address, user name, password, PJLink password", with one device represented per line.

Example:

192.168.0.8,User name1,Password1,PJLinkPassword1 [line break]

192.168.0.9,User name2,Password2,PJLinkPassword2 [line break]

⋮

## Registering Devices and Peripheral Devices to Monitor and Control

### 3 Place a check on the check box on the left side of the device you want to register.

If you want to use the early warning function, also select the [Early Warning registration] check box.

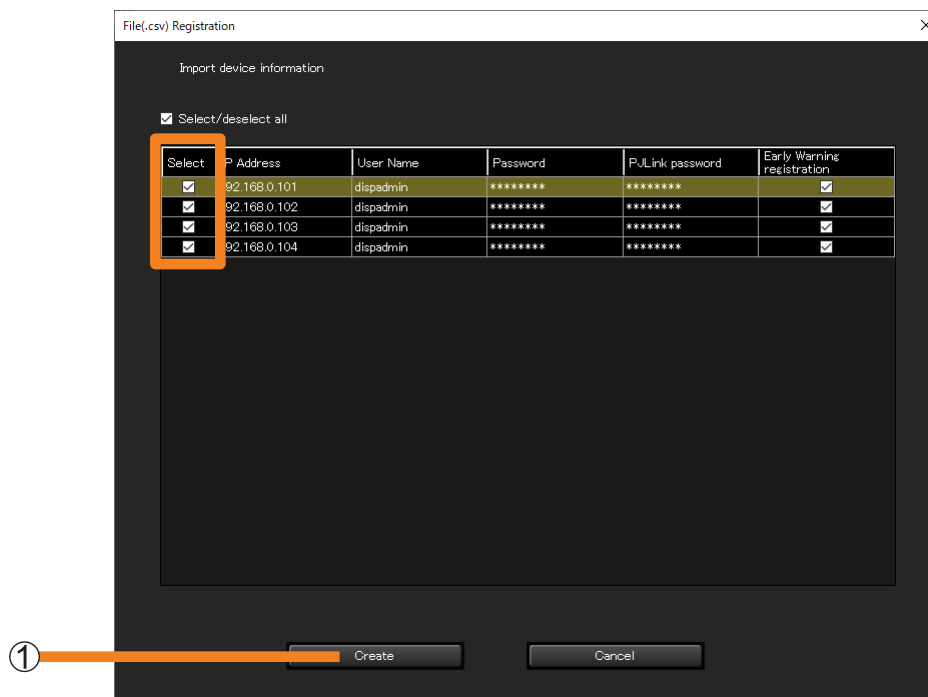

### 4 Click [Create] (1).

The registered devices will appear in the tree pane on the <Device Monitoring> window.

#### Notes

- Displaying the registered device information may take a long time.
- The passwords will be hidden behind asterisk characters (\*\*\*)
- The number of units that can be selected for early warning registration is limited by the license being used.
- Device files including devices that use a comma (,) in the user name or password cannot be imported. When registering devices that use a comma (,) in the user name or password, please register manually. (page 39)

## Registering Devices and Peripheral Devices to Monitor and Control

### Registering from “Geometry Manager Pro”

This function is used to register in this software the setup information of the projectors registered in “Geometry Manager Pro” which is a software application that supports the geometry correction and installation adjustments of the projectors.

It is useful at such times when there are a large number of projectors to be registered because it obviates the need to register the projectors again using this software.

- 1 Select [Device Management] → [Importing an external setup file] → [Geometry Manager Pro] from the menu.

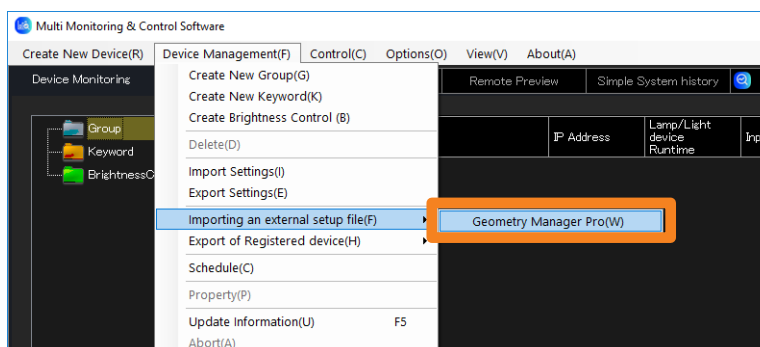

- 2 The message [The device with the same IP Address cannot be registered. OK?] is displayed.

[Yes]: If the IP address of the projector to be imported matches the IP address of a registered device, the projector will not be registered.

[No]: Cancel the import process.

- 3 Click [Select file].

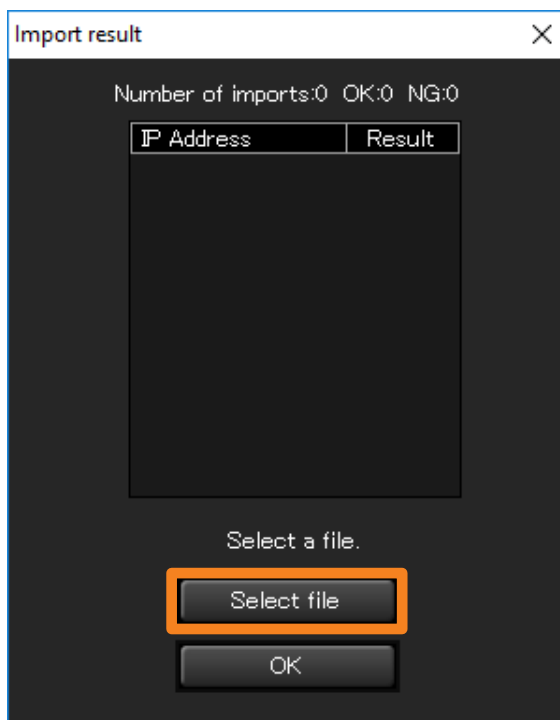



## Registering Devices and Peripheral Devices to Monitor and Control

---

- 4** Select the projector registration information file (extension: .ugk) and click [Open].
- 5** When the import results are displayed, check the contents and click [OK].
  - If importing has failed because the file is damaged, for instance, the message is displayed. Check whether there is problem in the projector registration information file.

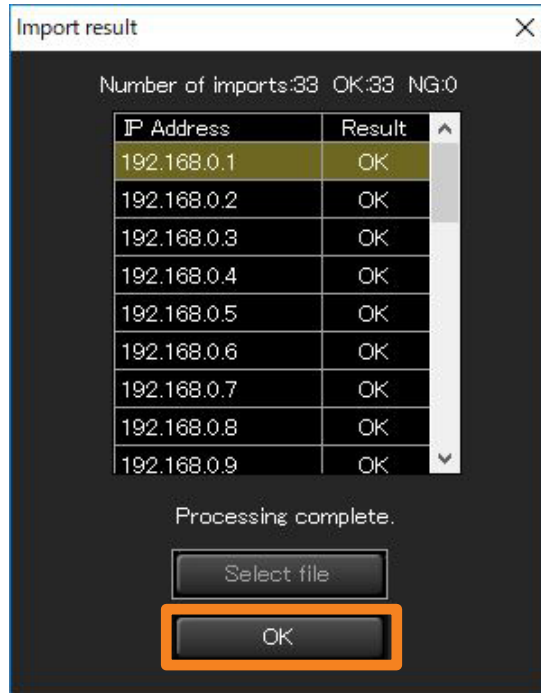



### Export device information

#### Exporting device information for Screen Transfer

It is a function that exports registered device information for Screen Transfer.

- 1 Select **[Device Management]** → **[Export of Registered device]** → **[Screen Transfer]** from the menu.

If you select menu after selecting  (group folder) or  (network camera) at the tree pane of the <Device Monitoring> window, you can only export the device information under the selected group.

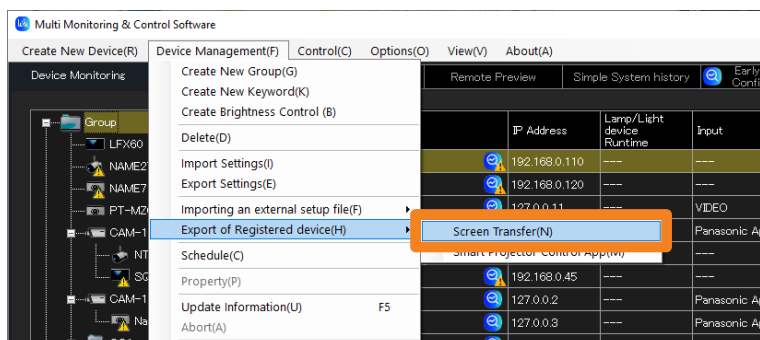

- 2 Set the save destination and file name, and click **[Save]**.

File name: DeviceList.dat

#### Exporting projector information for Smart Projector Control App linking

It is a function that only extracts projectors from registered devices, and exports related information for Smart Projector Control App linking.

- 1 Select **[Device Management]** → **[Export of Registered device]** → **[Smart Projector Control App]** from the menu.

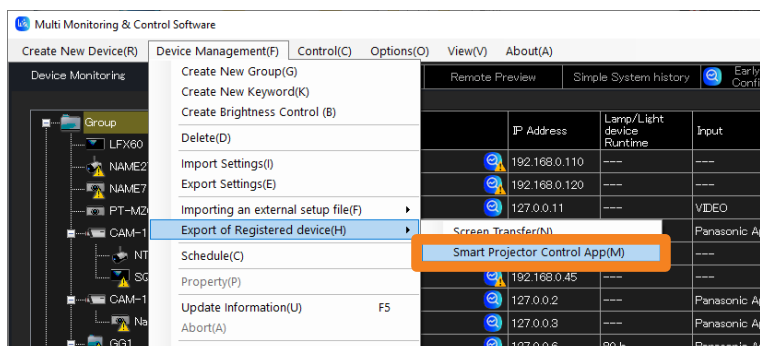

## Registering Devices and Peripheral Devices to Monitor and Control

---

**2** Select the check box of the projector or  (group folder) you want to export, and click [Export].

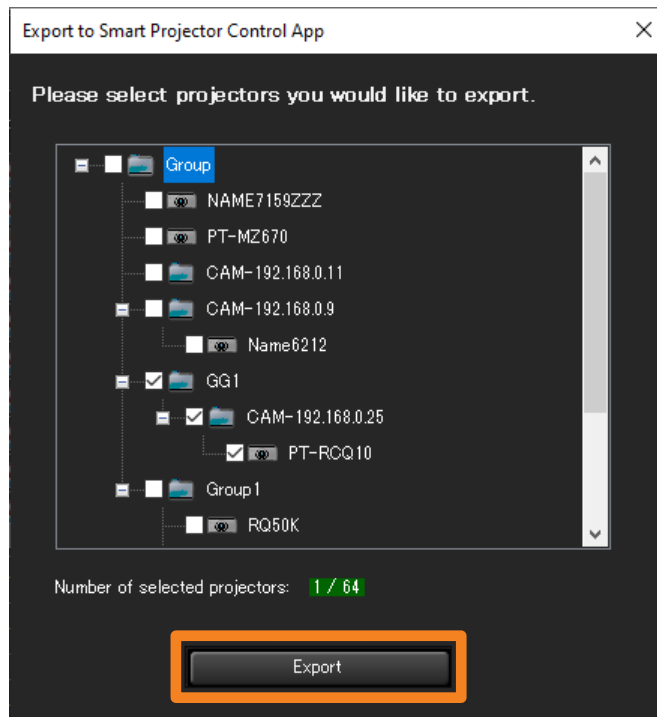

**3** Set the save destination and file name, and click [Save].

When the message of successful saving is displayed, click [OK].

File name: MMCS\_DeviceList\_XXXXXXXXXXXXXXXXX.dat

("XXXXXXXXXXXXXXXXX" is the year, month, day, hour, minute, and second.)

## Changing the Registration Information of a Device or Peripheral Device

**1** From the tree pane on the <Device Monitoring> window, select the device whose registration information is to be changed, right-click it, and select [Property].

- If you are changing a network camera's information, see page 57.

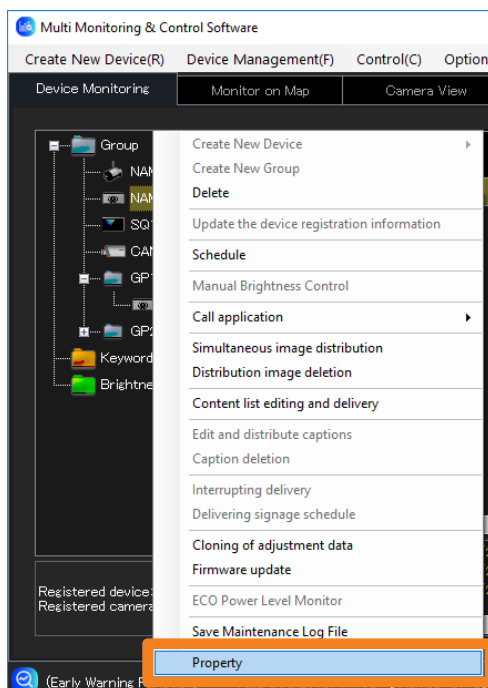

**2** Change the registered information and click [Update] (①).

- When changing the user name and password for Content Manager authentication, uncheck [Use Administrator account settings] (②) in [User name/Password for Content Manager].
- You can change the registration details of a DIGITAL LINK Switcher by clicking [Change peripheral device] (③).

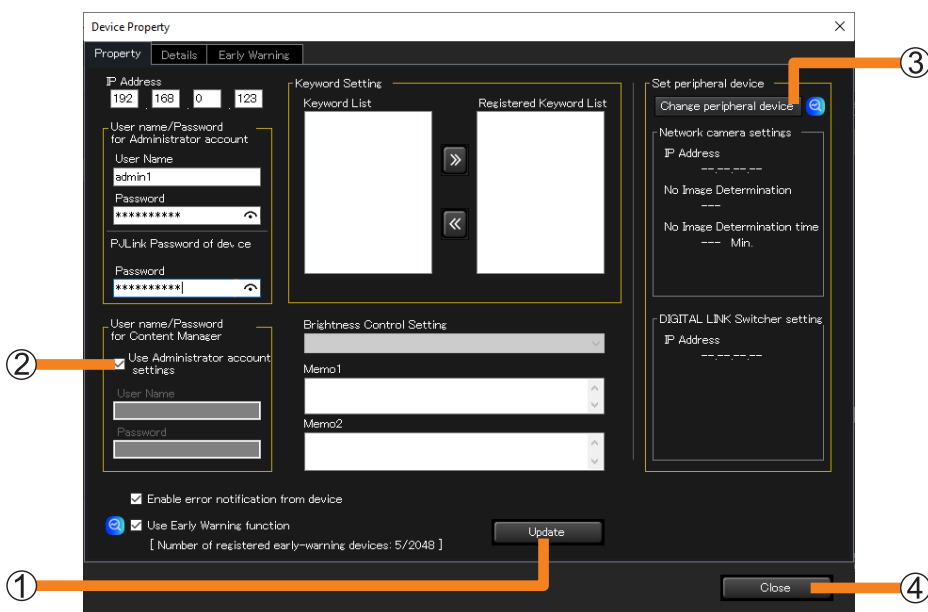

**3** Click [Close] (④).

## Changing the Device Name

You can change the registered device name.

**1** From the tree pane on the <Device Monitoring> window, select the device name you want to change, and press the [F2] key on the keyboard.

- Alternatively, you can use the following method.
  - Select the device name you want to change, and click on the device name once again.

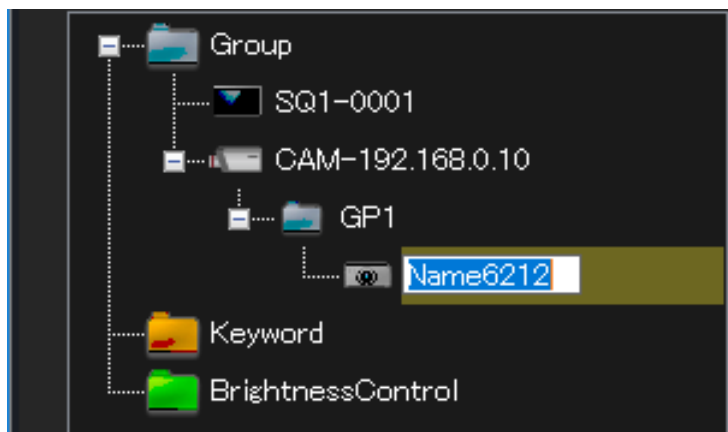

**2** Enter a new device name, and press the [Enter] key.

You can enter up to 8 half-width upper-case letters or numerals for a flat panel display and up to 12 for a projector.

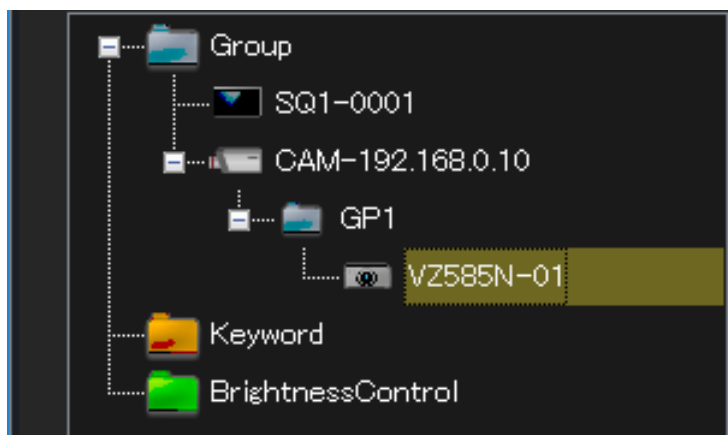

### Notes

- If you change the device name on the software side, the device name on the device side will also be changed. For devices that does not support the change device name function, the device name will change back even if you change the device name.

## Register a network camera

You can individually register a network camera as a peripheral device. (Maximum of 32)  
 • To link a registered network camera to devices or group folders, see page 56.

- 1 Select **[Create New Device]** → **[Network camera registration]** from the menu.

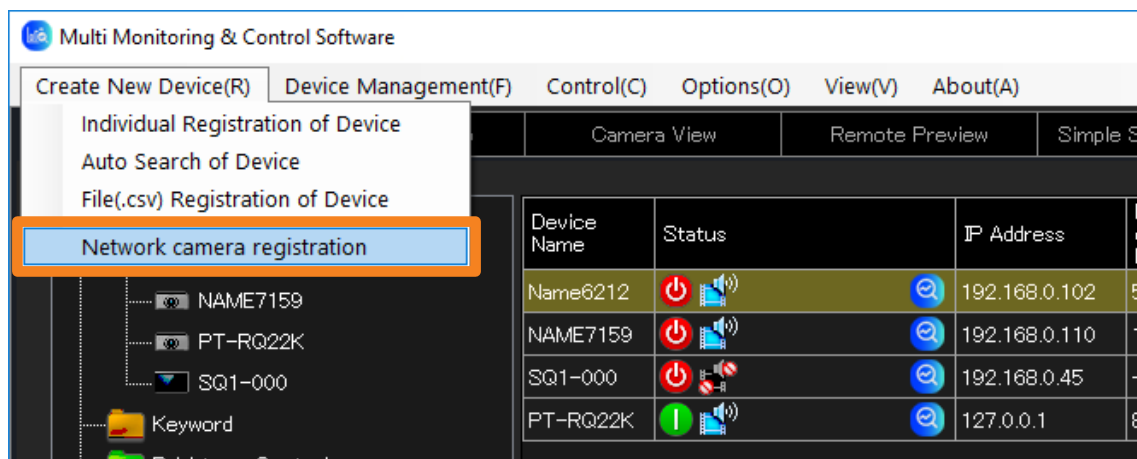

- 2 Enter the set **[IP Address]**, **[User Name]**, and **[Password]** of the network camera you will register.

Network camera registration

Network camera

IP Address: 192.168.0.

User Name: \_\_\_\_\_

Password: \_\_\_\_\_

Network camera Name: \_\_\_\_\_

Memo: \_\_\_\_\_

Create

Close

## Register a network camera

---

### 3 Enter [Network camera Name] and [Memo] as necessary then click [Create].

[Network camera Name]: You can enter a maximum of 32 characters.

[Memo]: You can enter a maximum of 512 characters.

### 4 Click [Close].

 and the [Network camera Name] (CAM-XXX (XXX: network camera's IP address) will be displayed if not entered) entered in Step 3 will be displayed on the tree pane of the <Device Monitoring> window.

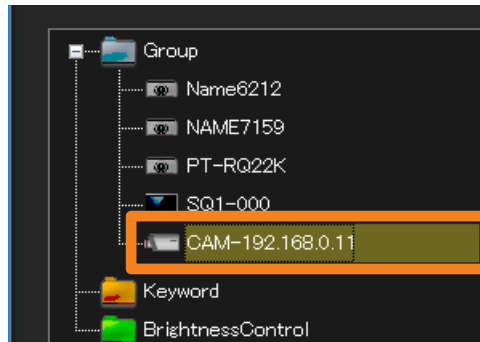

## Register a network camera

### Linking a device

By linking a registered network camera to a device or group folder, you can monitor devices with video.

#### ■ To link devices or group folders that are already registered

**1** Drag the device icon or  (group folder) you want to link directly under  and drop it.

- When you move a group, the groups or devices under the group will also move together.
- Up to 99 hierarchical levels can be set for the groups.

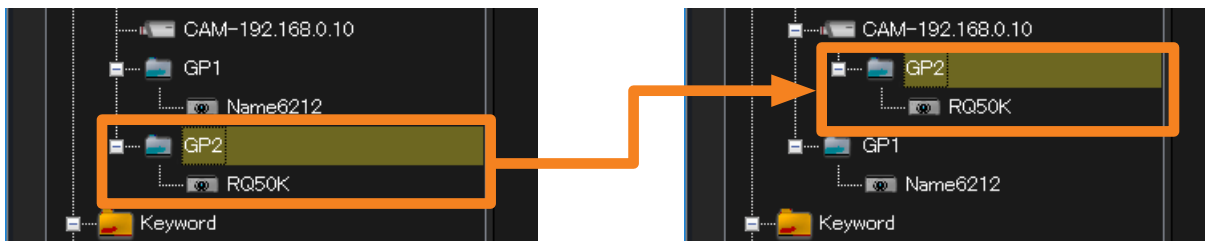

#### ■ To create and link new devices and group folders

**1** Select the  you want to link then right-click it and select [Create New Device] or [Create New Group].

For further steps, see the following pages.

- [Create New Device] (page 39)
- [Create New Group] (page 60)

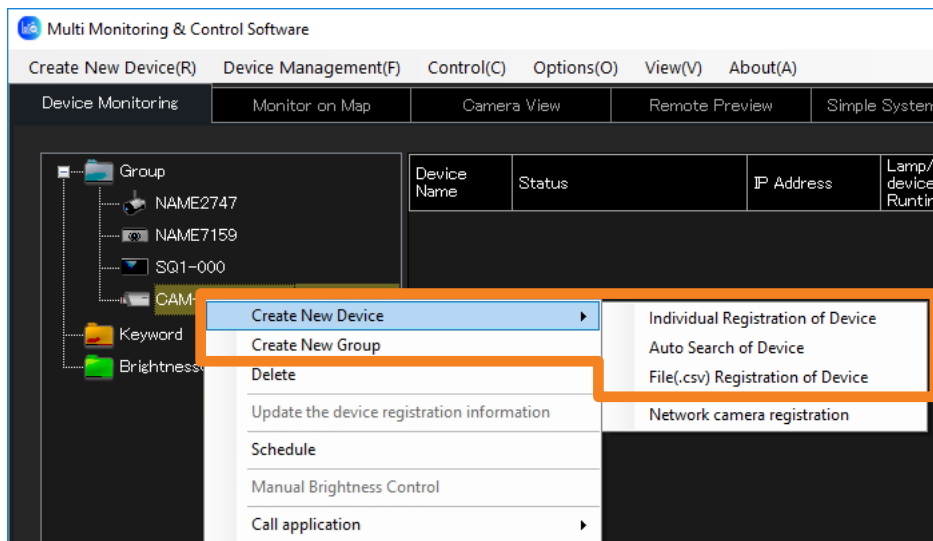

### Notes

- You cannot directly link a network camera to another network camera.
- To display a registered network camera's video as an image, see page 91.



## Changing the Registration Information of a Network Camera

- 1 Select the  (network camera) of the registration information you will change then right-click it and select [Property] from the tree pane of the <Device Monitoring> window.

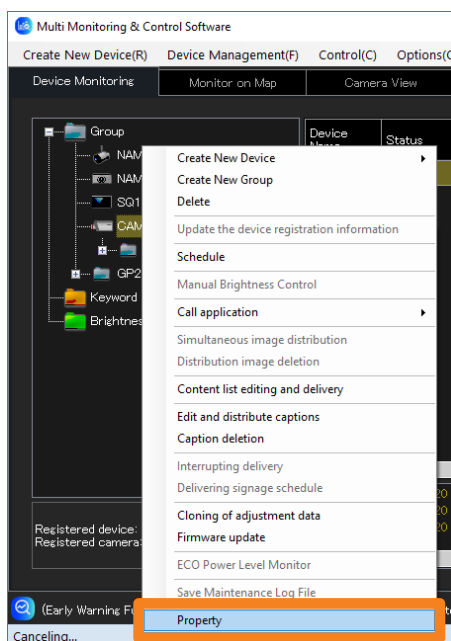

- 2 Change the registered information and click [Update] (①).

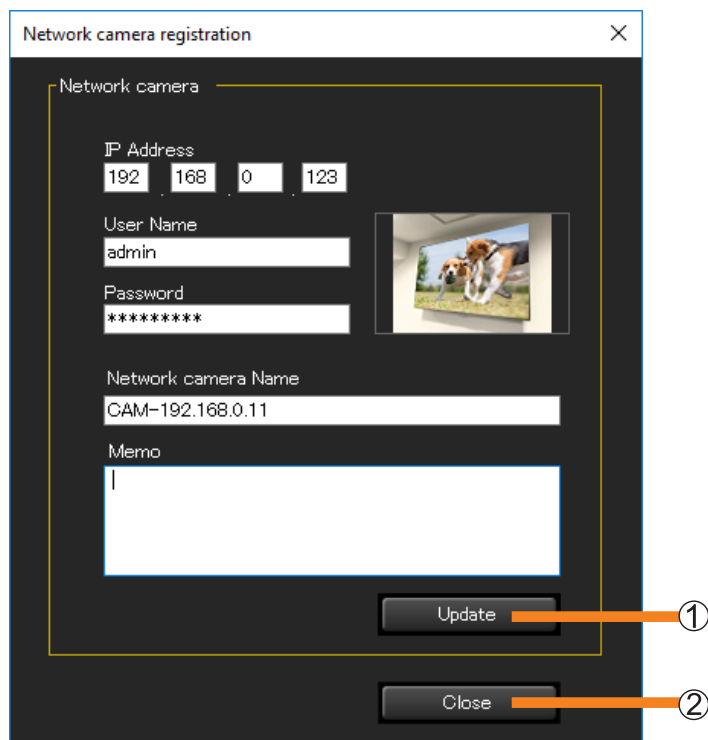

- 3 Click [Close] (②).

## Setting up the Fail Soft Function

If the video signal is momentarily interrupted, resulting in a continuing no-signal condition, the fail soft function on flat panel displays performs recovery processing automatically so that video continues to be displayed.

To enable the fail soft function, select one of the following.

**[Enable hot plug reset processing.]:**

The video signal is redetected for the selected input. (Normally, you would select this option.)

**[Enable hot plug reset processing and power supply reset processing.]:**

If recovery is not possible using hot plug reset processing, the device is powered off and then back on again.

### Notes

- Enabling the fail soft function is recommended in cases where video content is played continuously over an extended period of time, such as signage applications. This function will automatically attempt to recover if an unanticipated no-signal condition occurs.
- Do not use the fail soft function in usage situations where video content is not played continuously and sometimes there is no input signal. This software will display a notification each time automatic recovery processing occurs, whether or not it is necessary.
- If recovery from a no-signal condition often fails even when [Enable hot plug reset processing.] is selected, select [Enable hot plug reset processing and power supply reset processing.] instead.
- For flat panel displays that support the fail soft function.  
To see if a flat panel display being used is supported, refer to the “List of Compatible Device Models” of this application software which is posted on the following website.  
<https://panasonic.net/cns/prodisplays/download/software/>

- 1 From the tree pane on the <Device Monitoring> window, select the flat panel display to which the fail soft function is to be set, right-click it, and select [Property].

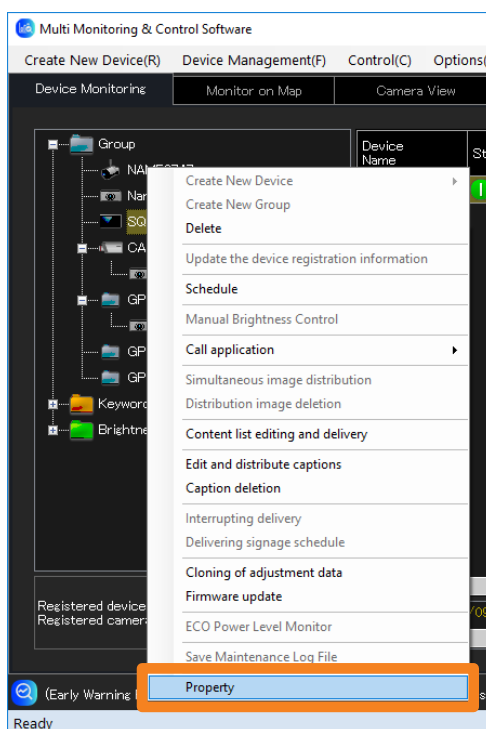

## Setting up the Fail Soft Function

### 2 Open the [Early Warning] tab, and select functions ① by checking them.

**[Enable hot plug reset processing.]:**

The video signal is redetected for the selected input. (Normally, you would select this option.)

**[Enable hot plug reset processing and power supply reset processing.]:**

If recovery is not possible using hot plug reset processing, the device is powered off and then back on again.

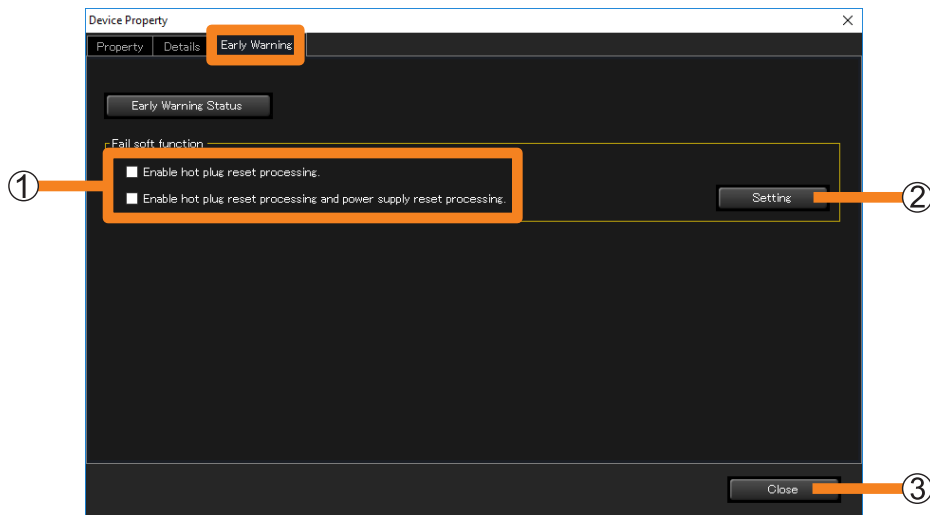

### 3 Click [Setting] (②).

After changing settings, the following message is displayed. Click [OK].

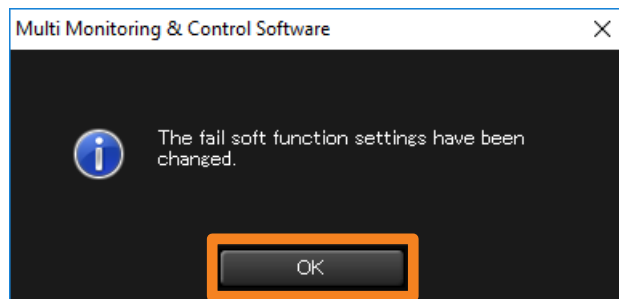

### 4 Click [Close] (③).

#### Notes

- The fail soft function is not guaranteed to prevent all situations in which video display stops.
- The fail soft function can be used when the video input signal being input to the flat panel display is a digital signal.
- The interval of the fail soft function is updated depends on the [Interval Time of Device Information] (page 229) setting.  
 Example) If you set the [Interval Time of Device Information] to 60 minutes  
 Even if the video connection momentarily cuts off and is in a no-signal condition, the software will not be able to recognize the momentary no-signal condition between the 60 minutes the device information is being automatically retrieved till the next automatic retrieval.
- Enabling the fail soft function also requires making settings on the flat panel display.

## Creating a Group

Use the steps below to manage specific groups of devices, for example by floor or by type. A total of 100 groups can be created.

### 1 Select (group folder) from the tree pane on the <Device Monitoring> window, right-click it, and select [Create New Group].

- Alternatively, you can use the following method.
  - Select [Device Management] → [Create New Group] from the menu.

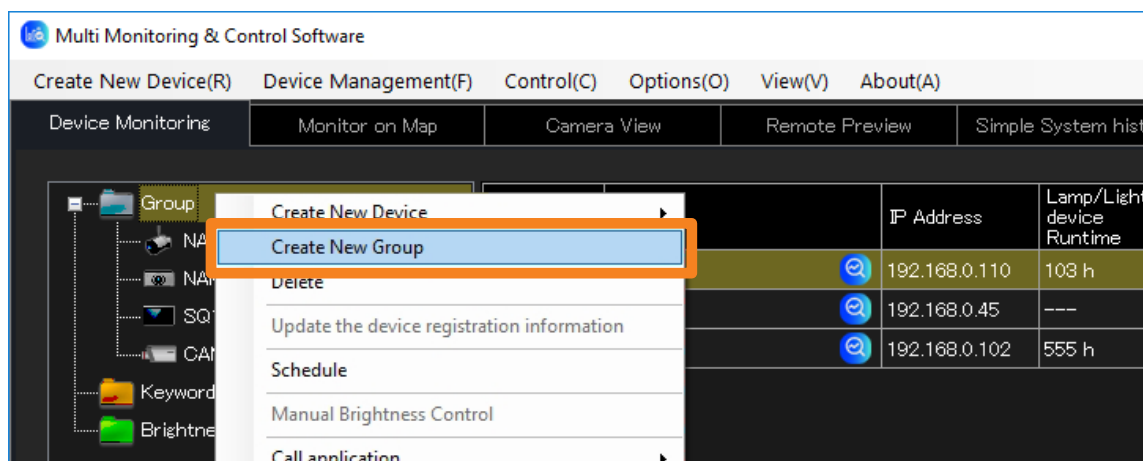

### 2 Enter a [Group Name].

You can enter up to 128 characters.

- [Memo] may be added if desired. You can enter up to 512 characters.

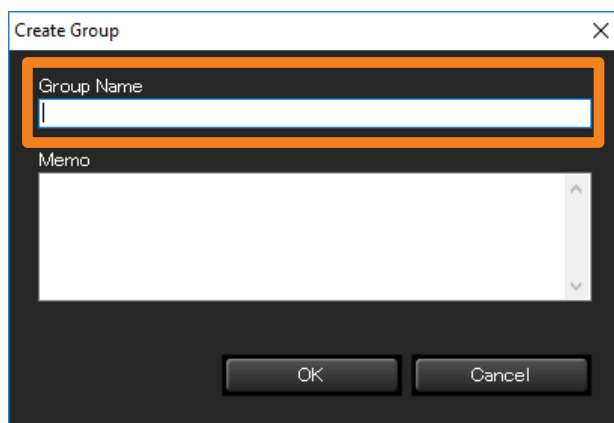

### 3 Click [OK].

A new group icon will be created in the tree pane.

#### Notes

- The same name may be used for more than one group.

## Creating a Group

### Moving a group

**1** Drag the device icon and drop it under the  (group folder) where you want to register it.

- When you move a group, the groups or devices under the group will also move together.
- Up to 99 hierarchical levels can be set for the groups.

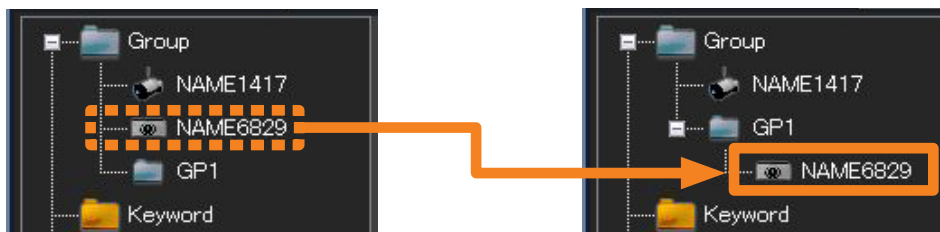

Moving registered devices to a different group

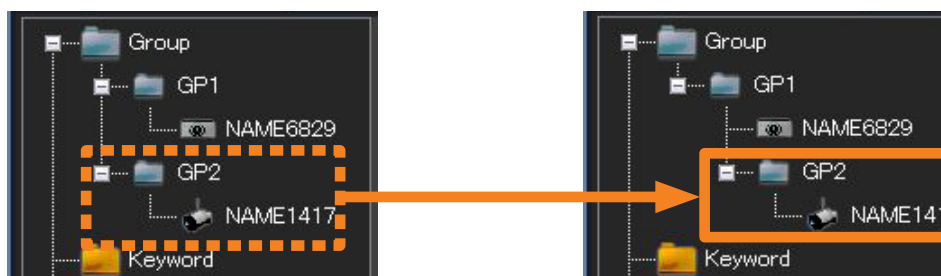

Moving by Group

### Newly register a device under a group

**1** Select the  (group folder) you want to register then right-click it and select [Create New Device] or [Create New Group].

For further steps, see the following pages.

- [Create New Device] (page 39)
- [Create New Group] (page 60)

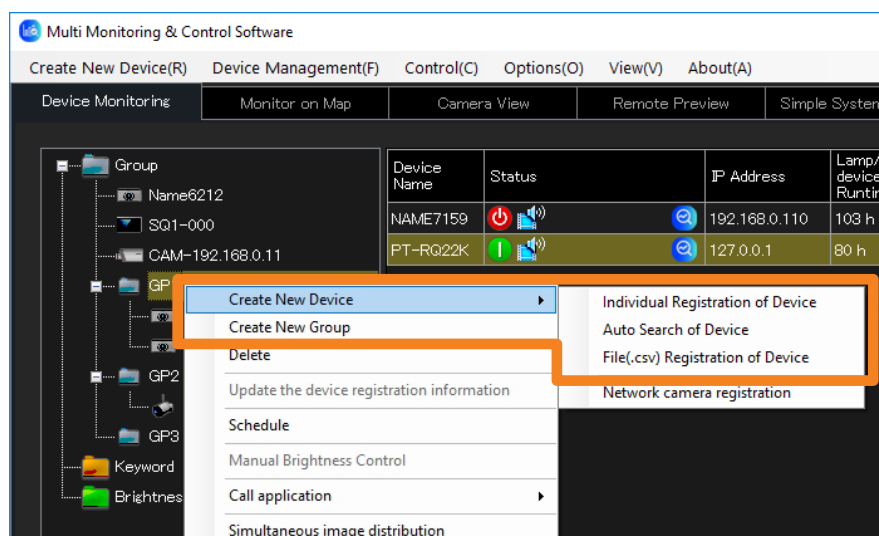

## Creating a Keyword

You need to create the keyword first when you want to monitor and control the devices as a keyword unit.

**1 Select [Device Management] → [Create New Keyword] from the menu.**

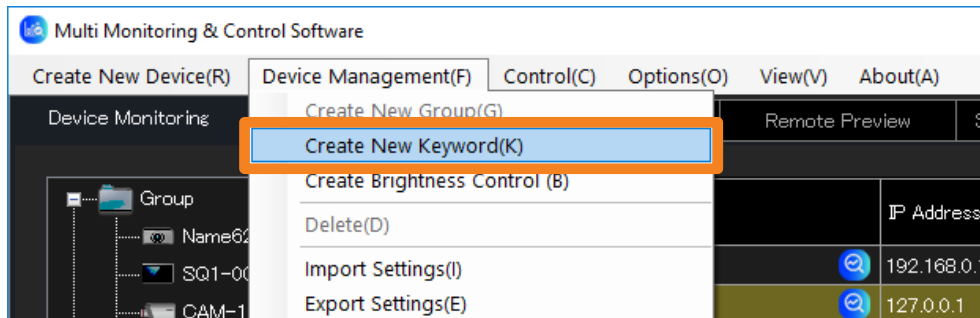

**2 Enter the [Keyword].**

A character string of your choice of up to 128 single-byte characters may be used.  
 • [Memo] may be added if desired. You can enter up to 512 characters.

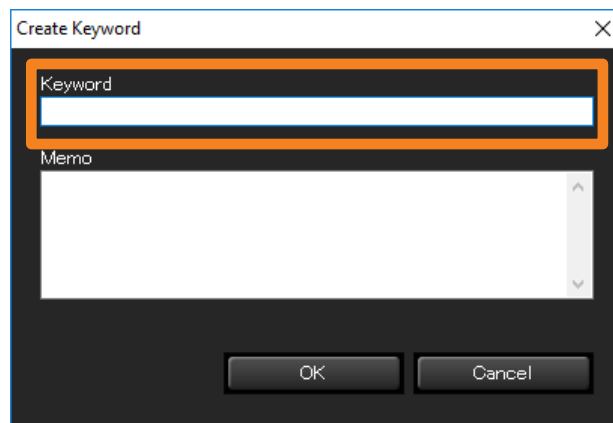

**3 Click [OK].**

A new keyword icon will be created in the tree pane.

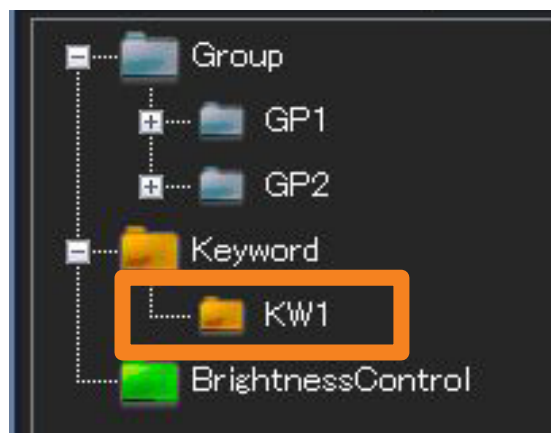

## Creating a Keyword

### Assigning a Keyword to a Device

**1** From the tree pane on the <Device Monitoring> window, select the device you want to assign a keyword to, right-click it, and select [Property].

- Alternatively, you can use the following method.
  - Select [Device Management] → [Property] from the menu.
  - Select the device in the Brief information display pane, right-click it, and select [Property] in the displayed menu.

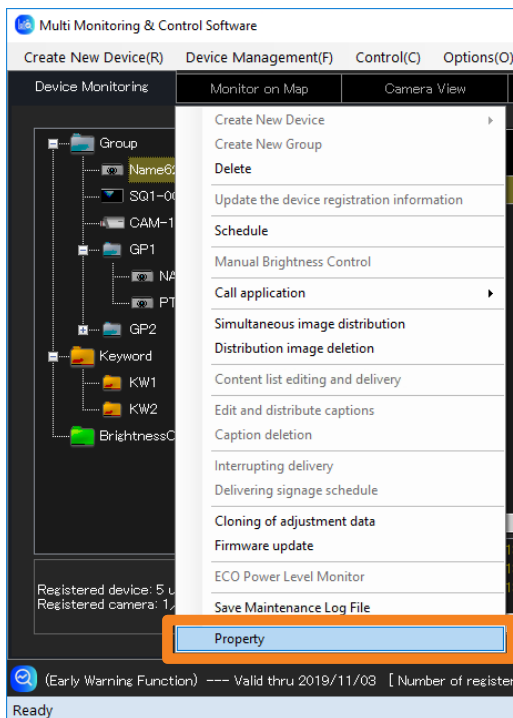

## Creating a Keyword

**2** Open the [Property] tab, select the keyword you want to assign from [Keyword List], and click **»**.

The selected keyword will move to the [Registered Keyword List] on the right side. If you click **«**, it will return to the left side.

- In order to assign multiple keywords, repeat the process above for each keyword.

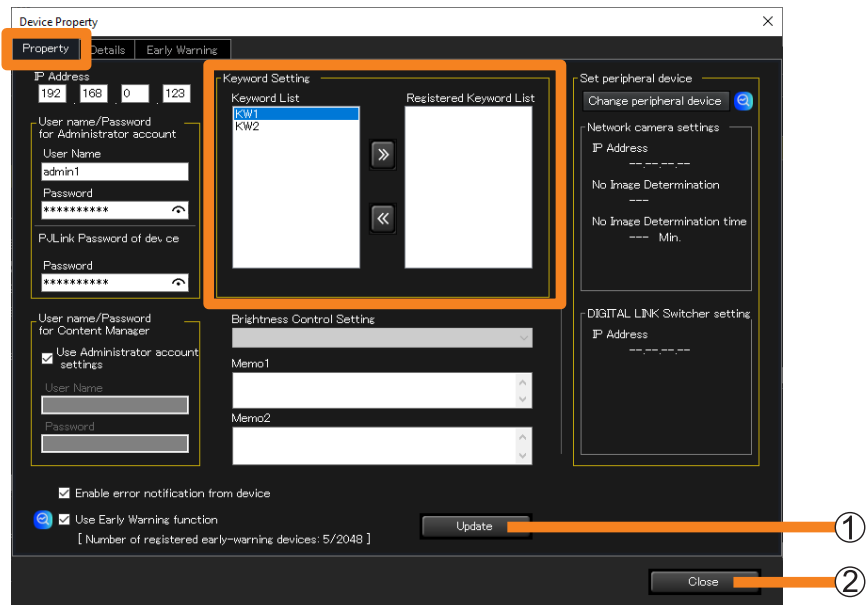

**3** Click [Update] (①).

**4** When the “update successful” message appears, click [OK].

**5** Click [Close] (②).



## Creating Brightness Control

Brightness control can be registered to prevent the brightness on the projected screen from being inconsistent between each projector as a result of individual characteristics and time degradation of lamps when, for example, a group of projectors are used to display one integrated image.

- 1 Select **[Device Management]** → **[Create Brightness Control]** from the menu.

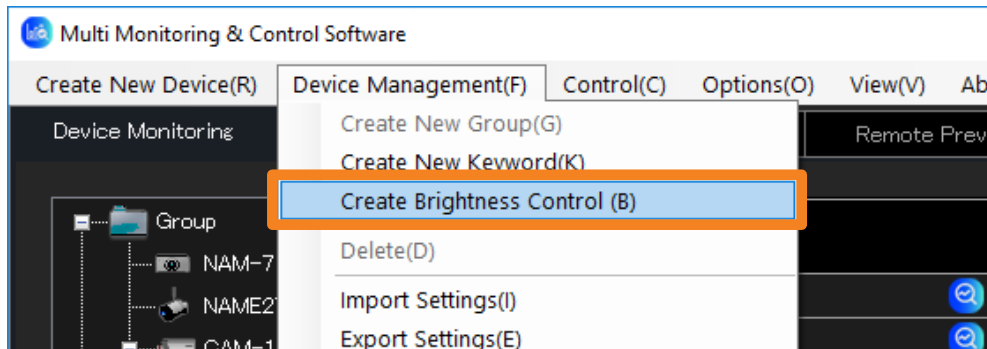

- 2 Enter a **[Brightness Control Name]**.

A character string of your choice of up to 128 single-byte characters may be used.

- [Memo] may be added if desired. You can enter up to 512 characters.

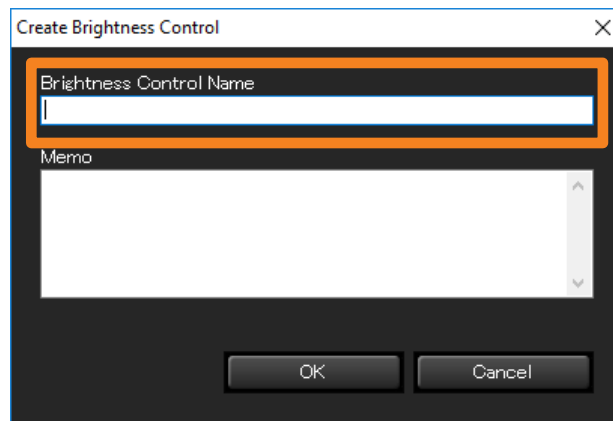

- 3 Click **[OK]**.

A new brightness control icon will be created in the tree pane.

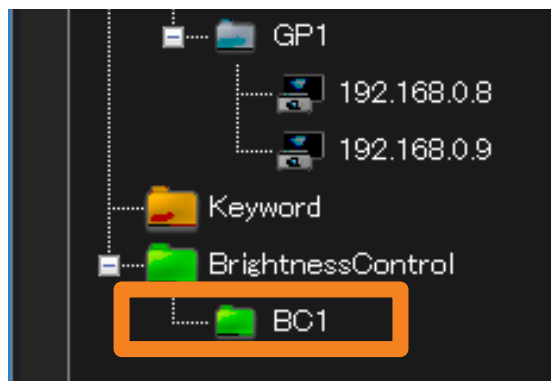

## Creating Brightness Control

### Assigning brightness control to a projector

- 1 From the tree pane on the <Device Monitoring> window, select the projector you want to assign a brightness control to, right-click it, and select [Property].
  - Alternatively, you can use the following method.
    - Select [Device Management] → [Property] from the menu.
    - Select the projector displayed on the Brief Information Display, right-click it, and select [Property] from the displayed menu.

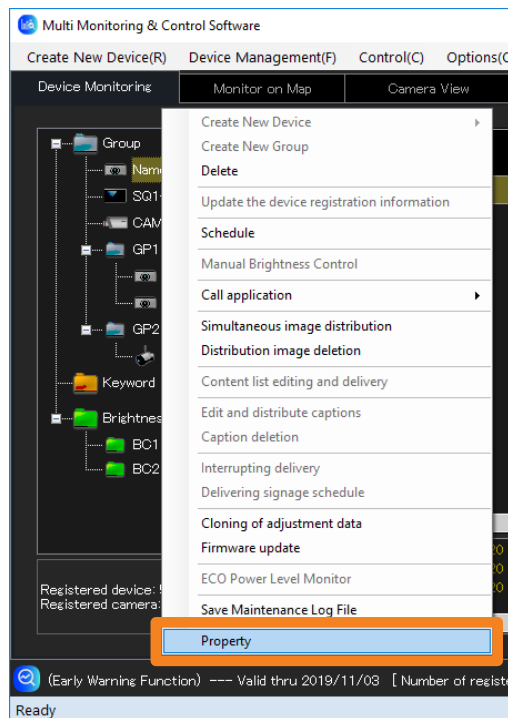

#### Notes

- The same brightness control cannot be assigned to projectors of different series. Assign a different brightness control to each projector series.

## Creating Brightness Control

### 2 Open the [Property] tab and select the brightness control you want to assign from [Brightness Control Setting].

The brightness controls that are already created will be listed. (page 65)

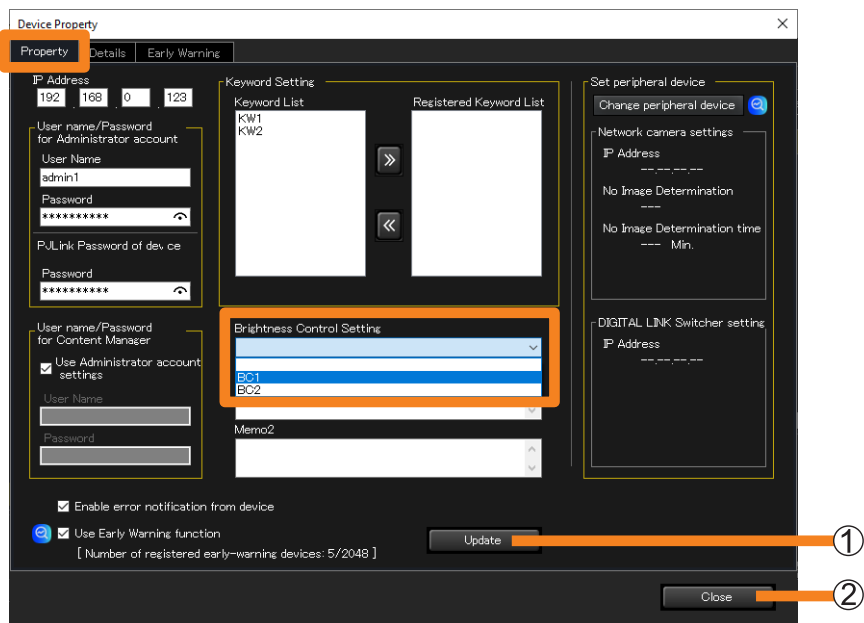

### 3 Click [Update] (①).

### 4 When the “update successful” message appears, click [OK].

### 5 Click [Close] (②).

#### Notes

- Assignment of brightness control is possible only for projectors equipped with a brightness control function. The pull-down menu will not appear for projectors without this function.
- To assign the brightness control, from the [MAIN MENU] of the projector’s onscreen menu → [PROJECTOR SETUP] → [Brightness Control] → [Brightness Control Setting] → [Mode] (or [Fixed Mode]) set to “PC”.
- The brightness control that has been assigned to a projector in a series different from that of the selected projector will not be displayed in [Brightness Control Setting].

## Updating Device Registration Information

If a device with a different model name from the registered device is detected such as when replacing the device already registered with this software with a device with the same IP address, administrator account (user name and password) and PJLink (password), the “Connected icon of a different model” is displayed in the Brief Information Display pane of the <Device Monitoring> window (page 77).

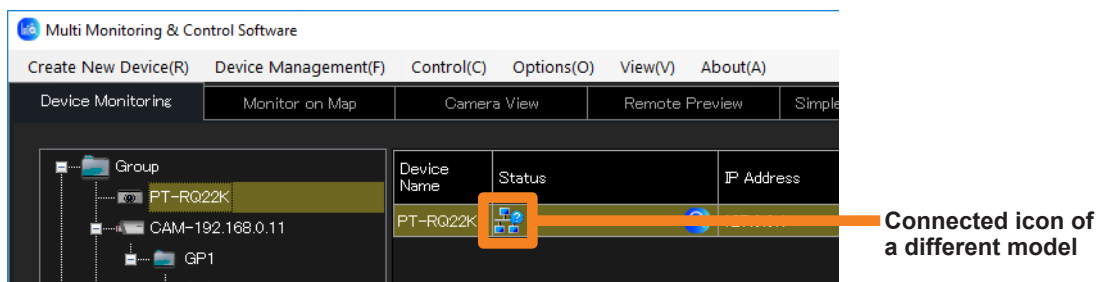

When registering a device with a different model name by replacing the previously registered device, perform the following procedure.

- 1 From the tree pane on the <Device Monitoring> window, select the device that is marked with the icon, right-click it, and select [Update the device registration information].

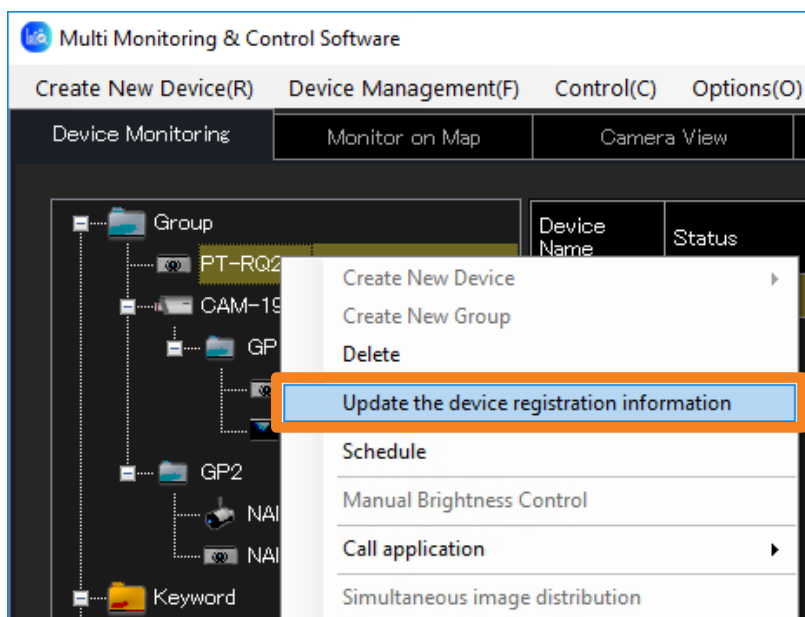

## Updating Device Registration Information

- 2 Check the user name, password, keyword setting, memo, etc., and if there is no problem, click [Update].

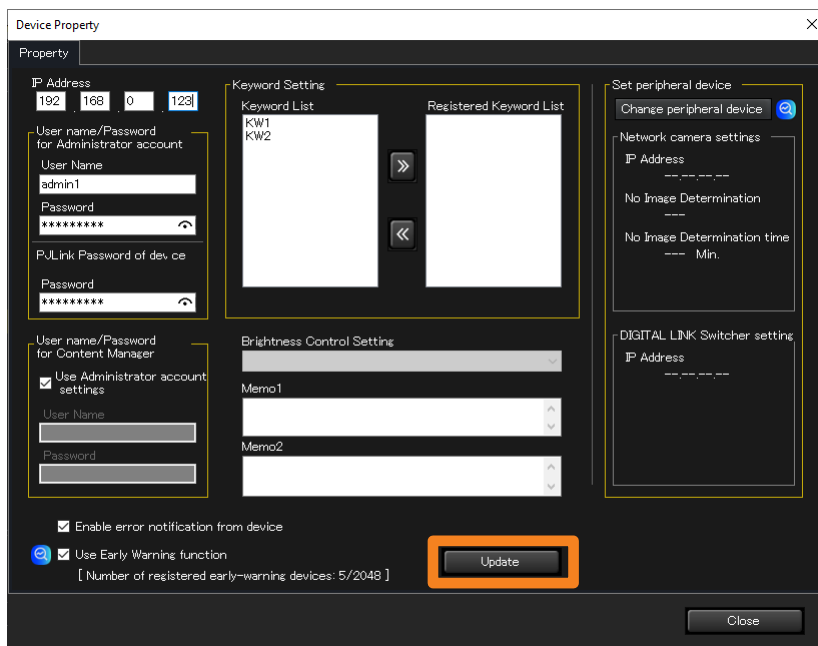

- 3 Click [Update] updates the device registration information. The message that is displayed differs in each of the cases of (a), (b), (c), and (d).

- (a) When the update is complete successfully

The following message appears if the updating of the registration information is successful.

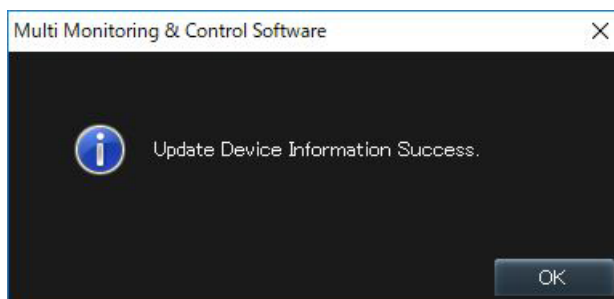

- (b) When a device to which brightness control is assigned is updated to a device that does not support brightness control, or the brightness control adjustment mode of the device to be updated is set to other than "PC" mode.

Then the following message is displayed.

Clicking [OK] updates the device registration information in the state where the device to be updated is excluded from the brightness control target.

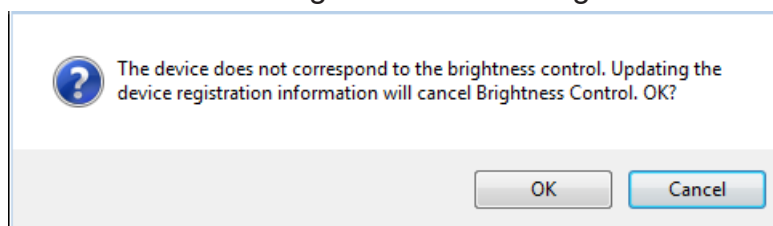

## Updating Device Registration Information

---

- (c) **When a device scheduled for [Simultaneous image distribution] or [Distribution image deletion] is updated to a device that does not support the image distribution function.**

Then the following message is displayed.

Clicking [OK] updates the device registration information in the state where the corresponding schedule is deleted from the device to be updated.

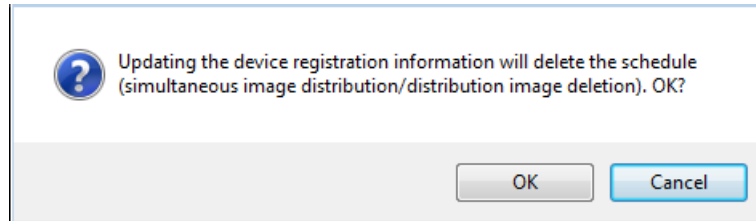

### Notes

- When the schedule is set to a group folder, the message will not be displayed even if it is updated to a device that does not support the image distribution function.

- (d) **When the update failed**

When updating the registered information fails, the following message is displayed.

- Confirm the following settings of the device to be updated.
  - [User Name] and [Password] of the administrator account
  - [Password] of the PJLink
- When an administrator account is not set on a administrator account supported device, set an administrator account according to the warning message. (page 45)

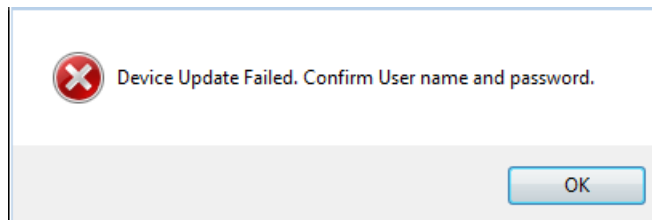

### Notes

- The group folder or keyword settings registered for the device will be transferred as-is after the update.
- The previously registered device schedule will be transferred as-is. If brightness control is released, then the schedule of brightness control is not taken over.
- If schedule for operation of a function not available with the updated device is taken over, then the function is not operated and results in error when the schedule is performed.

## Deleting (A device, group, keyword, brightness control, or network camera)

**1** From the tree pane of the <Device Monitoring> window, select the icon of the device, group, keyword, brightness control, or network camera to be deleted, right-click it, and select [Delete].

- Alternatively, you can use the following method.
  - Select [Device Management] → [Delete] from the menu.
- When you select a folder, the folder and all its contents are deleted. (A parent group ([Group] folder) cannot be deleted.)

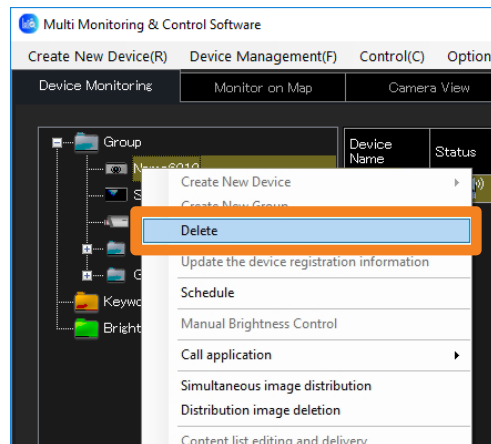

**2** When the confirmation message is displayed, click [Yes].

The selected item is deleted from the tree pane.

## Registering Device Location Information

You can arrange registered devices on the map in groups in order to visually check their installation status. You can also select devices from the map to carry out device control or schedule registration.

### 1 Open the [Monitor on Map] tab and select the [Group] tab to import the map.

All the existing groups including the parent group ([Group] folder) will be displayed in the tab.

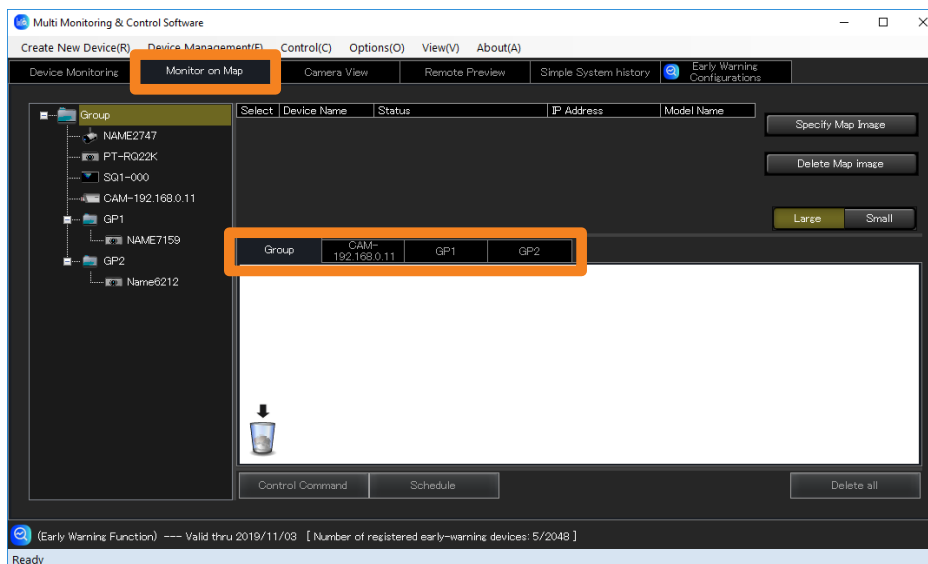

### 2 Click [Specify Map Image] (1) and select the map to import.

Select an image and click [Open] to import the image into the selected group.

- Selectable image files
  - Extension: .jpg/.jpeg/.png/.bmp
  - Maximum number of pixels: 4,096 × 4,096
- To switch the map, click [Specify Map Image] again and select another image. You can also switch images after the devices are installed.

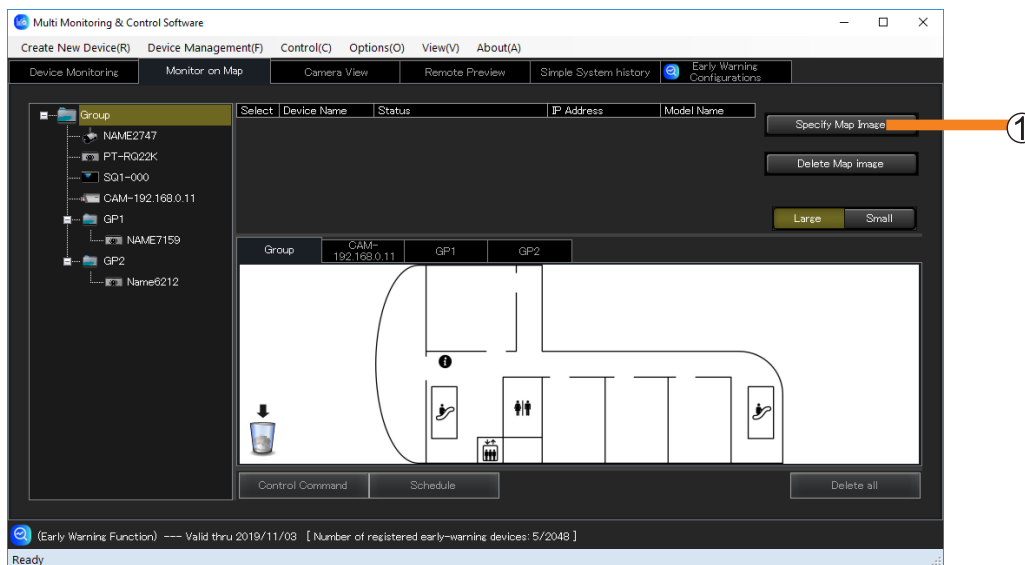



## Registering Device Location Information

### 3 Drag and drop devices from the tree pane onto the map.

A list of the placed devices is displayed (②).

- Click [Large] or [Small] (③) to enlarge or reduce the size of the placed icons.
- Selecting the check box (④) of a device icon on the map causes the corresponding check box in the [Select] column on the device list information side to be selected as well. (It is not possible to select check boxes in the device list information selection column directly.)
- Devices can be placed inside the registered group tab.
- Group folders can be placed in a registered group one level higher.

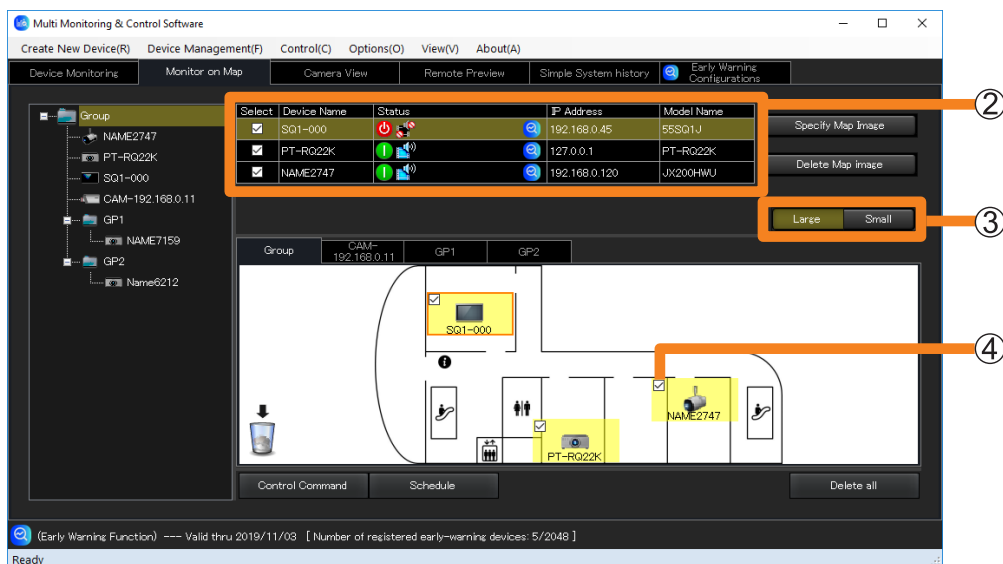

## Registering Device Location Information

### Deleting a device or group folder that has been placed on a map

**1** Select the device or group folder to delete, and drag and drop it onto the trash can (①).

- To delete all devices or group folders all at once, click [Delete all] (②).

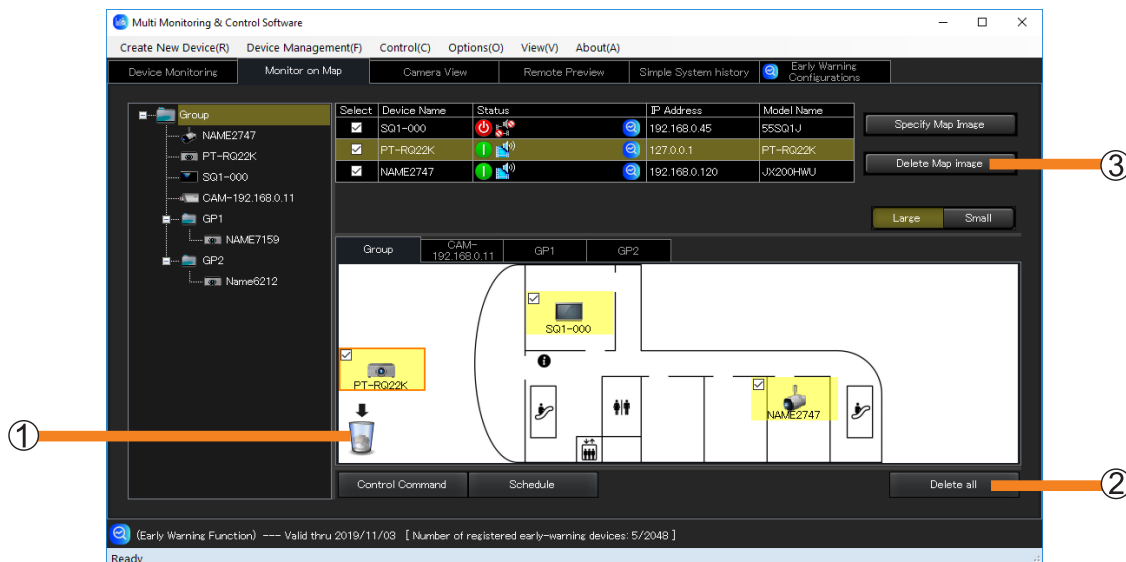

**2** When the confirmation message is displayed, click [Yes].

The device moved to the trash can will be deleted from the map.

### Notes

- If you click [Delete Map image] (③), the map image will disappear, but the placed devices and group folders will remain.

## Registering Device Location Information

### Performing device control and scheduling from the map

- 1 Select the group tab where the devices to be configured were placed.
- 2 Select the check boxes of the devices and group folders to be configured and click [Control Command] (①) or [Schedule] (②).

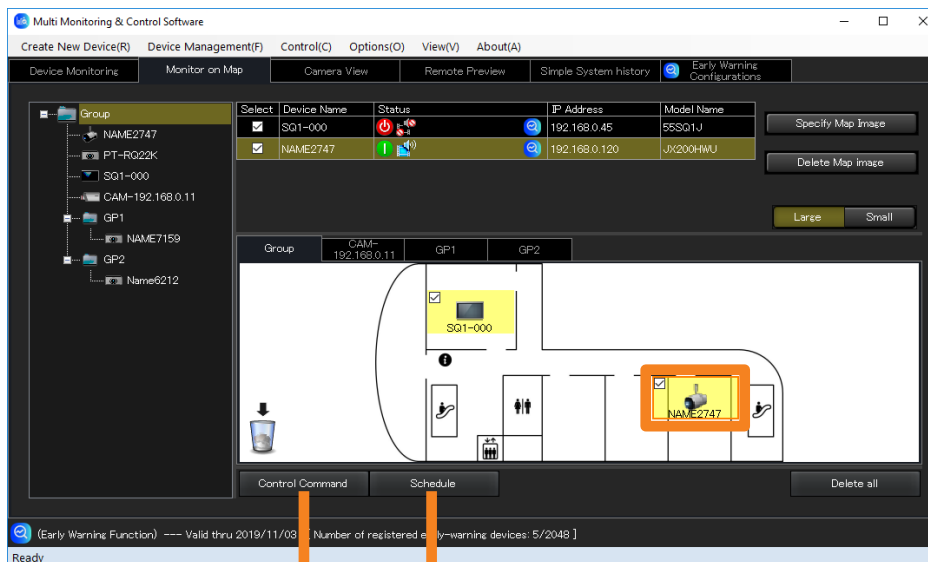

- 3 (When [Control Command] is selected)  
Follow the steps in “Executing a Control Command” (page 112) to configure the control settings.

(When [Schedule] is selected)  
Follow the steps in “Scheduling Function” (page 122) to configure the schedule settings.

## Registering Device Location Information

### Displaying the Early Warning function

1 Select a device and click  icon (①).

This function displays detailed information about early warnings related to selected devices.

- You can select devices from the list or from the map.

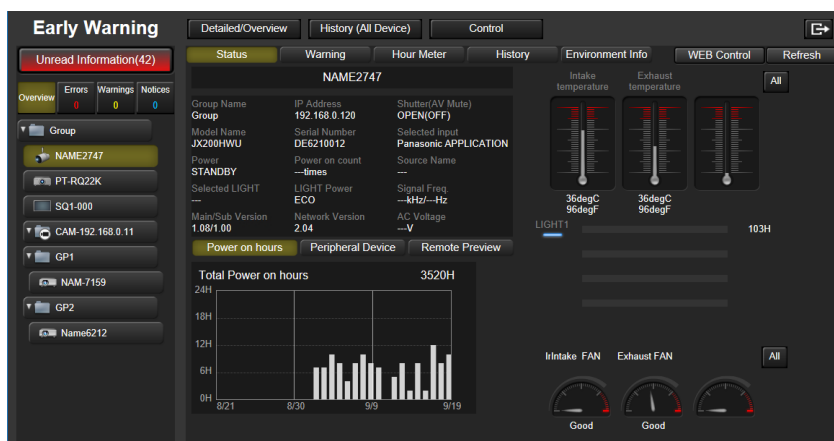
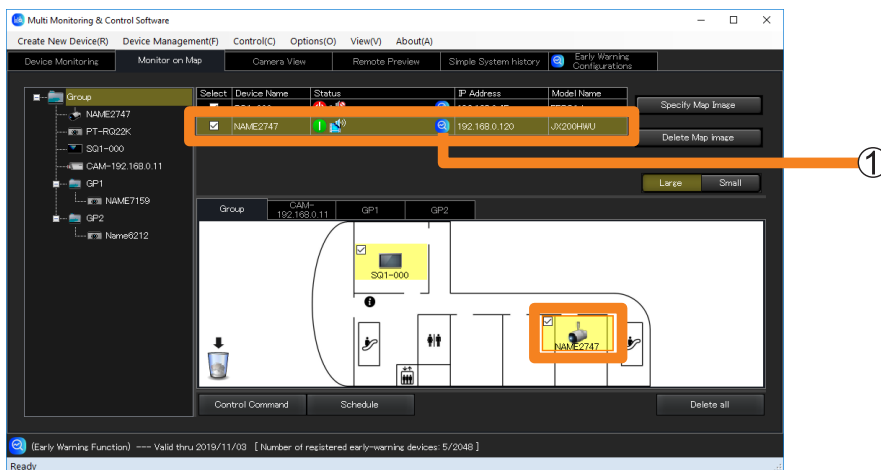

# Monitoring Function

## About the Brief Information Display

The <Device Monitoring> window displays brief information relating to the registered devices as a Group/Keyword/Brightness Control unit.

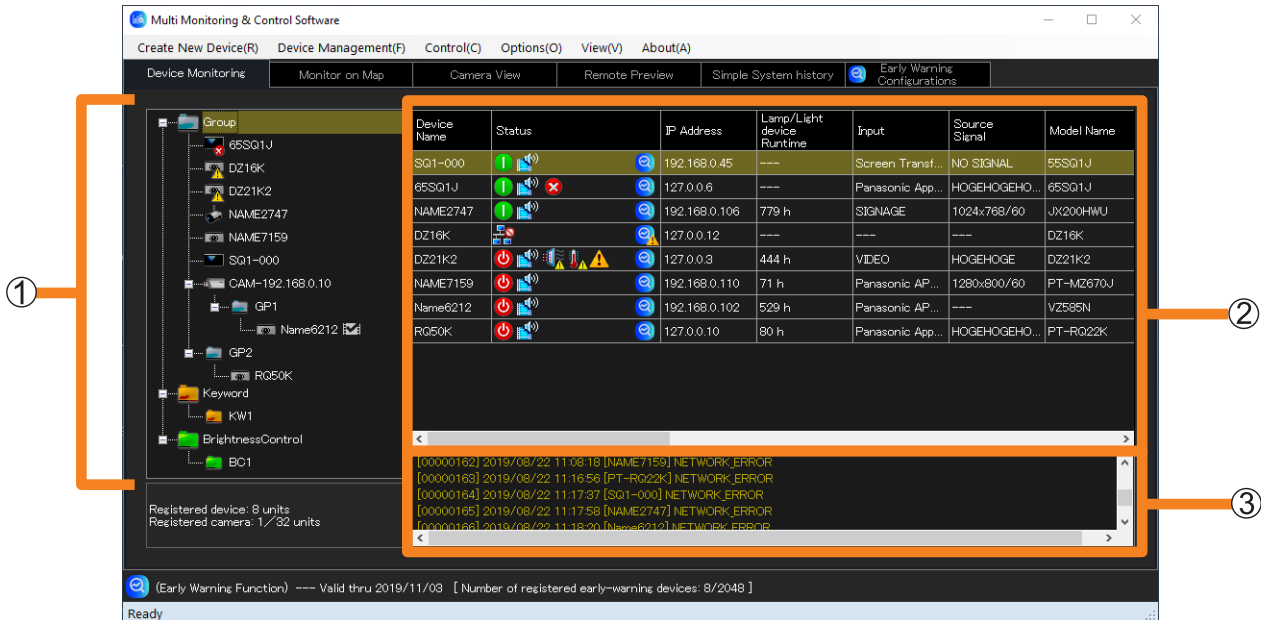

<Device Monitoring> window















- ① **Tree pane** (page 78)
- ② **Brief information display pane** (page 79)
- ③ **Command execution display pane:** Displays the execution results of the control command (page 112), scheduling function (page 122), connection status and the log history information of the devices.

### Notes

- Regardless of the connection environment such as wired connection/wireless connection, when the communication environment is unstable, the device information may not be properly retrieved.

## About the Brief Information Display

## Icons in the tree pane

Device		Device is in a normal status.
		Device is in a warning status. (Details of warning are displayed in the Brief information display pane to be confirmed.)
		Device is in an error status. (Details of errors are displayed in the Brief information display pane to be confirmed.)
		The device has a notification. (The notification can be viewed using the early warning function.)
		When you link a registered network camera to a device, and then set the video stop determination, this icon is displayed to the right side of the device name.
Network camera		A network camera is registered.
		An error has been detected with the connection of the network camera.
Group		A group has been made.
		More than one device is in a warning status in the group.
		More than one device is in an error status in the group.
		More than one device in the group has notifications.
Keyword		A keyword has been made.
Brightness control		A brightness control has been created.
		There are one or more projectors in the group for which brightness control failed to execute properly and a warning was detected.
Schedule		A schedule has been set up to the device, group, keyword, or brightness control.

## Notes

- When both a warning and an error are detected simultaneously from the same device, the error icon will be displayed. Also when a warning and an error occur simultaneously in the group, the icon is indicated as an error.
- Depending on the flat panel display model, when a warning or error has occurred, or a new warning or error occurs, icons that indicate the warning or error will not appear in the tree pane on the <Device Monitoring> window and the normal status icon will be displayed instead. For details on the models for which this limitation applies, refer to the “List of Compatible Device Models” of this application software which is posted on the following website.  
<https://panasonic.net/cns/prodisplays/download/software/>  
You can view information on all device warnings or errors that have occurred under the [Self Test] item in the [Details] tab of the [Device Property] window. (page 89)











## About the Brief Information Display

## Icons in the Brief information display





**[Device Name]:** Displays the projector name (host name) set for each device or displays the display name (host name) set for each flat panel display.

**[Status]:** Displays the status of the device as an icon.

### ■ Status indication icons for the power, network connection, and shutter/AV mute





	Device power is ON.
	Device power is OFF (in standby status).
	Device power is OFF and cooling down.
	Device power is ON and warming up.
	Device has been disconnected from the network.
	The device connected to the network has the same IP address but different from the time of registration. The device needs to be updated. Execute the device registration information update. (page 68)
	Shutter is open/device is in the audio and visual mute OFF status.
	Shutter is closed/device is in the audio and visual mute ON status.
	Shutter is open/device is in the audio mute ON status.
	Shutter is closed/device is in the visual mute ON status.

### ■ Warning indication icons

	Lamp replacement time is near. Please obtain a new lamp unit.
	Intake temperature or exhaust temperature is high. Optics module temperature is high or low. Check the ventilation and exhaust temperatures to ensure that the device is used within the operating temperature.
	Filter clogged warning, low remaining ARF/ACF. Please obtain a new ARF/ACF unit. Perform maintenance of the filter except for ARF/ACF.
	All other warnings Consult your retailer.

## About the Brief Information Display

### ■ Error indication icons

	Lamp replacement is overdue, lamp illumination failed, lamp is not installed, or lamp is malfunctioning. Please exchange lamp if the replacement time is overdue. For other instances, consult your retailer.
	Intake temperature, exhaust temperature or optics module temperature is high. Optics module temperature is low for a certain time duration. Check the ventilation and exhaust temperatures to ensure that the device is used within the operating temperature.
	Filter clogged error, ACR/ARF/ACF/air filter unit not installed, filter winding failed, or there is no remaining ARF/ACF. If the remaining ARF/ACF is low, please replace the ARF/ACF unit. Perform maintenance or replacement of the filter except for ARF/ACF. Remove any foreign matter that is present. For other instances, consult your retailer.
	All other errors (Lamp unit cover remaining open, fan error, shutter error, aperture error, color wheel error, ACR/ARF/ACF not installed, filter cleaning process time-out, DC voltage error, lens shift error, internal clock battery replacement is required, etc.) Consult your retailer.





### ■ Notification indication icons

	Displayed by the early warning function when there is a notification message. Check the detailed information.
---	--

### Notes

- When both a warning and an error are generated simultaneously, an error icon will be displayed. Refer to operating manual for the relevant device for how to respond to warnings and errors.
- Depending on the flat panel display model, when a warning or error has occurred, or a new warning or error occurs, icons that indicate the warning or error may not appear under [Status] in the brief information display pane. For details on the models for which this limitation applies, refer to the “List of Compatible Device Models” of this application software which is posted on the following website.  
<https://panasonic.net/cns/prodisplays/download/software/>  
You can view information on all device warnings or errors that have occurred under the [Self Test] item in the [Details] tab of the [Device Property] window. (page 89)

### ■ Status icons for devices monitored for early warning

	Device is in a normal status.
	Warning information has been detected by the early warning function.
	Error information has been detected by the early warning function.
	Notification information has been detected by the early warning function.



## About the Brief Information Display

### ■ Other brief information

You can change the items to display from [Monitor Information] (page 234) from the setting window of option.

**[Camera]:** When you link a network camera with a device (page 56), an icon will be displayed.

	When you click the icon, the network camera's video will be displayed as an image. (page 91) <ul style="list-style-type: none"> <li>When you click the [Camera View] tab, you can display the network camera's video as an image all at once. (page 92)</li> </ul>
---	The network camera is not linked to a device.





**[Remote Preview]:** An icon will be displayed when a device supports the remote preview function or remote preview lite function.

	When you click the icon, the video input into the device will be displayed as an image. (page 93) <ul style="list-style-type: none"> <li>When you click the [Remote Preview] tab, you can display the video input into the device as an image all at once. (page 94)</li> </ul>
---	The device does not support the remote preview function or remote preview lite function.

**[ECO setup level]:** The icon is displayed when the device supports the ECO management function (page 170).

	Green area increases when ECO setting items increase in the ECO management setting of the device.
----	The device does not support the ECO management function.

**[Image distribution]:** The execution status of devices set to [Simultaneous image distribution] (page 130) or [Distribution image deletion] (page 130) is displayed as an icon.

	State where image has not been delivered yet, delivered image was just deleted, or this software has just started.
	Currently delivering an image.
	Image has been delivered.
	Image has been delivered and the image is displayed.
	Image is being delivered, or an error occurred while deleting a delivered image. Check the following points. <ul style="list-style-type: none"> <li>Is the device's LAN connection normal?</li> <li>Is the device connected with the wireless manager?</li> <li>Is the network password set to the device?</li> </ul>
----	The device does not support the image delivery function and delivered image deletion function.

## About the Brief Information Display

---

<b>[Signage information]:</b>	Displays the signage playback status of devices equipped with Content Manager. When content is played back using the USB media player function of the flat panel display, the content name being played back is displayed.
<b>[IP Address]:</b>	Displays the device's IP address.
<b>[Lamp/Light device Runtime]:</b>	Displays the runtime for the lamp or light device with the longest runtime. (The time of the installed lamp/light source number is indicated as a tooltip.)
<b>[Closed Caption]:</b>	Displays closed caption mode.
<b>[Input]:</b>	Displays the selected input terminal information of the device.
<b>[Source Signal]:</b>	Displays the current signal name of the device.
<b>[Model Name]:</b>	Displays the device model name.
<b>[Wireless Settings]:</b>	Displays the WIRELESS LAN connection method (SIMPLE, S-DIRECT, M-DIRECT, etc.) configured in the projector's menu.
<b>[Intake Air Temperature]:</b>	Displays the intake air temperature information of the projector.
<b>[Optics Module Temperature]:</b>	Displays the optics module temperature information of the projector.
<b>[Around Air Temperature]:</b>	Displays the around air temperature information of the projector.
<b>[OSD Setting]:</b>	Displays the OSD setting information of the projector.
<b>[AC Voltage]:</b>	Displays the AC voltage information of the projector.
<b>[Serial Number]:</b>	Displays the device serial number.
<b>[Geometry]:</b>	Displays the setting information of the projector's geometry correction.
<b>[Board Temperature (FP)]:</b>	Displays the board temperature information of the flat panel display.
<b>[Exhaust Temperature (FP)]:</b>	Displays the exhaust temperature information of the flat panel display.
<b>[Intake Temperature (FP)]:</b>	Displays the intake air temperature information of the flat panel display.
<b>[Panel Temperature (FP)]:</b>	Displays the panel temperature information of the flat panel display.

### Notes

- When "▲" is displayed when an item of the list is selected, you can display it by descending order or ascending order.
- Depending on the model, some information may not be obtained from the devices. Information that cannot be obtained is displayed as "---".
- When using a projector whose lamp output can be set to Hi/Low (or normal/eco), the runtime when the lamp is set to Low is converted to an equivalent runtime when the lamp is set to High, and the corresponding total runtime is displayed.

## About the Brief Information Display

# Update device information

### ■ Updating automatically

The information in the <Device Monitoring> window is updated automatically according to the settings configured in “Setting the Information Updating Interval” (page 229).

### ■ Updating manually

#### 1 Select [Device Management] → [Update Information] from the menu.

- Alternatively, you can use the following method.
  - Press the [F5] button on the keyboard.

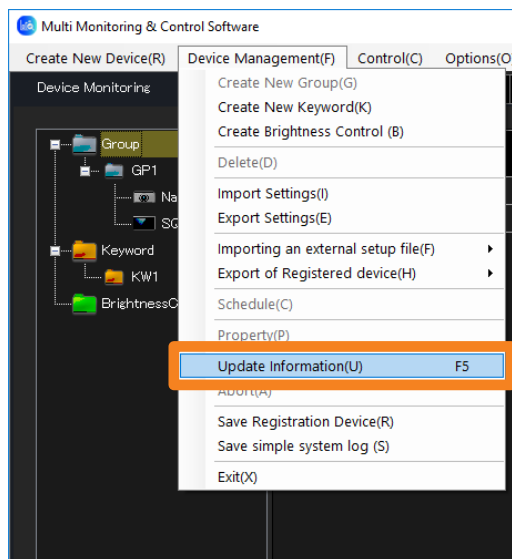

Information update is complete when the indication in the status bar of the <Device Monitoring> window (page 37) returns to [Ready], after it changes from [Ready] to [Updating Device Information.] and a progress bar appears on the right side.

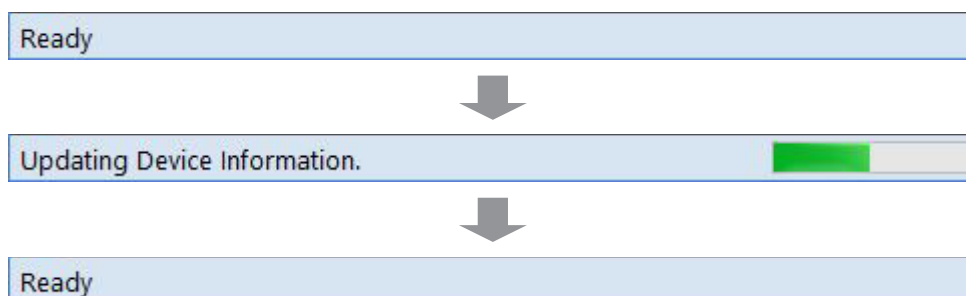

## About the Brief Information Display

If the number of registered devices increases, then updating the information will take longer. If you wish to abort the update before completion, select [Device Management] → [Abort] from the menu.

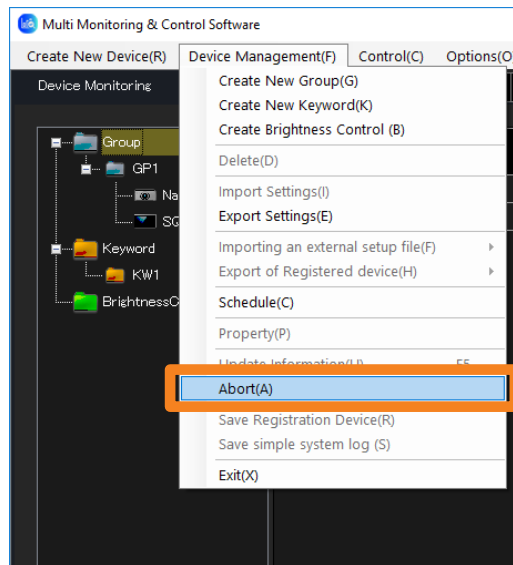

The operation above changes the status bar on the <Device Monitoring> window (page 37) from [Updating Device Information.] to [Canceling...]. When the abort process is complete, the message on the status bar indicates [Ready].

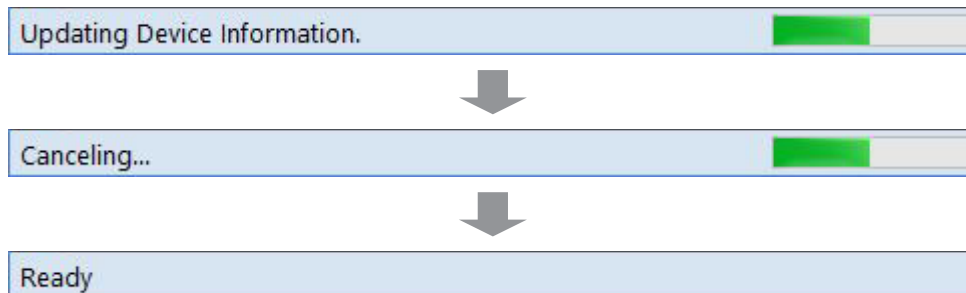

## About the Brief Information Display

## Update firmware of multiple devices simultaneously

Simultaneous multiple device updates can be done onto the firmware of a registered device.

### Notes

- Currently (As of May 2024), only projectors are supported.
- To see if a device being used supports simultaneous multiple device firmware updates, refer to the “List of Compatible Device Models” of this application software which is posted on the following website.  
<https://panasonic.net/cns/projector/download/application/>
- When updating firmware, download the firmware update tool (Compressed file in zip format) compatible to the device you want to update from the following website.  
 When you extract the compressed file that you have downloaded, an exe format execution file is generated.  
<https://panasonic.net/cns/projector/pass/>

- 1 From the tree pane on the <Device Monitoring> window, select a device or group then right-click it, and select [Firmware update].

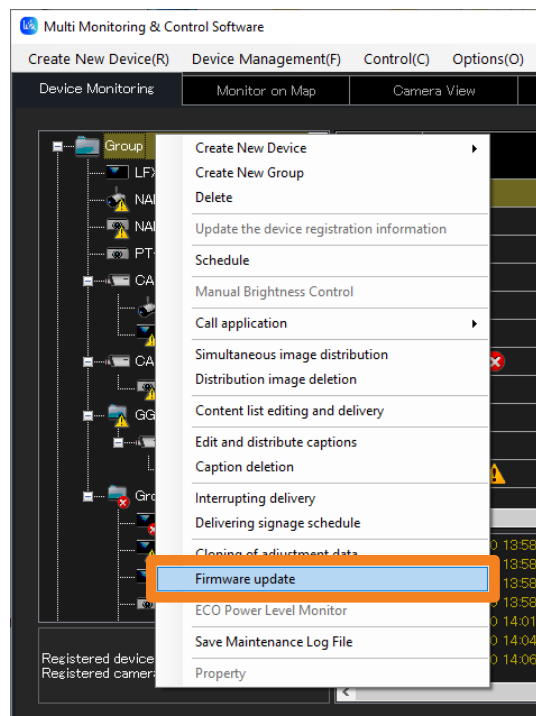

## About the Brief Information Display

### 2 When the confirmation message is displayed, click [Yes].

- The firmware update is cancelled when [No] is selected.

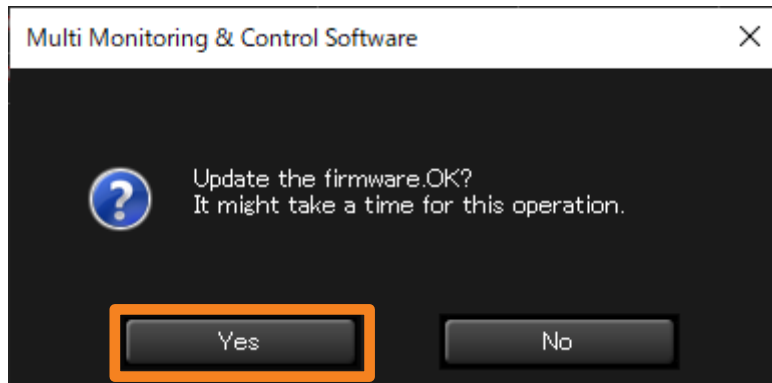

### 3 When the device list is displayed, click the [Select] of the model you want to update.

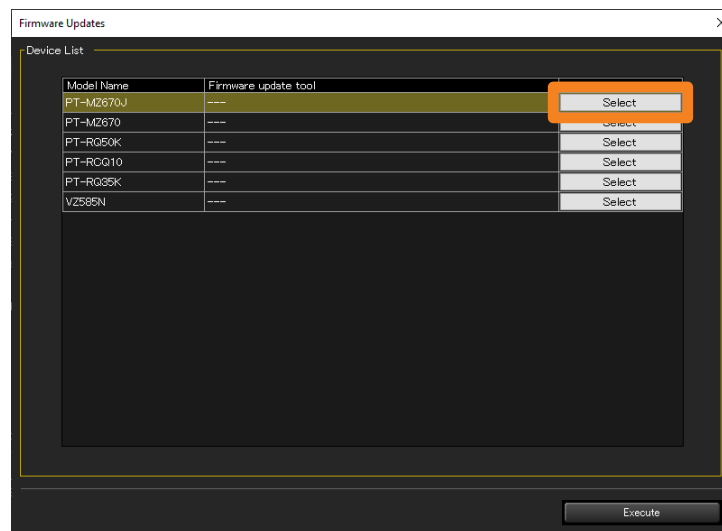

### 4 Select the corresponding firmware update tool (exe format execution file), and click [Open].

File name: FirmUpdateTool\_Model name\_Firmware version.exe

Example) For a PT-RZ17K model

FirmUpdateTool\_RZ24K\_102.exe

(An update tool for PT-RZ24K/PT-RZ17K/PT-RZ14K version 1.02)

## About the Brief Information Display

## 5 Click [Execute].

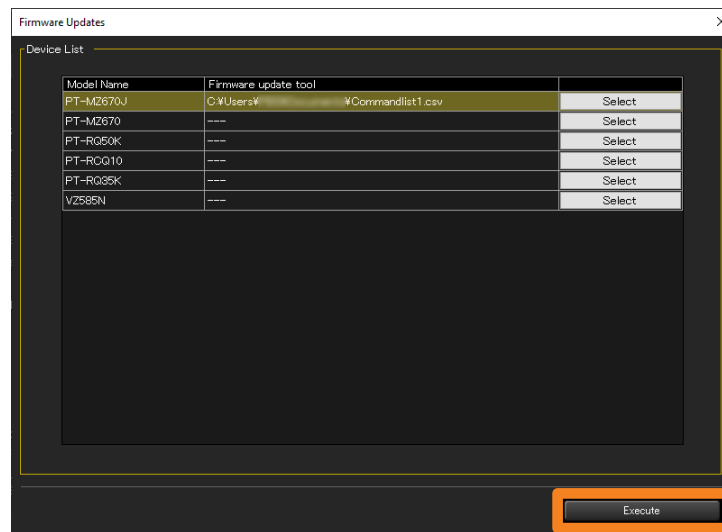

- The firmware update result will be displayed in the command execution log pane of the <Device Monitoring> window.



Device update is complete when the indication in the status bar of the <Device Monitoring> window (page 37) returns to [Ready], after it changes from [Ready] to [Updating the firmware.] and a progress bar appears on the right side.

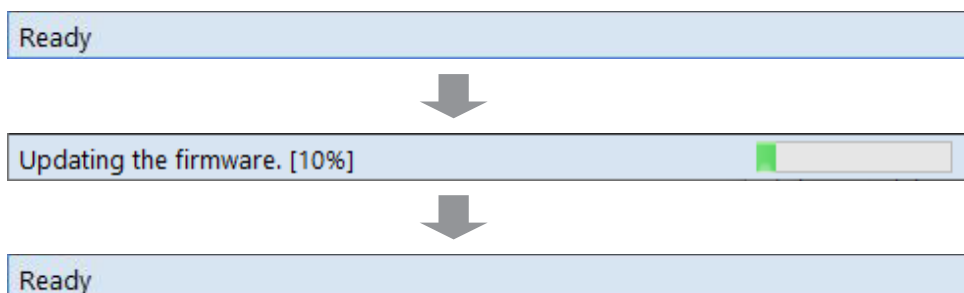

## About the Brief Information Display

---

### Notes

- After starting the firmware update, information update is stopped until the firmware update is complete.
- Simultaneous multiple device updates are executed onto target devices in increments of a 100 devices. When the device you want to update exceeds a 100 devices, the update process is divided into multiple times for every 100 devices.
- If the firmware of the device is already the latest version, the update process of the corresponding device is not executed and the next device's update process will proceed.
- If a firmware update tool that differs from the device you want to update is selected, the update process will not be executed.
- When a model that does not support simultaneous multiple updates or a different firmware update tool is selected, the corresponding model's update process is not executed and the next model's update process will proceed. If there is an unprocessed model, a [Failed to update the firmware.] message is displayed after all processes are completed. Check the device where [UPDATE NG] is displayed in the command execution log pane.



## Detailed Information Display

**1** From the tree pane on the <Device Monitoring> window, select the device whose detailed information you want to view, right-click it, and select [Property].

- Alternatively, you can use the following method.
  - Select [Device management] → [Property] from the menu.
  - Select the device in the Brief information display pane, right-click it, and select [Property] in the displayed menu.

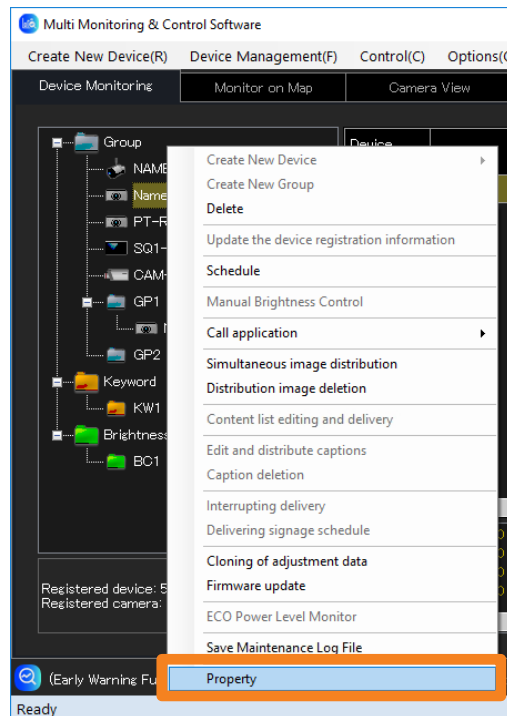

**2** Open the [Details] tab to view the detailed information.

- Click [Close] to complete the Detailed Information Display.

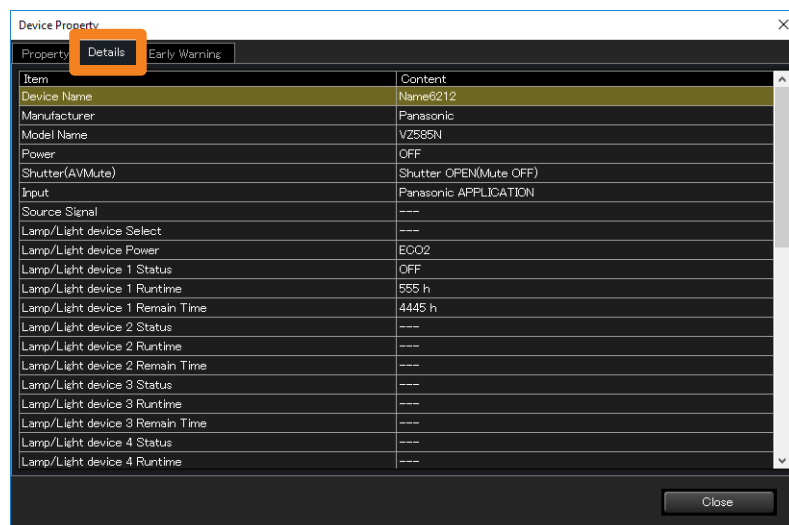

## Detailed Information Display

## Displayed items

The detailed information display shows the information listed in the table below.

Item	Description
Device Name	Device name
Manufacturer	Manufacturer's name
Model Name	Model name
Power	Power supply status
Shutter (AVMute)	shutter control/AV mute
Input	Input terminal
Source Signal	Input signal
Lamp/Light device Power	Lamp/Light device output (LIGHT Power / Operating Mode)
Lamp/Light device Power	Lamp/Light device output
Lamp/Light device 1 Status	Lamp/Light device 1 status
Lamp/Light device 1 Runtime	Lamp/Light device 1 operating time
Lamp/Light device 1 Remain Time	Lamp/Light device 1 remaining time
Lamp/Light device 2 Status	Lamp/Light device 2 status
Lamp/Light device 2 Runtime	Lamp/Light device 2 operating time
Lamp/Light device 2 Remain Time	Lamp/Light device 2 remaining time
Lamp/Light device 3 Status	Lamp/Light device 3 status
Lamp/Light device 3 Runtime	Lamp/Light device 3 operating time
Lamp/Light device 3 Remain Time	Lamp/Light device 3 remaining time
Lamp/Light device 4 Status	Lamp/Light device 4 status
Lamp/Light device 4 Runtime	Lamp/Light device 4 operating time
Lamp/Light device 4 Remain Time	Lamp/Light device 4 remaining time
Intake Air Temperature	Intake air temperature
Around Lamp/Light device Temperature	Around lamp/light device temperature (exhaust temperature)

Item	Description
Optics Module Temperature	Optics module temperature
Device Runtime	Device operating time
Main Version	Main microcomputer Software version
Sub Version	Sub microcomputer Software version
Network Version	Network microcomputer Software version
Serial Number	Serial number
Self Test	Self-diagnosis results
Fan Status (FP)	FAN rotation status
H Clock	Horizontal frequency of input signal
V Clock	Vertical frequency of input signal
Power Save Setting (FP)	Power consumption reduction setting
Board Temperature (FP)	Board temperature
Exhaust Temperature (FP)	Exhaust temperature
Intake Air Temperature (FP)	Intake air temperature
Panel Temperature (FP)	Panel temperature
Light Device 1 Runtime	Light device 1 operating time
Light Device 2 Runtime	Light device 2 operating time
Light device Temperature 1	Light device temperature 1
Light device Temperature 2	Light device temperature 2
USB Memory Capacity	USB memory capacity
AC Voltage	AC voltage
Geometry	Geometry correction settings

## Notes

- Items indicated in the Detailed information display can be changed in the [Detailed Information] on the <Setting> window (page 234).
- If the content of a detailed information display item does not fit into its respective display area, you can display the content in its entirety as a tooltip by placing the mouse pointer on the [Item].
- In the Detailed information display, if a lamp life warning is detected, the remaining lamp time will turn yellow in the row for the problematic lamp. If a lamp life error is detected, it will turn red.
- Depending on the connected device, there may be some items that cannot be displayed. In this case, "---" is displayed.
- When using a projector whose lamp output can be set to Hi/Low (or normal/eco), the runtime when the lamp is set to Low is converted to an equivalent runtime when the lamp is set to High, and the corresponding total runtime is displayed.

## Display network camera video

You can display the video of a registered network camera as an image.

### Notes

- For details on registering a network camera, see the following pages.
  - Register a network camera (page 54)
  - Linking a network camera and device (page 56)

### ■ Selecting a linked device and displaying it

#### Preparation:

- Display the [Camera] item in the brief information display. (page 234)

**1** Select  (Network camera) or an icon of a device linked to a network camera or group from the <Device Monitoring> window.

**2** Click  on the brief information display.

A network camera image will be displayed.

- If the network camera and device is not linked, it will be displayed as “ -- “.
- If an image was not able to be retrieved, a [Not able to get image from the device.] message will be displayed.

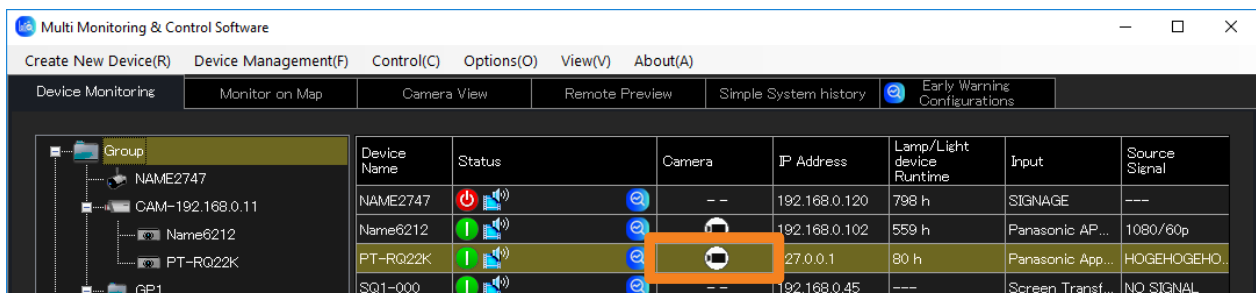

## Display network camera video

### ■ Display all at once

#### 1 Click the [Camera View] tab in the <Device Monitoring> window.

- The camera monitoring window will be displayed.

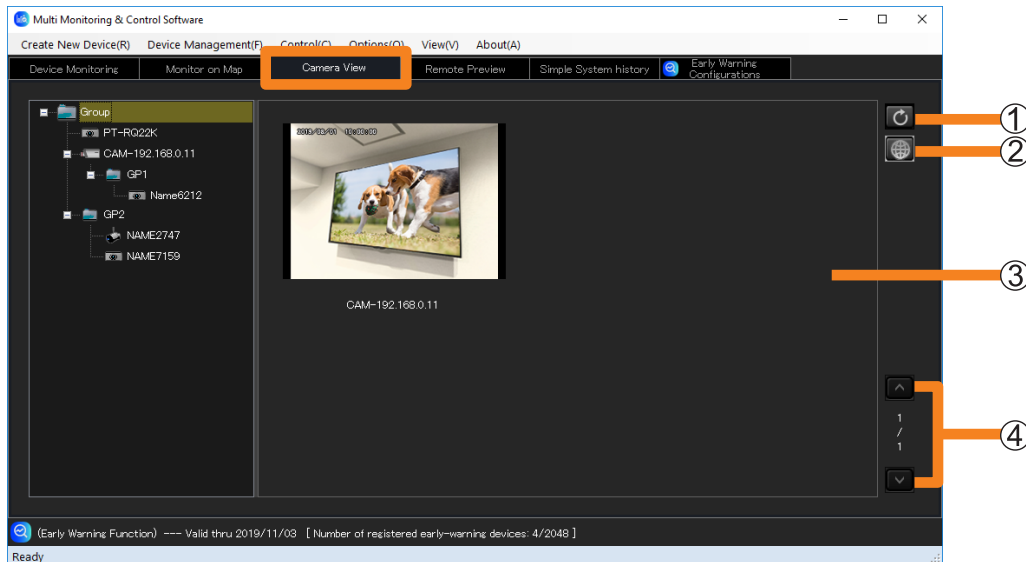

#### ① Update button

The image display area will be updated to the latest state.  
(Automatic update interval: 5 seconds)

#### ② Camera setting button

You can display the setting window of the network camera.

- It may be required to install the necessary plug-in software to display the setting window of the network camera depending on your environment. Follow the on-screen instructions and install the plug-in software.
- If you cannot install the plug-in software, use the Web browser of the computer being used, and display the setting window of the network camera.

#### ③ Image display area

All registered network camera images will be displayed.

- The device image selected from the tree pane will be indicated by a yellow box.
- If a problem has occurred, a [Not able to get image from the device.] message and the icons below will be displayed.

- (Error): The camera is not connected to the network.
- (Warning): It is connected to the network, but the image was not able to be retrieved.

#### ④ Page switching button/Page number

If the images in the display area do not fit in 1 page, click and move the page.

## Display the image input into the device

Displays the video input into the device that supports the remote preview function or remote preview lite function as an image.

### Notes

- To see if the device you are using supports the remote preview function or remote preview lite function, refer to the “List of Compatible Device Models” of this application software which is posted on the following websites.  
<https://panasonic.net/cns/projector/download/application/>  
<https://panasonic.net/cns/prodisplays/download/software/>

### ■ Select a device and display it

#### Preparation:

- Display the [Remote Preview] item in the brief information display. (page 234)

#### 1 Select a device icon that supports the remote preview function or remote preview lite function from the tree pane of the <Device Monitoring> window.

#### 2 Click on the brief information display.

The video input into the device will be shown as an image.

- “--” is displayed for devices that do not support the remote preview function or remote preview lite function.
- If an image was not able to be retrieved, a [Not able to get image from the device.] message will be displayed.

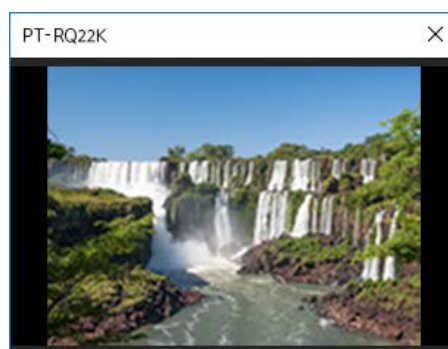
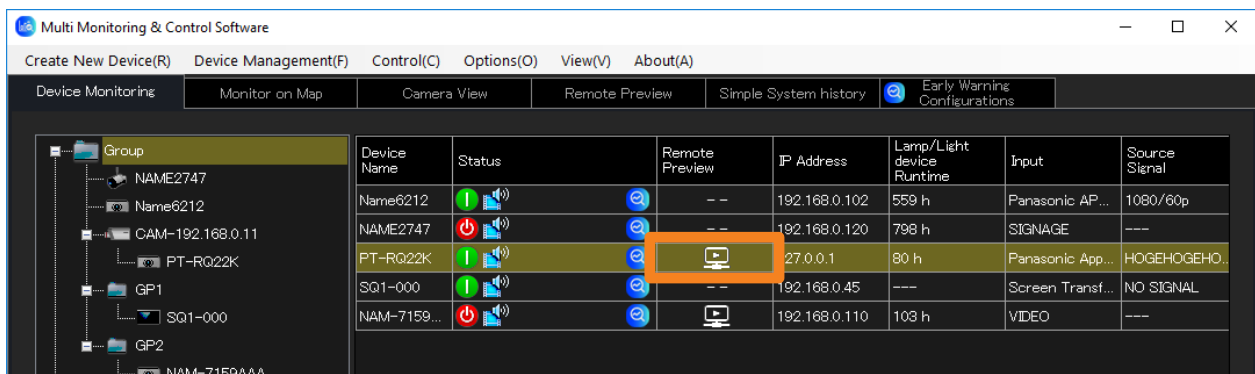

## Display the image input into the device

### ■ Display all at once

#### 1 Click the [Remote Preview] tab in the <Device Monitoring> window.

- The remote preview window will be displayed.

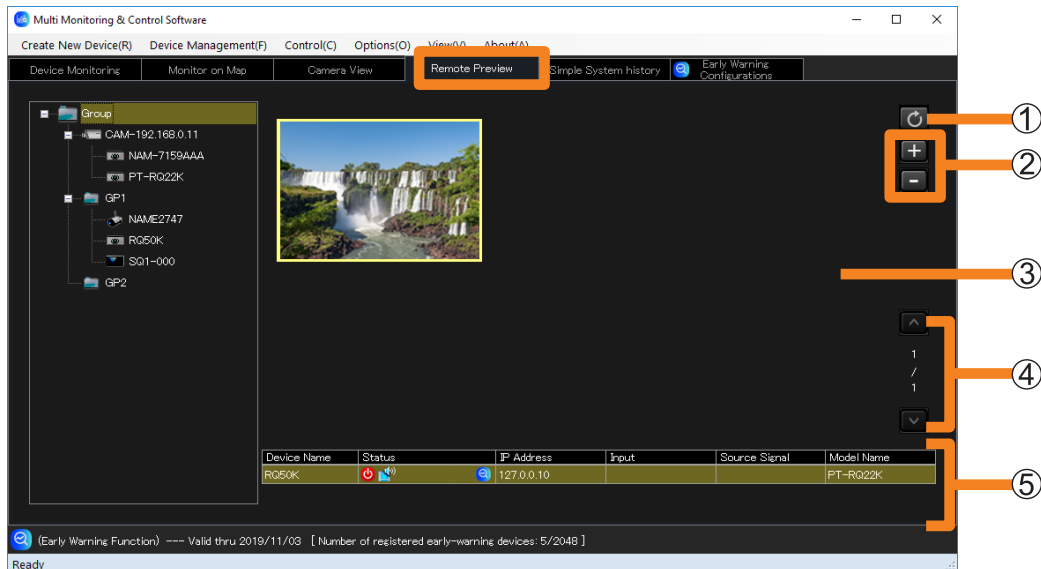

#### ① Update button

The image display area will be updated to the latest state.

- The image may not be updated depending on the device operating status. Wait for a while (about 5 seconds), and click the update button again.

#### ② Enlarge/Reduce button

Enlarge or reduce the size of the selected image (yellow box) in 5 levels.

- You can switch the image size width in 5 levels from 200 x 150 to 400 x 300.
- You can also change it by scrolling with your mouse.

#### ③ Image display area

The video input into the device will be shown as an image.

- The device image selected from the tree pane will be indicated by a yellow box.
- If you drag the selected thumbnail, you can move (Change the layout) thumbnail within the image display area.
- In addition to images, the following messages may be displayed.
  - [Not able to get image from the device.]: When the image cannot be retrieved.
  - [Preview aspect ratio is different from the projected image.]: When settings, such as display mode, have been changed on the device.
  - [Displaying test pattern]: When the test pattern is displayed on the device.
  - [It is starting up.]: When the device is powered on, and starting up.
  - [No signal is input.]: When no signal is input to the device.
  - [Can not be displayed due to copyright protection.]: When a video protected by digital rights management is input on the device.
  - [Images can not be displayed because the device settings are HTTPS settings.]: When the HTTPS setting is enabled on the device.

#### ④ Page switching button/Page number

If the images in the display area do not fit in 1 page, click and move the page.

#### ⑤ Device information display area

The device status and video input information will be displayed.

### Display the image input into the device

---

#### Notes

- The update interval of the actual on-screen display is heavily affected by the network environment, the computer's capabilities, and the number of devices registered etc.
- If there is a "COMMAND PROTECT" on the menu of the device, enable that setting then use it. When the setting is disabled, images may not display on the image display area of the remote preview window.

For details on the "COMMAND PROTECT" menu, refer to the instruction manual of the device you are using.

## Displaying the Simple System History Information

### 1 Click the [Simple System history] tab.

You can display the system history information in a table format.

- The information displayed is the system history for the number of items that correspond to [System log entry save count] in the [Options] → [Settings] → [General] tab of the menu. (page 230)

Checked Time	Group	Device Name	IP Address	Model Name	Serial Number	Status	Details
2019/08/21 9:21:31	GP1	Name6212	192.168.0.102	V2585N	----	⚠	Warning : Can't communicate
2019/08/21 9:21:31	GP2	NAME2747	192.168.0.120	JX200HWJ	----	⚠	Warning : Can't communicate
2019/08/21 9:21:31	GP2	NAME7159	192.168.0.110	PT-M2670J	----	⚠	Warning : Can't communicate
2019/08/21 9:21:31	GP1	SQ1-000	192.168.0.45	55SQ1J	----	⚠	Warning : Can't communicate
2019/08/21 9:21:22	Group	PT-R022K	127.0.0.1	PT-R022K	----	⚠	Warning : Can't communicate

### Simple system history information display area

Displays the following fields from the detected system history information.

<b>[Checked Time]*</b>	Displays the date and time when the warning and error were detected.
<b>[Group]*</b>	Displays the group name which target device belongs. (If the group folder of the tree pane is  , the camera name set at the time of network camera registration or CAM-XXX (XXX: network camera's IP address) will be displayed as the group name.)
<b>[Device Name]*</b>	Displays the target device name (or host name).
<b>[IP Address]*</b>	Displays the device's IP address.
<b>[Model Name]*</b>	Displays the device model name.
<b>[Serial Number]*</b>	Displays the serial number of a device.
<b>[Status]</b>	Displays the status that occurred on the device as an icon. For detailed information on the icons, see the Brief information display (page 77).
<b>[Details]</b>	Displays the contents of the notification.

\* : You can display it by descending order or ascending order.



## Displaying the Simple System History Information

### Notes

- You can view information on the device warnings or errors that have occurred under the [Self Test] item in the [Details] tab of the [Device Property] window. (page 89)
- The warning information and error information are not displayed on [Self Test] even when warning or error icon is displayed on [Status] of the simple system history screen of the flat panel display. Confirm the device history information of the early warning function (page 196), or check with the device.
- Depending on the flat panel display, the warning or error icon may not be displayed on [Status] of the simple system history screen even when a warning or error occurs.
- When multiple error warnings occur at the same time, the same icon may appear more than once in [Status].
- If you want to check the details of the system history information, check [History (All Device)] in the early warning function (page 196), or select [Device Management] → [Save simple system log] and check the output file that is saved (page 97).

## Saving the Simple System History Information

Perform the following procedure to output the simple system history information to a file.

- 1 Select [Device Management] → [Save simple system log] from the menu.**

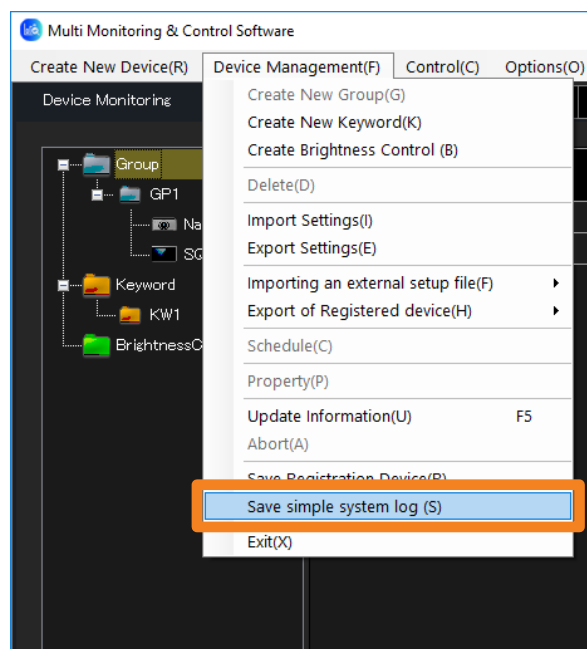

- 2 Set the save destination and file name, and click [Save].**

The simplified system history is saved as csv format. You can see the information with Text Editor and Microsoft Excel.

## Displaying the Simple System History Information

### ■ Example showing saved data

The simple system history file describes as following.

	A	B	C	D	E	F	G	H	I	J	
①	1	Multi Monitoring & Control Software									
②	2	Version	V3.0.14								
③	3	Time	2019/9/25 14:32								
④	5	Device Name	Manufacturer	Model Name	IP Address	Serial Number	Checked Time	Error Status	Self Diagnosis	Detail Information	Self Test
	6	NAME4636	---	PT-RQ50KD	*****	---	****/**/** 17:33:48	1 ---	---	Warning : Can't communicate	---
	7	49XF1HJ	Panasonic	49XF1HJ	*****	012345ABC	****/**/** 9:34:30	1 OK	---	Warning : Can't communicate	0
	8	NAME4636	---	PT-RQ50KD	*****	---	****/**/** 9:34:39	1 ---	---	Warning : Can't communicate	---
	9	49XF1HJ	Panasonic	49XF1HJ	*****	012345ABC	****/**/** 11:22:00	1 OK	---	Warning : Can't communicate	0
	10	NAME4636	---	PT-RQ50KD	*****	---	****/**/** 11:22:09	1 ---	---	Warning : Can't communicate	---
	11	49XF1HJ	Panasonic	49XF1HJ	*****	012345ABC	****/**/** 9:43:51	1 OK	---	Warning : Can't communicate	0
	12	NAME4636	---	PT-RQ50KD	*****	---	****/**/** 17:33:48	1 ---	---	Warning : Can't communicate	---
	13	49XF1HJ	Panasonic	49XF1HJ	*****	012345ABC	****/**/** 9:34:30	1 OK	---	Warning : Can't communicate	0
	14	NAME4636	---	PT-RQ50KD	*****	---	****/**/** 9:34:39	1 ---	---	Warning : Can't communicate	---
	15	49XF1HJ	Panasonic	49XF1HJ	*****	012345ABC	****/**/** 11:22:00	1 OK	---	Warning : Can't communicate	0
	16	NAME4636	---	PT-RQ50KD	*****	---	****/**/** 11:22:09	1 ---	---	Warning : Can't communicate	---
	17	49XF1HJ	Panasonic	49XF1HJ	*****	012345ABC	****/**/** 9:43:51	1 OK	---	Warning : Can't communicate	0
	18	NAME4636	---	PT-RQ50KD	*****	---	****/**/** 9:44:00	1 ---	---	Warning : Can't communicate	---
	19	Name6212	Panasonic	VZ585N	*****	VZ585N-No	****/**/** 11:24:01	3 OK	---	Notice : Video stopping	0
	20	Name6212	Panasonic	VZ585N	*****	VZ585N-No	****/**/** 12:14:02	3 OK	---	Notice : Video stopping	0
⑤	21	[EOF]									

① Software name

② Version

③ File save date and time

④ Description items:

- Device name
- Manufacturer's name
- Model name
- IP Address
- Serial number
- Date and Time when error generation was detected
- Error status (6 digits)
- Contents of error
- Detailed error information
- Self-diagnosis information (16, 32 or 64 digits: depending on model)

⑤ File end indication

## Displaying the ECO Power Level Monitor

This function displays the ECO power consumption level and the runtime of the projector on a daily basis.

The past 30 days' worth of ECO power level monitor information starting back from the most recent day is stored internally on the projector and can be checked by the ECO power level monitor display function.

### Notes

- For projectors that support the ECO power level monitor display function. To see if the projector being used is supported, refer to the “List of Compatible Device Models” of this application software which is posted on the following website.  
<https://panasonic.net/cns/projector/download/application/>

**1 From the tree pane on the <Device Monitoring> window, select the projector you want to assign a ECO power level monitor to, right-click it, and select [ECO Power Level Monitor].**

- When a projector that does not support the ECO power level monitor display function is selected in the tree pane of the <Device Monitoring> window, [ECO Power Level Monitor] cannot be selected.
- To use this function, the date/time of the computer where this software is installed must be synchronized with the date/time of the projector.

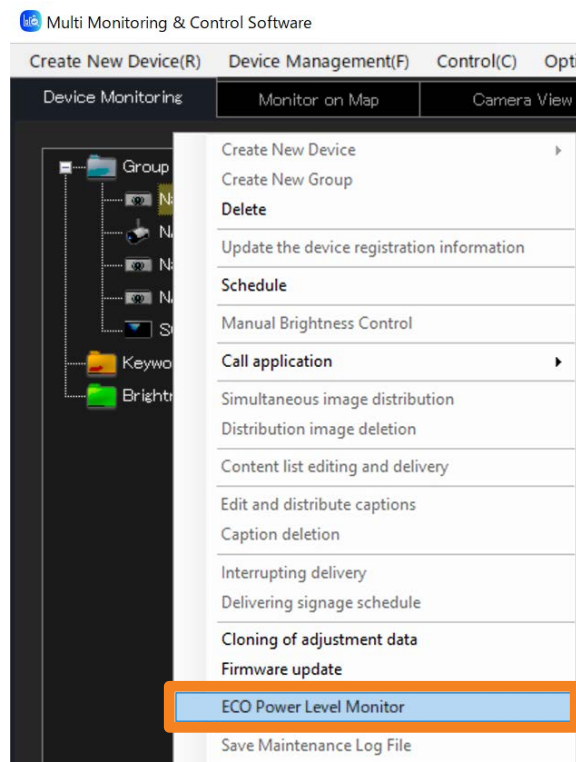

## Displaying the ECO Power Level Monitor

### 2 When acquisition of the log is completed, the ECO power level monitor is displayed.

#### [ECO Power Level]

By clicking it, the ECO power level for each day of projector use is displayed.

#### [Runtime]

By clicking it, the runtime for each day of projector use is displayed.

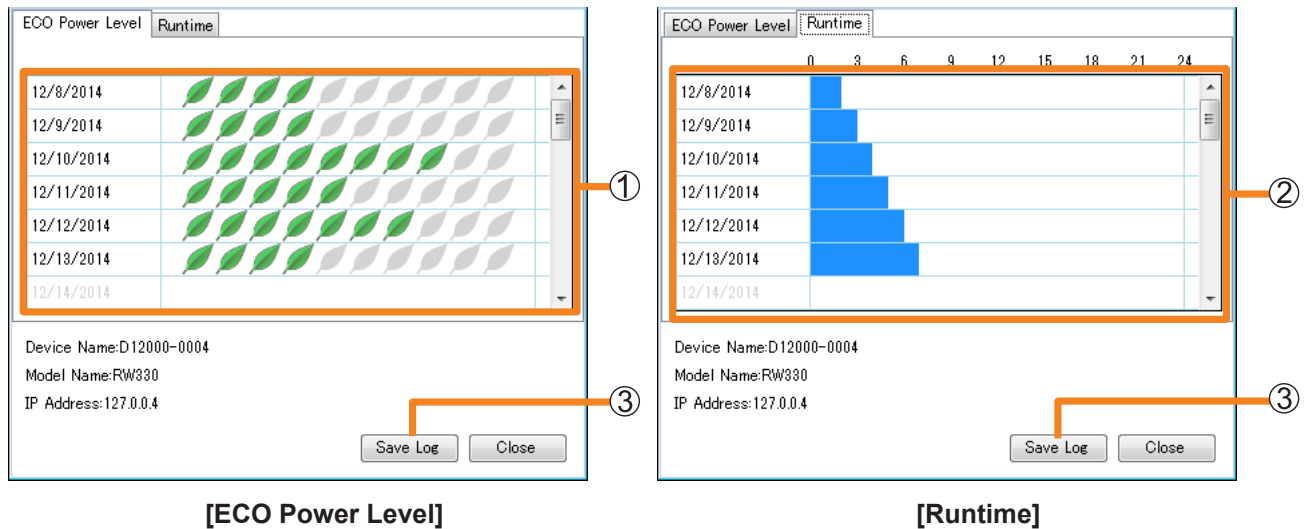

① “ECO Power Level” graph	<p>The more green Leaf marks (🌿) are displayed, this indicates that a higher ECO power level has been attained and that the projector has been run with less power consumed.</p> <p>If information for a particular day could not be normally acquired, then the Leaf mark is displayed by a broken line.</p> <p>The graph is not displayed for days when the projector is not used.</p>
② “Runtime” graph	<p>This displays the runtime of the projector.</p> <p>The graph is not displayed for days when the projector is not used.</p>

- To reduce the power consumed by this projector, the ECO management function on the projector must be set. Change the settings in [MAIN MENU] → [PROJECTOR SETUP] → [ECO MANAGEMENT] → [LIGHT POWER] and [AUTO POWER SAVE] in the on-screen menu of each projector.  
For details, refer to the instruction manual for each projector.
- Graphs displayed by the ECO power level monitor show data collected every day. The ECO management settings of a projector sometimes are not reflected immediately in the graph.

### 3 By clicking [Save Log] (③) on the [ECO Power Level] or [Runtime] tab, you can save the data of the ECO power level monitor.

Select the location to save the file, enter a file name of your choice, and click [Save], then you can save it in a CSV format.

### 4 Click [Close] to close the window.

## Displaying the ECO Power Level Monitor

### ■ Example showing saved data

Data is saved as follows:

```

① Multi Monitoring & Control Software,,
② Version,V *.*(**) ,
③ Time,****/**/ 17:28,
④ Device Name,Projector3,
⑤ Model Name,RW330,
⑥ IP Address,127.0.0.8,
⑦ Checked Date,ECO Level (0-10),Device Running Time(min)
****/**/,5,60
****/**/,4,60
****/**/,4,60
****/**/,8,60
****/**/,5,60
****/**/,7,60
****/**/,4,420
⑧ [EOF],,

```

① Software name

② Version

③ File save date and time

④ Device name

⑤ Model name

⑥ IP address

⑦ Description Items: Data save date  
ECO power level (0 to 10)  
Device runtime (mins)

⑧ End-of-file display

## Saving a Maintenance Log

You can save the log information containing the operating status of the device being monitored or controlled by this software in the form of files.

When a problem occurs, you can give these log files to the serviceman who can use them as analysis information.

### Notes

- For projectors that support the saving a maintenance log display function. To see if the projector being used is supported, refer to the “List of Compatible Device Models” of this application software which is posted on the following website.  
<https://panasonic.net/cns/projector/download/application/>

**1** From the tree pane on the <Device Monitoring> window, select the device or group folder whose log you want to save, right-click it, and select [Save Maintenance Log File].

- To save a batch log for all target projectors, select the parent group ([Group] folder), right-click, and select [Save Maintenance Log File].

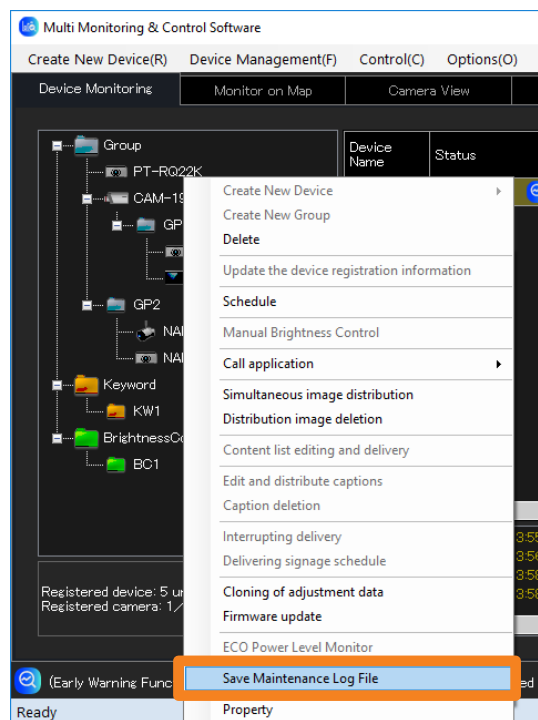

## Saving a Maintenance Log

**2 A confirmation message will be displayed. Perform the operation in accordance with the information in the message.**

When you click [Yes], maintenance log retrieval begins.  
To cancel retrieval of the maintenance log, click [No].

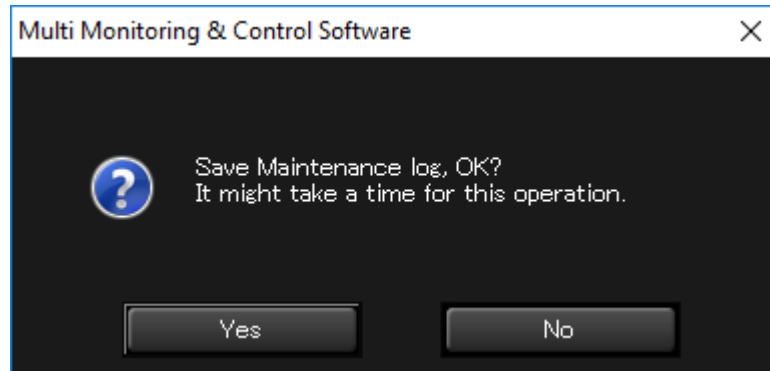
**3 Select a folder in which to save the maintenance log and click [OK].**

The acquisition of the maintenance log (system log/lamp log/brightness sensor log) of the monitored or controlled device commences.  
To save to a new folder, click [Make New Folder] to create a new folder.

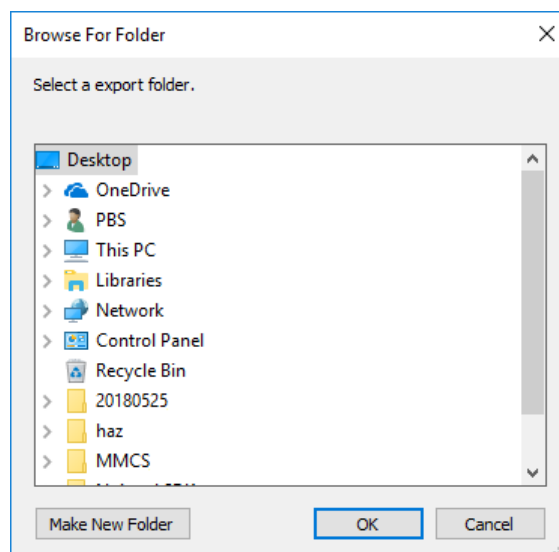

Depending on the device, the maintenance log is saved in one of the following file formats.

Save method	Log Type	File name
Save logs individually	System log	Model Name_Serial No_System_log (without extension)
	Lamp log	Model Name_Serial No_Lamp_log (without extension)
	Brightness sensor log	Model Name_Serial No_BrightSensor_log (without extension)
Save logs all at once*1	Batch log	Date and Time_Device Name_Model Name_Serial No. (extension: .log/.bin)

\*1 Batch logs contain all the information contained in system logs, lamp logs, and brightness sensor logs.

## Saving a Maintenance Log

---

**4** When the confirmation message is displayed, click [OK].

### Notes

- Maintenance logs are saved in binary format.
- Maintenance log information can be checked by service personnel only.
- Maintenance logs are recorded only on devices that support them.



## Saving the Information of a Registered Device

You can export all information of a registered device to a CSV file. To export device information, follow the following steps.

- 1 Select [Device Management] → [Save Registration Device] from the menu.**

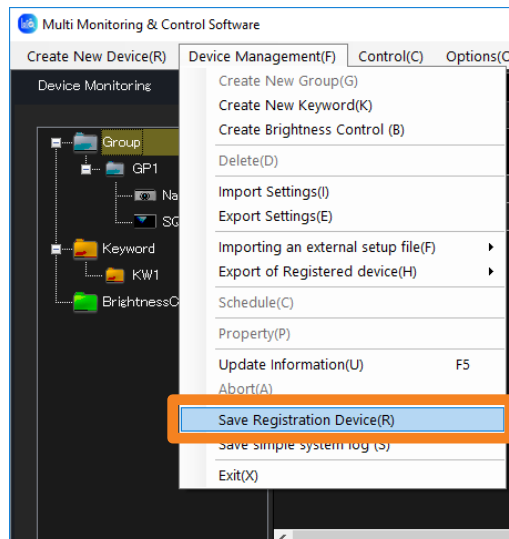

- 2 Set the save destination and file name, and click [Save].**

The registered device information is saved in an auto-generated file name that indicates the year, month, day, hour, minute, and second when the file was saved. You can change the file name by entering the desired file name.

- The registered device information will be saved in CSV format. You can see the information with Text Editor and Microsoft Excel.

- 3 When the “saved successfully” message appears, click [OK].**

## Saving the Information of a Registered Device

### ■ Example showing saved data

The following descriptions are saved in the registered device information file.

	A	B	C	D	E	F		
①	1	Multi Monitoring & Control Software						
②	2	Version	V***					
③	3	Date	*****/**/*	15.42.29				
④	5	Device Name	Group	Status	Camera	Remote Preview	ECO setup level	Image distribution
	6	Name0212	Group:CAM-***.***.***.***	Power off(Standby)/Audio/ video mute off	192.168.0.11	0	---	Not delivered yet o
	7	NAME4636	Group:G1	Unconnected	---	1	---	---
	8	SQ1-000	Group:CAM-***.***.***.***	Power on:Audio/Video mute off	192.168.0.25	0	---	---
	9	49XF1HJ	Group	Power on:Audio/Video mute off	---	0	---	---
⑤	10	[EOF]						

#### ① Software name

#### ② Version

#### ③ File save date and time

#### ④ Description Items: Device Name

Group (If the group folder of the tree pane is , the camera name set at the time of network camera registration or CAM-XXX (XXX: network camera's IP address) will be displayed as the group name.)

Status (Current status, error/warning information)

Camera

Remote Preview

ECO setup level (displayed numerically)

Image distribution

Signage information

IP Address

Lamp (Lamp 1 to Lamp 4)/Light device Runtime

Closed Caption

Input

Source Signal

Model Name

Wireless Settings

Intake Air Temperature

Optics Module Temperature

Around Air Temperature

OSD Setting

AC Voltage

Serial Number

Geometry

Board Temperature (FP)

Exhaust Temperature (FP)

Intake Air Temperature (FP)

Panel Temperature (FP)

#### ⑤ End-of-file display

## Saving the Information of a Registered Device

---

### Notes

- The content of description items that will be displayed will only be the items currently displayed in the brief information display. To change the items displayed or the display order on the brief information display, see page 234.
- “---” is shown for unsupported information or information that cannot be obtained.

## Saving the Information of a Registered Device

## Importing Device Registration Information

Export data created using this software can be imported.

This function is useful for transferring settings information from another computer that this software is installed.

- Only users with administrator privileges can perform importing. (page 247)

**1** Select [Device Management] → [Import Settings] from the menu.

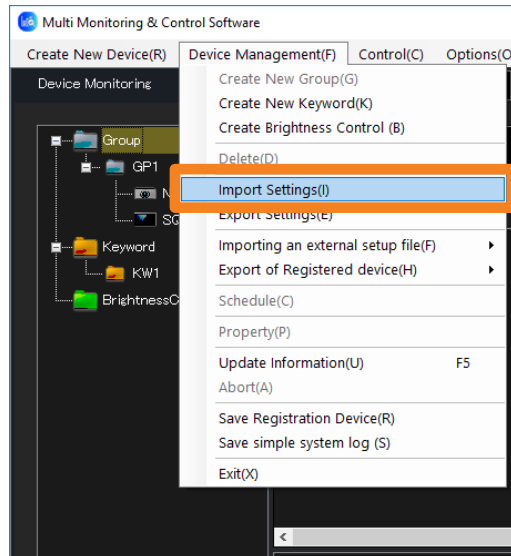

**2** Select the folder containing the file to be imported and click [OK].

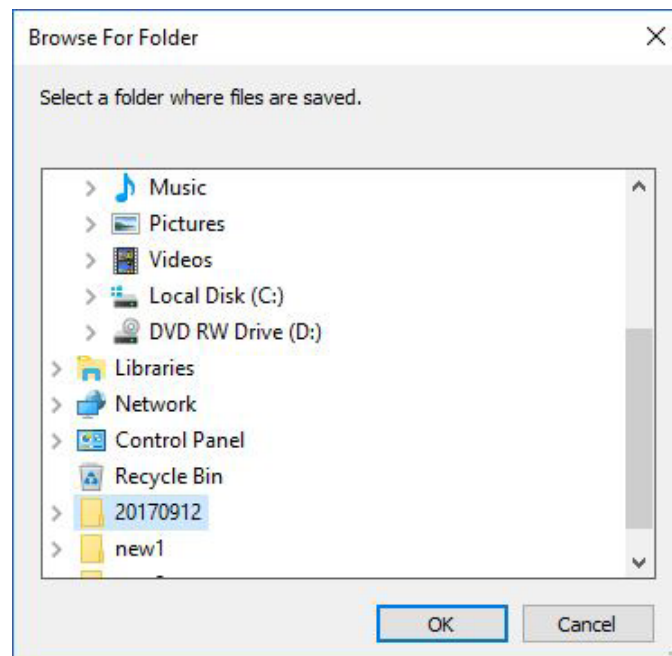

## Saving the Information of a Registered Device

---

### **3 A confirmation dialog will be displayed. Perform the operation in accordance with the information in the message.**

Click [Yes] to start importing.

### **4 When the “imported data successfully” message appears, click [OK].**

- This software restarts automatically, and the various imported setting information items of the computer such as device, group, keyword, brightness control, schedule, and map image by the user's selection are updated.

#### **Notes**

- Items other than devices, groups, keywords, brightness control, schedules, map image by the user's selection, and setting information cannot be imported.
- Export data created using Multi Projector Monitoring & Control Software Ver 1.\* can also be imported into this software (Multi Monitoring & Control Software).
- When “Simultaneous image distribution” is scheduled, the image being used is also imported. Due to the image data size, the file size of import data becomes larger.
- Importing will delete all acquired signage schedules. If a signage schedule is required after importing, acquire the signage schedule again.
- Only the data used by the multi monitoring and control functions is imported. Data from the early warning function is not included.

## Saving the Information of a Registered Device

## Exporting Device Registration Information

Devices, groups, keywords, brightness control, schedules, and setting information that are set up in this software can be exported to a file.

This function is useful when transferring setting information to another computer.

**1 Select [Device Management] → [Export Settings] from the menu.**

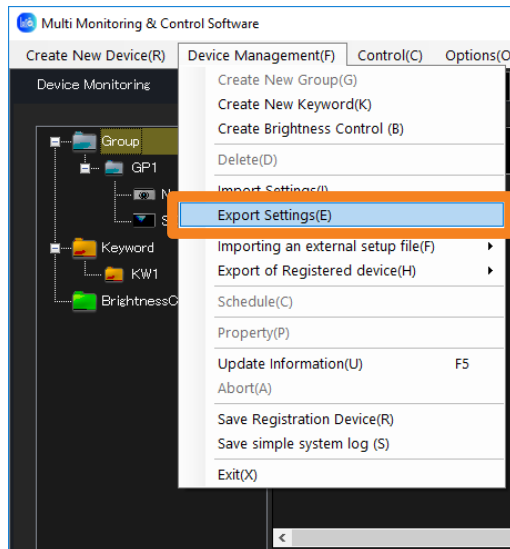

**2 Select export destination and click [OK].**

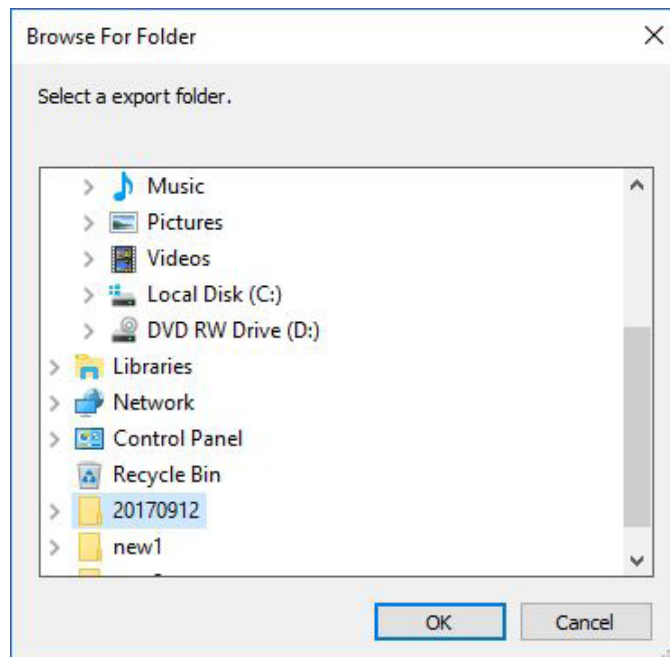

## Saving the Information of a Registered Device

---

### **3 A confirmation message on whether or not the map image will also be exported will be displayed. Operate it according to the content of the message.**

When you click [Yes], the map image registered in each group is copied to the local disk then exported.

### **4 When the “export successful” message appears, click [OK].**

A folder containing the export data is created at the designated export destination and named according to the date and time of export.

Example: Name of data folder if export is performed at 19:56:48 on January 13, 2017:  
20170113195648

#### **Notes**

- Items other than devices, groups, keywords, brightness control, schedules, setting information, and map image by the user's selection cannot be exported using this function. (The data accumulated by the early warning function and license information is not exported.)
- When “Simultaneous image distribution” is scheduled, the selected image is also exported. Depending on the image data size, the file size of the export data may become large, and it may take time to perform export process.
- Do not import the export data created with this software (Multi Monitoring & Control Software) into Multi Projector Monitoring & Control Software Ver 2.0, Ver 2.5, Ver 2.6, Ver 2.7, Ver 2.8, Ver 2.9, Ver 3.0, Ver 3.1 and Multi Monitoring & Control Software Ver 1.0. The software may stop operating.

# Controlling Devices

## Executing a Control Command

Devices can be controlled on an individual device basis, or on the basis of group, keyword, or brightness control.

### Attention

- When turning the projector on, take care to ensure that light from the light source cannot enter the eyes of people near the projector.

- 1 From the tree pane of the <Device Monitoring> window, select the icon for the device, group, keyword, or brightness control that is the target of the control command.
- 2 Select [Control] → [Control Command] from the menu.

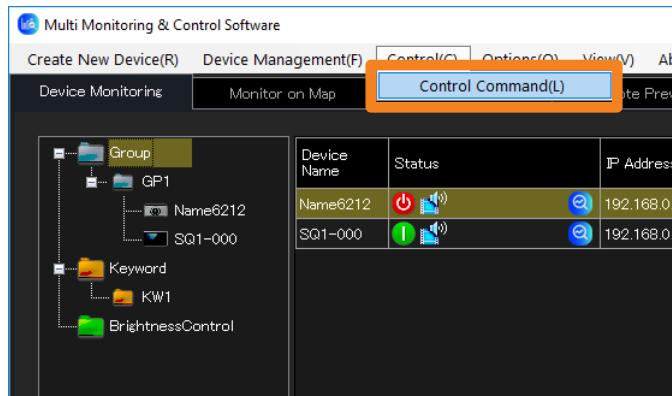

- 3 Select and click the command to be executed.

- You can execute a control command repeatedly by repeating the command execution steps.
- The result of executing the control command will be displayed under [Command Execution Result] (①) and in the “Command execution log pane” (page 37). If an invalid control command is executed or a timeout occurs, [NG] is displayed.

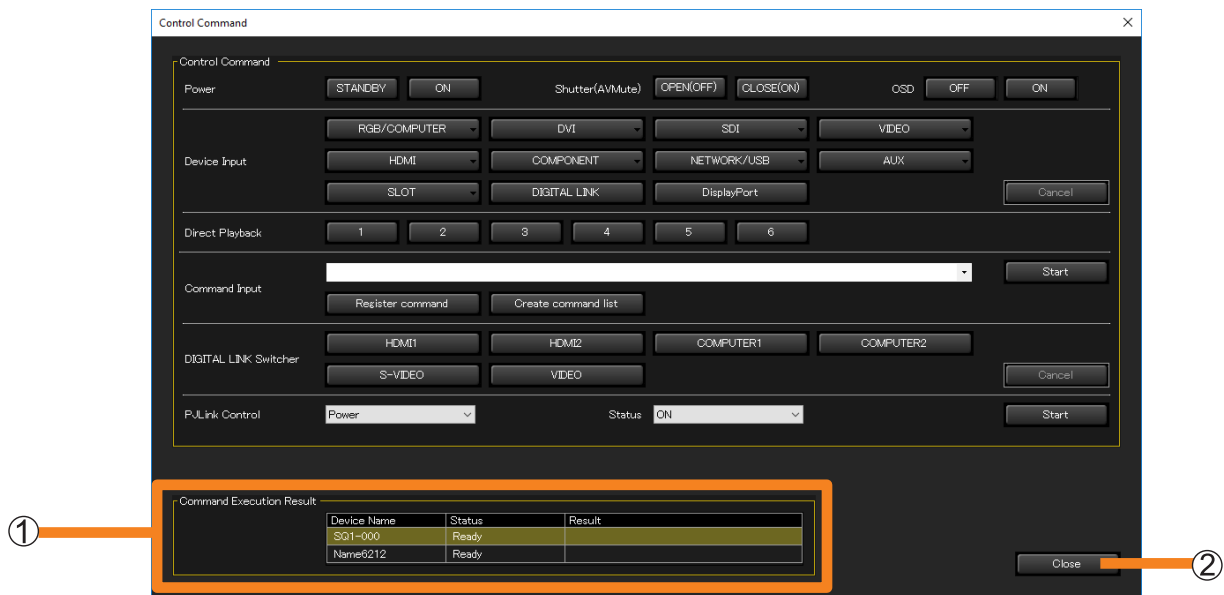



## Executing a Control Command

[Power]	<b>Command to use: PJLink command*</b> <sup>3</sup> Off/on control for the power.
[Shutter(AVMute)]	<b>Command to use: PJLink command*</b> <sup>3</sup> Open/close control for the shutter or off/on control for AV mute.
[OSD]	<b>Command to use: Proprietary command</b> Controls if the Projector's OSD information will be displayed or not.
[Device Input]	<b>Command to use: PJLink command</b> Click an input terminal to select it. (For items with a [▼], hovering the mouse pointer shows the available choices.) <ul style="list-style-type: none"> <li>• Operations not listed under [Device Input] are carried out by selecting combinations of [PJLink Control] and [Status].</li> </ul>
[Direct Playback]* <sup>1</sup>	<b>Command to use: Proprietary command</b> The buttons numbered [1] to [6] work the same way as the numbered buttons on the remote control supplied with the device.
[Command Input]* <sup>2</sup>	<b>Command to use: Proprietary command</b> Enter the command, and click [Start]. The device is controlled according to the contents of the command entered. (You can select registered commands from a pull-down menu.) <b>[Register command]:</b> You can register commonly used commands. (page 114) <b>[Create command list]:</b> Creates a list of commands, allowing for easy sequence control. (page 115) <ul style="list-style-type: none"> <li>• After the software starts, you cannot use [Start] with a command until the device information has been updated. First update the device information, then click [Start] for a command. (page 112)</li> <li>• This method cannot be used for switching of the Digital Interface Box and DIGITAL LINK Switcher inputs.</li> </ul>
[DIGITAL LINK Switcher]	<b>Command to use: Proprietary command</b> Select this to switch the input of the DIGITAL LINK Switcher.
[PJLink Control] / [Status]	<b>Command to use: PJLink command*</b> <sup>3</sup> Select the operation to be executed by creating a combination of [PJLink Control] and [Status]. <ul style="list-style-type: none"> <li>• For more information about the combinations, see page 118.</li> </ul>

\*<sup>1</sup> [Direct Playback] only works on devices that support the "Signage Schedule Acquisition and Delivery Functions".

\*<sup>2</sup> [Command Input] only works on devices that support the "Command Transmission Function".

\*<sup>3</sup> Panasonic displays (such as projectors and flat panel displays) supporting PJLink can perform the operations that use the PJLink command.

#### 4 Click [Close] (Ⓜ) to close the <Control Command> window.

## Executing a Control Command

### ■ Registering and transmitting commands (maximum of 20)

1 Click [Register command] for [Command Input].

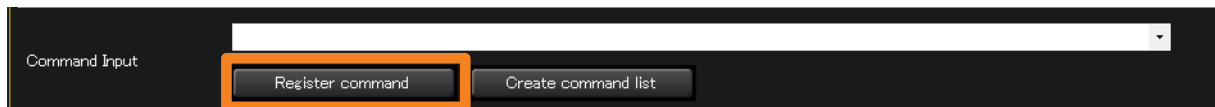

2 Enter the command you want to register.

- If you read in command information (CSV format) (page 117) using [Read File] (①), you can then select the read-in commands from a pull-down menu.

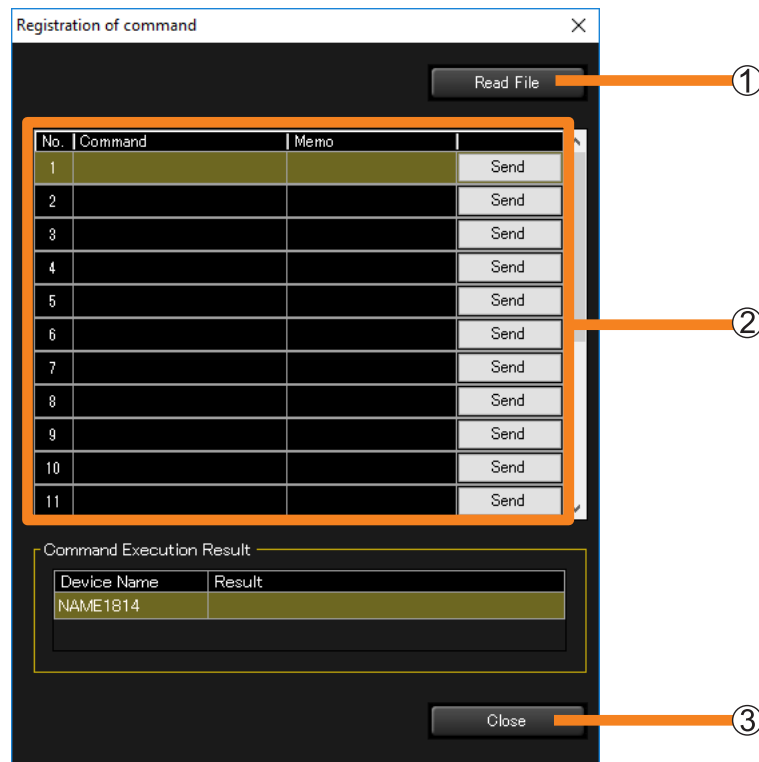

② **[Command]:** Enter a command directly, or select a read-in command from a pull-down menu.

**[Memo]:** If necessary, enter additional information here (maximum: 128 half-width or 64 full-width characters).

**[Send]:** Transmit the command you entered to the device.

3 Click [Close] (③) to close the window.

The command you entered is registered.

- Registered commands can be selected from a pull-down menu on the [Control Command] window when entering commands.

#### Notes

- After the software starts, you cannot transmit commands until the device information has been updated. First update the device information, then transmit a command.

## Executing a Control Command

### ■ Creating and transmitting command list (maximum of 100)

1 Click [Create command list] for [Command Input].

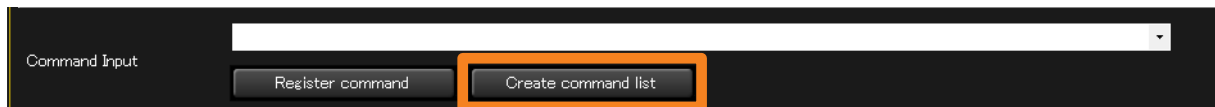

2 Add an input line with [Add line] (①), and enter a command.

- When you enter the execution file name of the application installed in your computer, you can start the application. (When startup has failed, nothing will be displayed.)
- ① After entering @ (at sign), enter the full path of the execution file, and enclose the path in " " (double quotation marks).
- ② When parameters are necessary, enter a single-byte space after ①, and add the parameters enclosed in " " (double quotation marks).
  - When parameters are included in the file, specify the full path.

Example: @ "C:\Program Files\TEST\test.exe" /P " /B"

①

②

- If you read in a command list (CSV format) (page 117) using [Read file] (②), you can then select the read-in commands from a pull-down menu.

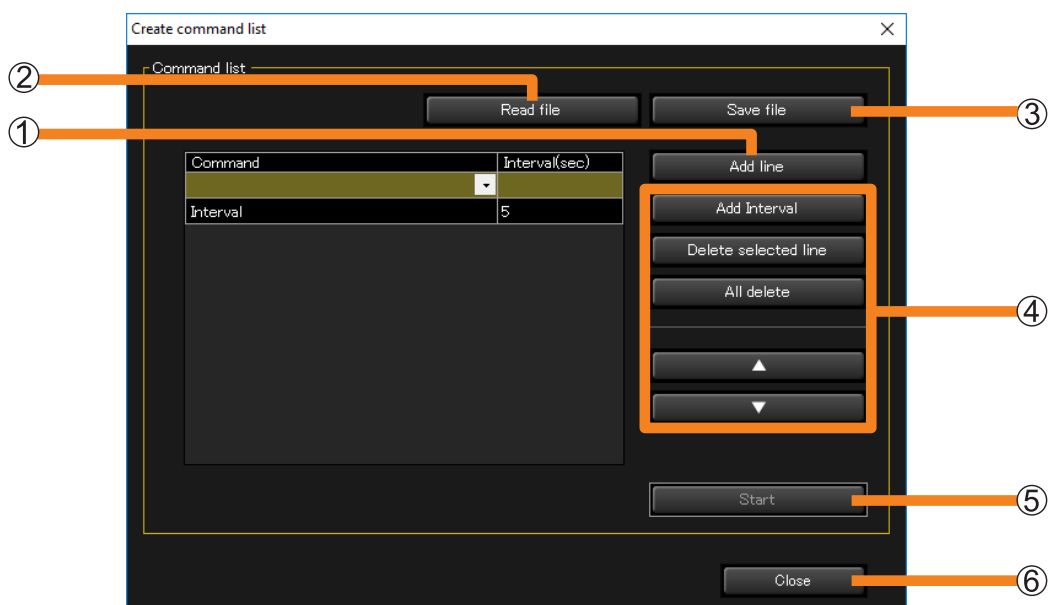

- ④ **[Add Interval]:** Add a line with the Interval (wait time) command. You can set the execution interval before and after the Interval command from 0 to 999 seconds.
- [Delete selected line]:** Delete the selected command.
- [All delete]:** Delete all commands from the list.
- [▲] / [▼]:** Change the order of the selected command in the list.

## Executing a Control Command

---

### **3 Click [Start] (⑤).**

Commands are transmitted to the target device in order, starting from the top of the command list.

- If you quit without clicking [Start], the list you created is deleted. To retain the command list you created, click [Save file] (③) to save the list in CSV format to a folder of your choice.

### **4 Click [Close] (⑥) to close the window.**

#### **Notes**

- After the software starts, you cannot transmit commands until the device information has been updated. First update the device information, then transmit commands.
- You can perform command input and list reading from the <Create Schedule> window (page 128) as well. Commands created at the <Create Schedule> window are added to the schedule and executed on the set time and date.

## Executing a Control Command

### ■ Creating command information

Use [Register command] to create command information conforming to the following conditions that can be read into the software.

- File format: CSV
- Character code: EUC / UTF-8 / Shift\_JIS
- The maximum number of commands that can be read in is 20.
- The command information consists of one command per line, with each line ending with a comma (,) and a line break.
- To enter a comment line, omit the comma (,) at the end of the line.

Example: Power ON  
Power OFF

PON, Power ON [line break]  
POF, [line break]

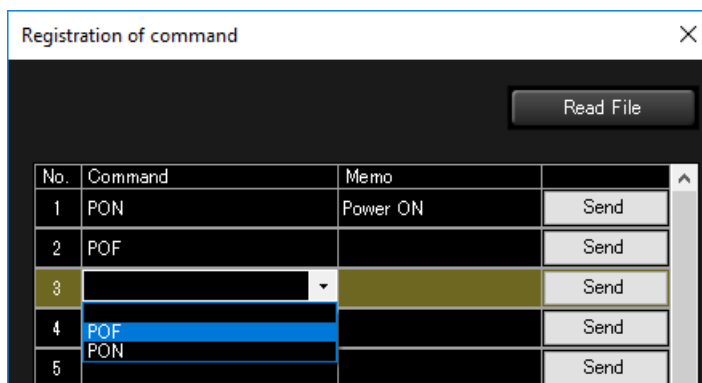

### ■ Creating a command list

Use [Create command list] to create a command list conforming to the following conditions that can be read into the software.

- File format: CSV
- The maximum number of commands that can be read in is 100.
- The command information consists of one command per line, with each line ending with a comma (,) and a line break.
- To insert an interval between commands, add the Interval command ("Interval,XX" (XX: enter a wait time of 0 to 999 seconds)) between the commands between which you wish to insert an interval.

Example: Turn on power, then turn off power after 20 seconds.

PON, [line break]  
Interval, 20 [line break]  
POF, [line break]

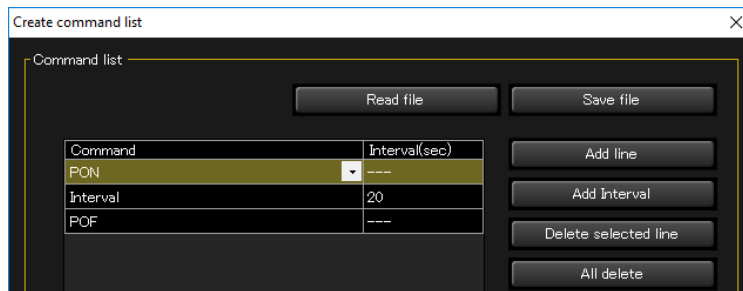

## Executing a Control Command

## ■ Combinations of [PJLink Control] and [Status]

[PJLink Control]	[Status]	Combination result
[Power]	[OFF]	Power OFF
	[ON]	Power ON
[Input RGB]	[1]	Switching to the RGB input that corresponds to parameter "11" of the PJLink input switching command INPT.
	[2]	Switching to the RGB input that corresponds to parameter "12" of the PJLink input switching command INPT.
	[3]	Switching to the RGB input that corresponds to parameter "13" of the PJLink input switching command INPT.
	[4]	Switching to the RGB input that corresponds to parameter "14" of the PJLink input switching command INPT.
	[5]	Switching to the RGB input that corresponds to parameter "15" of the PJLink input switching command INPT.
	[6]	Switching to the RGB input that corresponds to parameter "16" of the PJLink input switching command INPT.
	[7]	Switching to the RGB input that corresponds to parameter "17" of the PJLink input switching command INPT.
	[8]	Switching to the RGB input that corresponds to parameter "18" of the PJLink input switching command INPT.
	[9]	Switching to the RGB input that corresponds to parameter "19" of the PJLink input switching command INPT.
	[A] to [Z]	Switching to the RGB input that corresponds to parameter "1A" to "1Z" of the PJLink 2 input switching command INPT.
[Input VIDEO]	[1]	Switching to the VIDEO input that corresponds to parameter "21" of the PJLink input switching command INPT.
	[2]	Switching to the VIDEO input that corresponds to parameter "22" of the PJLink input switching command INPT.
	[3]	Switching to the VIDEO input that corresponds to parameter "23" of the PJLink input switching command INPT.
	[4]	Switching to the VIDEO input that corresponds to parameter "24" of the PJLink input switching command INPT.
	[5]	Switching to the VIDEO input that corresponds to parameter "25" of the PJLink input switching command INPT.
	[6]	Switching to the VIDEO input that corresponds to parameter "26" of the PJLink input switching command INPT.
	[7]	Switching to the VIDEO input that corresponds to parameter "27" of the PJLink input switching command INPT.
	[8]	Switching to the VIDEO input that corresponds to parameter "28" of the PJLink input switching command INPT.
	[9]	Switching to the VIDEO input that corresponds to parameter "29" of the PJLink input switching command INPT.
	[A] to [Z]	Switching to the VIDEO input that corresponds to parameter "2A" to "2Z" of the PJLink 2 input switching command INPT.

## Executing a Control Command

[PJLink Control]	[Status]	Combination result
[Input DIGITAL]	[1]	Switching to the DIGITAL input that corresponds to parameter "31" of the PJLink input switching command INPT.
	[2]	Switching to the DIGITAL input that corresponds to parameter "32" of the PJLink input switching command INPT.
	[3]	Switching to the DIGITAL input that corresponds to parameter "33" of the PJLink input switching command INPT.
	[4]	Switching to the DIGITAL input that corresponds to parameter "34" of the PJLink input switching command INPT.
	[5]	Switching to the DIGITAL input that corresponds to parameter "35" of the PJLink input switching command INPT.
	[6]	Switching to the DIGITAL input that corresponds to parameter "36" of the PJLink input switching command INPT.
	[7]	Switching to the DIGITAL input that corresponds to parameter "37" of the PJLink input switching command INPT.
	[8]	Switching to the DIGITAL input that corresponds to parameter "38" of the PJLink input switching command INPT.
	[9]	Switching to the DIGITAL input that corresponds to parameter "39" of the PJLink input switching command INPT.
	[A] to [Z]	Switching to the DIGITAL input that corresponds to parameter "3A" to "3Z" of the PJLink 2 input switching command INPT.
[Input STORAGE]	[1]	Switching to the STORAGE input that corresponds to parameter "41" of the PJLink input switching command INPT.
	[2]	Switching to the STORAGE input that corresponds to parameter "42" of the PJLink input switching command INPT.
	[3]	Switching to the STORAGE input that corresponds to parameter "43" of the PJLink input switching command INPT.
	[4]	Switching to the STORAGE input that corresponds to parameter "44" of the PJLink input switching command INPT.
	[5]	Switching to the STORAGE input that corresponds to parameter "45" of the PJLink input switching command INPT.
	[6]	Switching to the STORAGE input that corresponds to parameter "46" of the PJLink input switching command INPT.
	[7]	Switching to the STORAGE input that corresponds to parameter "47" of the PJLink input switching command INPT.
	[8]	Switching to the STORAGE input that corresponds to parameter "48" of the PJLink input switching command INPT.
	[9]	Switching to the STORAGE input that corresponds to parameter "49" of the PJLink input switching command INPT.
	[A] to [Z]	Switching to the STORAGE input that corresponds to parameter "4A" to "4Z" of the PJLink 2 input switching command INPT.

## Executing a Control Command

[PJLink Control]	[Status]	Combination result
[Input NETWORK]	[1]	Switching to the NETWORK input that corresponds to parameter "51" of the PJLink input switching command INPT.
	[2]	Switching to the NETWORK input that corresponds to parameter "52" of the PJLink input switching command INPT.
	[3]	Switching to the NETWORK input that corresponds to parameter "53" of the PJLink input switching command INPT.
	[4]	Switching to the NETWORK input that corresponds to parameter "54" of the PJLink input switching command INPT.
	[5]	Switching to the NETWORK input that corresponds to parameter "55" of the PJLink input switching command INPT.
	[6]	Switching to the NETWORK input that corresponds to parameter "56" of the PJLink input switching command INPT.
	[7]	Switching to the NETWORK input that corresponds to parameter "57" of the PJLink input switching command INPT.
	[8]	Switching to the NETWORK input that corresponds to parameter "58" of the PJLink input switching command INPT.
	[9]	Switching to the NETWORK input that corresponds to parameter "59" of the PJLink input switching command INPT.
	[A] to [Z]	Switching to the NETWORK input that corresponds to parameter "5A" to "5Z" of the PJLink 2 input switching command INPT.
[AVMute VIDEO]*	[ON]	AV mute (video only) ON/shutter closed
	[OFF]	AV mute (video only) OFF/shutter open
[AVMute AUDIO]*	[ON]	AV mute (audio only) ON
	[OFF]	AV mute (audio only) OFF
[AVMute VIDEO + AUDIO]	[ON]	AV mute (video and audio) ON/shutter closed
	[OFF]	AV mute (video and audio) OFF/shutter open

\* Panasonic devices are not currently supported.

## Notes

- For details on the compatible functions of each device, refer to the "List of Compatible Device Models" of this application software which is posted on the following website.  
<https://panasonic.net/cns/projector/download/application/>  
<https://panasonic.net/cns/prodisplays/download/software/>
- For details on individual functions and device-side operations, refer to the instruction manual of the device or peripheral device.
- If an input switching command that does not exist for a particular model has been set, "Unsupported" will be displayed in [Command Execution Result] and in the command execution log pane of the <Device Monitoring> window.
- TH-D3500 does not support the [Device Input].
- Switching of the Digital Interface Box inputs can be executed only when a Digital Interface Box is connected to a device that supports DIGITAL LINK.
- Switching of the DIGITAL LINK Switcher inputs can be executed only when a DIGITAL LINK Switcher is connected to a device that supports DIGITAL LINK.
- When the Digital Interface Box or DIGITAL LINK Switcher switch command is sent to a device that does not support DIGITAL LINK, "Unsupported" is displayed at [Command Execution Result] and in the command execution log display area of the <Device Monitoring> window.



## Executing a Control Command

### Saving or Deleting the Log

You can save and delete the log information displayed in the log pane.

#### Notes

- Up to 10,000 log entries can be saved. Once 10,000 log entries are reached, old log entries are deleted to make room for new ones.

### 1 Right-click on the command execution log pane of the <Device Monitoring> window to display the <Menu> window.

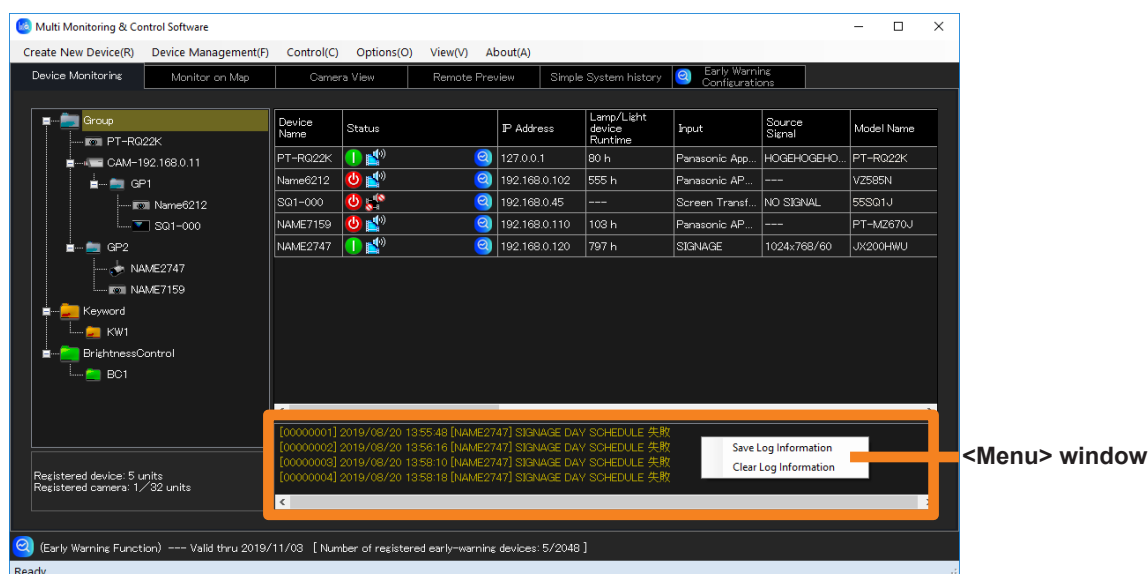

### 2 Select [Save Log Information] or [Clear Log Information].

**[Save Log Information]:** The log information is saved in CSV format in the specified folder.

**[Clear Log Information]:** The log information displayed in the log pane is deleted.

## Scheduling Function

**1** From the tree pane of the <Device Monitoring> window, select the icon for the device, group, or device-registered keyword or brightness control group whose schedule is to be set, right-click it, and select [Schedule].

- Alternatively, you can use the following method.
  - Select [Device Management] → [Schedule] from the menu.

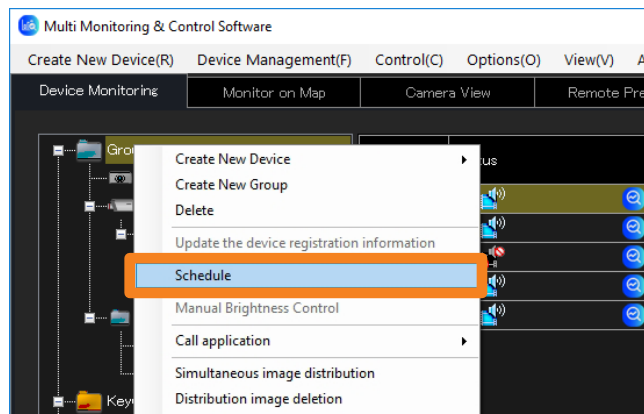

**2** On the schedule setting screen, select from the following operations.

- ① [Date and time specification]: Select the date and time specification to view what has already been scheduled.
- ② [Schedule addition]: Create a new schedule. (Go to step **3** in page 123)
- ③ [Edit]: Edit the selected schedule. (Go to step **3** in page 123)
- ④ [Delete]: Remove the selected schedule. (Go to step **4** in page 123)

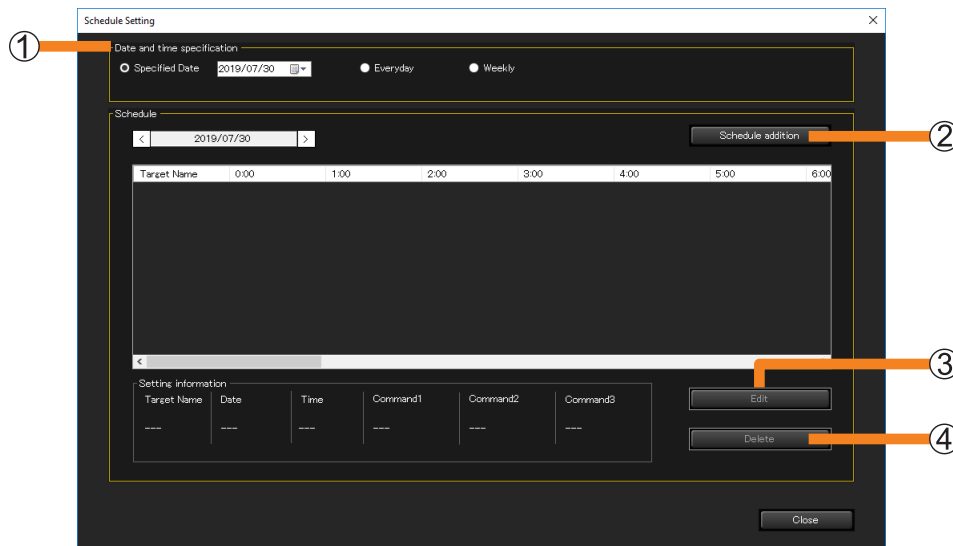

## Scheduling Function

### 3 Select the date and time, the control function to be executed, and the order to perform the operation, and then click [OK] (5).

- The following is the screen when [Schedule addition] is selected. If [Edit] is selected, the settings will be the same.

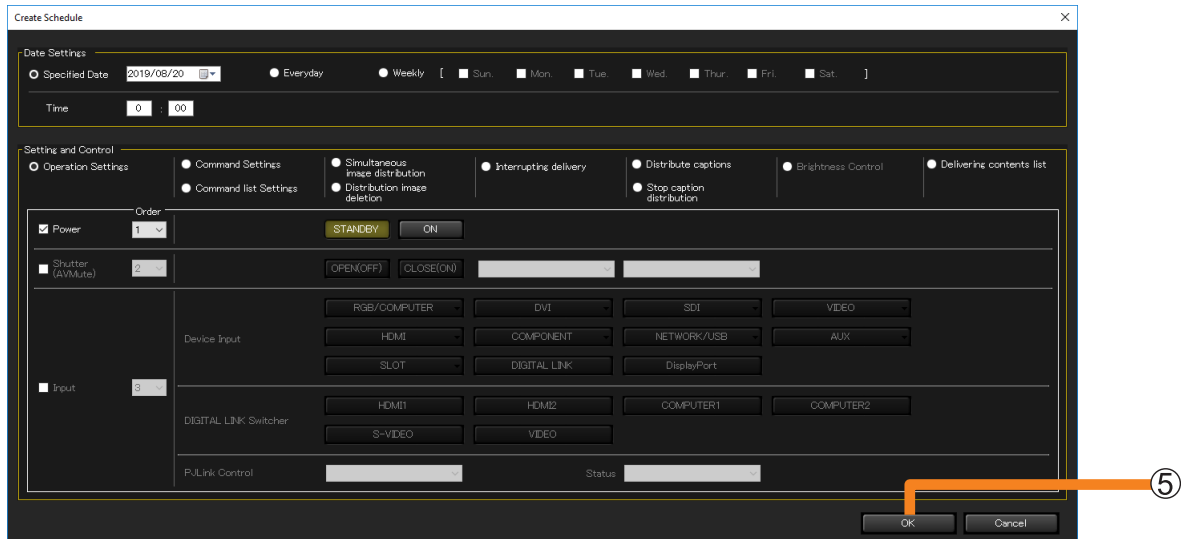

<b>[Date Settings]</b>	Select [Specified Date], [Everyday], or [Weekly] (by day of the week) and then set [Time]. (You cannot set a time that is before the creation date and time.)
<b>[Setting and Control]</b>	<p>Select one of the following items and set the execution details.</p> <ul style="list-style-type: none"> <li>• [Operation Settings] (page 125)</li> <li>• [Command Settings] (page 126)</li> <li>• [Command list Settings] (page 128)</li> <li>• [Simultaneous image distribution] (page 130)</li> <li>• [Distribution image deletion] (page 130)</li> <li>• [Interrupting delivery] (page 139)</li> <li>• [Distribute captions] (page 143)</li> <li>• [Stop caption distribution] (page 143)</li> <li>• [Brightness Control] (page 151)</li> <li>• [Delivering contents list] (page 154)</li> </ul>

### 4 Return to the screen in step 2 and click [Close].

- When the schedule settings are done, (J) will appear in the tree pane of the <Device Monitoring> window. If the schedule is deleted, the (J) disappears.

#### Notes

- When using the schedule settings to power on a projector, the schedule should only be set up for a projector installed in an environment where light from the projector cannot enter the eyes of nearby people when the projector starts.
- Up to 100 schedules can be set.
- To see if the equipment being used supports a particular control function, refer to the “List of Compatible Device Models” of this application software which is posted on the following website.  
<https://panasonic.net/cns/projector/download/application/>  
<https://panasonic.net/cns/prodisplays/download/software/>

## Scheduling Function

## Checking schedules that have been set up

You can view a list of the schedules that have been set up.

**1** Select [Options] → [All Schedule List] from the menu.

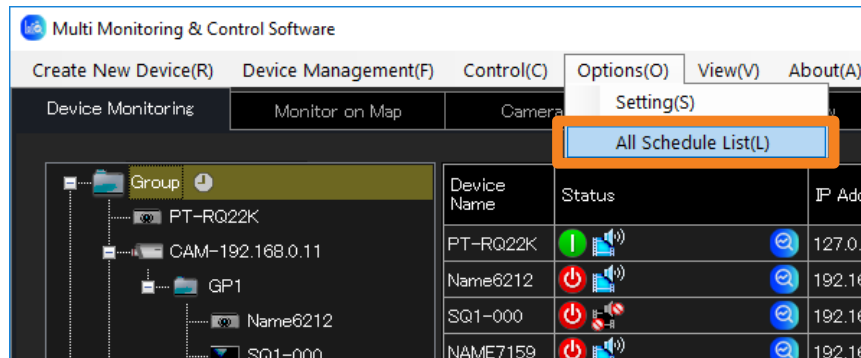

Device Name	Set Position	Date	Command1	Command2	Command3
Name6212	G : Group	7/23/2019 10:...	POWER OFF	AVMUTE VIDEO...	INPUT RGB2
Name6212	G : Group	8/21/2019 1:0...	SEND LIGHT ID ...		
SQ1-000	G : Group	7/23/2019 10:...	POWER OFF	AVMUTE VIDEO...	INPUT RGB2
SQ1-000	P : SQ1-000	8/10/2019 5:0...	DELIVERING C...		
SQ1-000	G : Group	8/21/2019 1:0...	SEND LIGHT ID ...		
NAME7159	G : Group	7/23/2019 10:...	POWER OFF	AVMUTE VIDEO...	INPUT RGB2
NAME7159	P : 65SQ1J	7/30/2019 3:0...	DISTRIBUTE C...		
NAME7159	G : Group	8/21/2019 1:0...	SEND LIGHT ID ...		
RQ50K	G : Group	7/23/2019 10:...	POWER OFF	AVMUTE VIDEO...	INPUT RGB2
RQ50K	G : Group	8/21/2019 1:0...	SEND LIGHT ID ...		
NAME2747	G : Group	7/23/2019 10:...	POWER OFF	AVMUTE VIDEO...	INPUT RGB2
NAME2747	G : Group	8/21/2019 1:0...	SEND LIGHT ID ...		
DZ16K	G : Group	7/23/2019 10:...	POWER OFF	AVMUTE VIDEO...	INPUT RGB2
DZ16K	G : Group	8/21/2019 1:0...	SEND LIGHT ID ...		
DZ21K2	G : Group	7/23/2019 10:...	POWER OFF	AVMUTE VIDEO...	INPUT RGB2

- If there are overlapping schedules for a specified device, its lines will be indicated in red. If there are overlapping schedules (with the same start time specified for multiple commands for the same device), proper operation of the device cannot be guaranteed. To change an overlapping schedule, select [Edit] or [Delete] in step **2** of “Scheduling Function”. (page 122)
- The <Schedule List> window displays a list of schedules that have been set up for each device. Schedules for up to 100 devices can be displayed at any one time. If there are schedules for more than 100 devices, buttons for moving between pages, the page number, and the total number of pages will appear at the bottom of the window.

## Controlling Devices by Selecting Commands to be Sent ([Operation Settings])

### ■ Configuration by specifying a date and time in [Schedule]

- 1 Select the icon for the desired device, group, or keyword from the tree pane of the <Device Monitoring> window, right-click it, and select [Schedule]. (page 122)
- 2 On the schedule setting screen, click [Schedule addition] or [Edit].
- 3 Specify the date and time, and select [Operation Settings].
  - Select [Specified Date], [Everyday], or [Weekly] (by day of the week) and then set [Time].

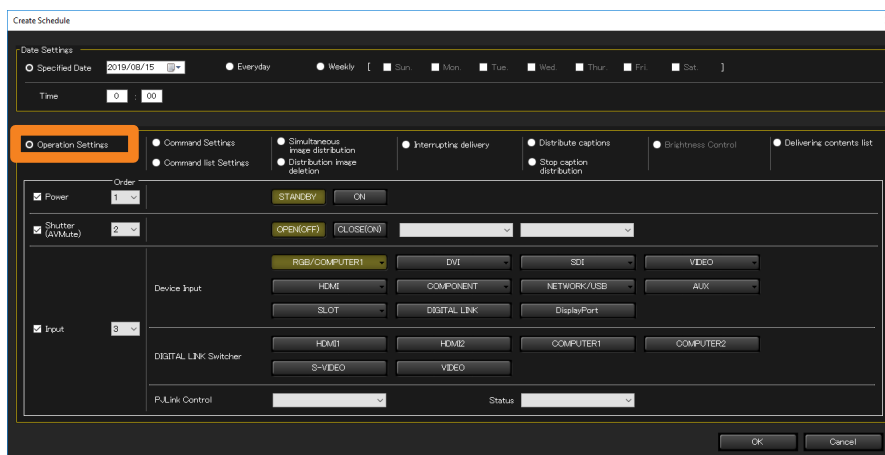

- 4 Select the check boxes of the items to be controlled, and then configure their settings.

[Power]	Off/on control for the power.
[Shutter (AVMute)]	Open/close control for the shutter or off/on control for AV mute. <ul style="list-style-type: none"> <li>• To control AUDIO and VIDEO individually, select either [VIDEO], [AUDIO], or [VIDEO + AUDIO] from the left-side pull-down menu and select [ON] or [OFF] from the right-side pull-down menu.</li> </ul>
[Input]	<p><b>[Device Input]:</b> Select this to switch the input to the device. (For items with [▼], hovering the mouse pointer shows the available choices.)</p> <p><b>[DIGITAL LINK Switcher]:</b> Select this to switch the input of the Digital Interface Box or DIGITAL LINK Switcher.</p> <ul style="list-style-type: none"> <li>• Click an input terminal to select it.</li> <li>• If you want to execute individual control, select the operation to be executed by creating a combination of [PLink Control] and [Status].</li> </ul> <p><b>[PLink Control] / [Status]:</b> Select the operation to be executed by creating a combination of [PLink Control] and [Status].</p> <ul style="list-style-type: none"> <li>• For more information about the combinations, see page 118.</li> </ul>

- 5 Use the [Order] selectors to specify the order of the operations and then click [OK].

The content set will be added to the schedule.

# Configuring Devices by Entering Commands

([Command Settings])

The commands that can be set and the periods for disabling command reception vary depending on the device you are using. For details, refer to the instruction manual for your device.

## ■ Configuration by specifying a date and time in [Schedule]

**1** Select the icon for the desired device, group, or keyword from the tree pane of the <Device Monitoring> window, right-click it, and select [Schedule].

(page 122)

**2** On the schedule setting screen, click [Schedule addition] or [Edit].

**3** Specify the date and time, and select [Command Settings].

- Select [Specified Date], [Everyday], or [Weekly] (by day of the week) and then set [Time].

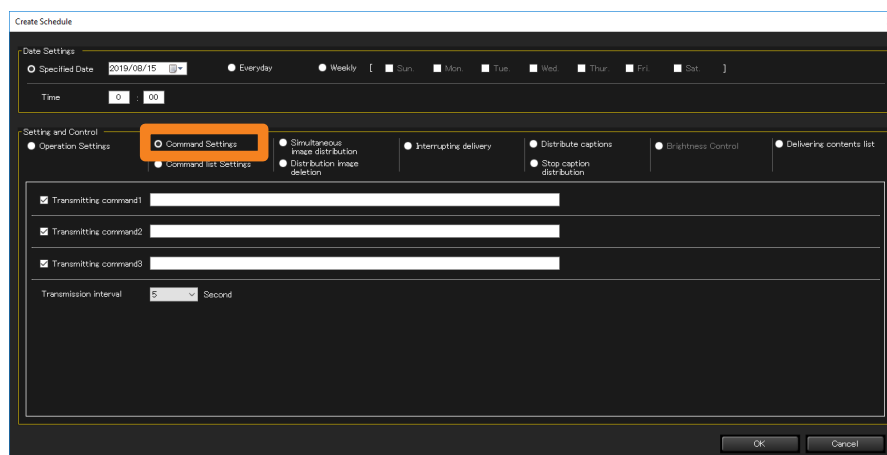

**4** Enter the command to send in [Transmitting command].

You can only use single byte capital/small letters (alphabet), numbers, and symbols. You can enter up to 256 characters.

- When you enter the execution file name of the application installed in your computer, you can start the application. (When the start has failed, nothing will be displayed.)
  - ① In [Transmitting command1], after entering @ (at sign), enter the full path of the execution file, and enclose the path in " " (double quotation marks).
  - ② When parameters are necessary, after entering @ (at sign), enter parameters in [Transmitting command2] and [Transmitting command3], and enclose them in " " (double quotation marks), respectively.

Example: [Transmitting command1]: @"C:\Program Files\\*\*\*\test.exe" (execution file)

[Transmitting command2]: @"/P" (parameter)

[Transmitting command3]: @"C:\Document\\*\*\*\text.txt" (When parameters are included in the file)

**5** Put a check on the commands to send. (All commands are checked by default.)

Checked commands will be sent in order from the top.

### Configuring Devices by Entering Commands ([Command Settings])

---

#### **6 Set the command sending interval in [Transmission interval].**

Select [5], [10], [15], or [30] seconds as the sending interval for multiple commands (up to 3 commands can be sent). (Default setting value: 5 seconds)

- The number of seconds that you select in [Transmission interval] will be invalid, if a call command is entered at Step **4**.

#### **7 Click [OK].**

The content set will be added to the schedule.

## Configuring a Command List ([Command list Settings])

You can register created command lists (page 117) to the schedule.

### ■ Configuration by specifying a date and time in [Schedule]

- 1** Select the icon for the desired device, group, or keyword from the tree pane of the <Device Monitoring> window, right-click it, and select [Schedule]. (page 122)
- 2** On the schedule setting screen, click [Schedule addition] or [Edit].
- 3** Specify the date and time, and select [Command list Settings].
  - Select [Specified Date], [Everyday], or [Weekly] (by day of the week) and then set [Time].

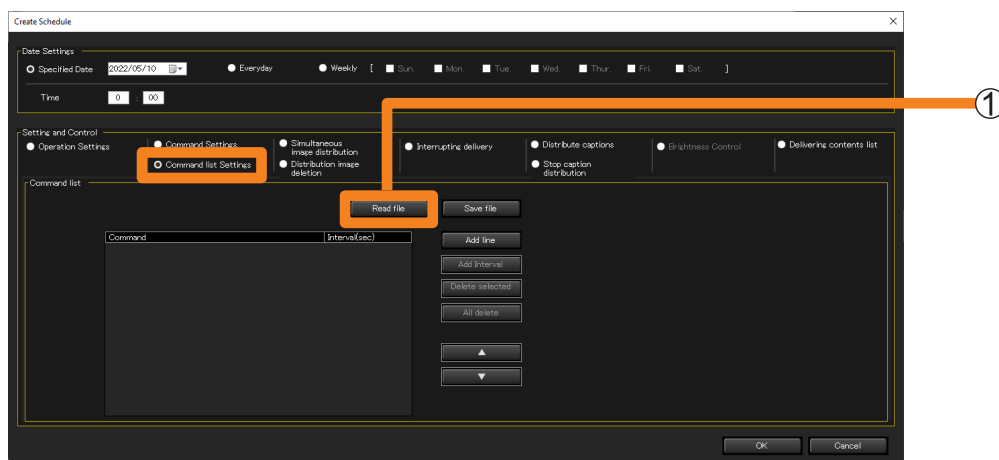

### **4** Click [Read file] (①).

- Read the command list (CSV format) to be registered to the schedule. (Maximum of 100 lists)

### **5** Select the command list you want to read, and click [Open].

When the reading success message is displayed, click [OK].

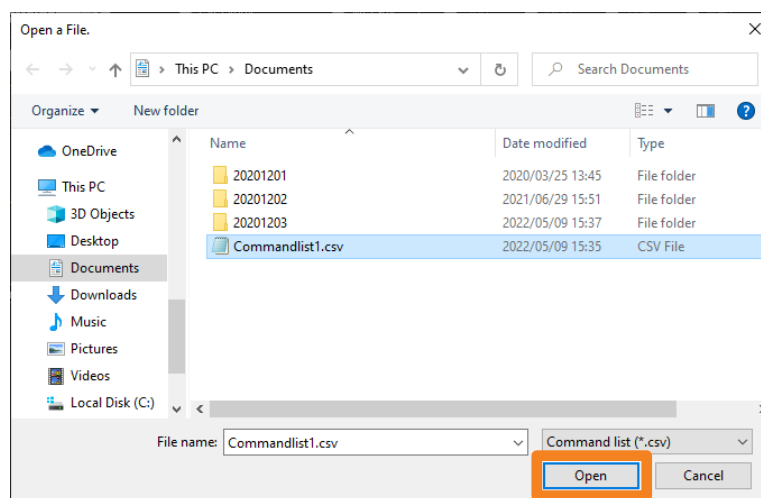



## Configuring a Command List ([Command list Settings])

**6 Select the command you want to register from the pull-down menu of the read command list.**

- You can also delete the read command or adjust its interval (②).

**[Add line]:** Add a command input line.

**[Add Interval]:** Add a line with the Interval (wait time) command. You can set the execution interval before and after the Interval command from 0 to 999 seconds.

**[Delete selected]:** Delete the selected command.

**[All delete]:** Delete all commands from the list.

**[▲] / [▼]:** Change the order of the selected command in the list.

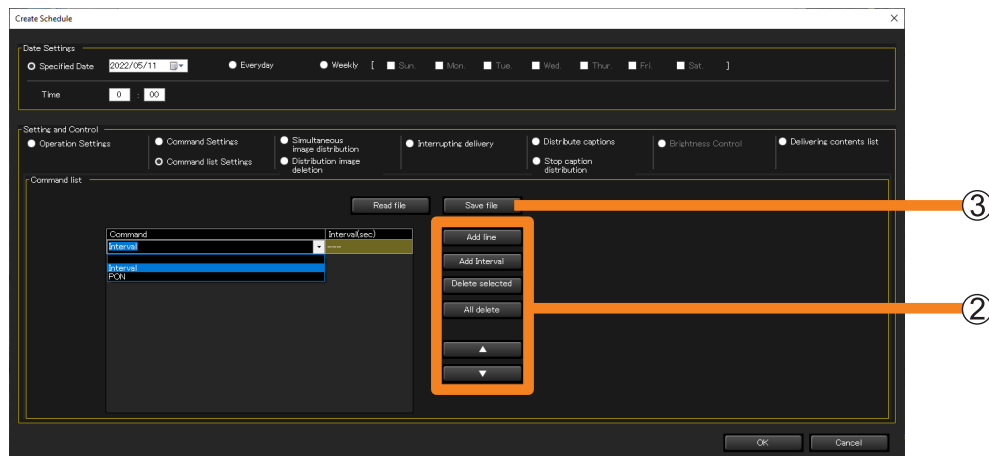
**7 Click [OK].**

- The set command list will be added to the schedule.
- If you click [Cancel] without clicking [OK], the set command list will be deleted. To retain the command list you set, click [Save file] (③) to save the list in a CSV format to a folder of your choice.

## Delivering/Deleting Images

([Simultaneous image distribution] / [Distribution image deletion])

**[Simultaneous image distribution]:** This is a function to deliver and display specified image data to multiple devices. Additionally, characters can also be delivered superimposed on the images using the simple edit function. (page 132)

**[Distribution image deletion]:** This is a function to set multiple devices to the initial Panasonic APPLICATION input screen. If a delivered image is being displayed, the image can be deleted. Depending on the device, the screen may turn all black. (page 136)

### ■ Specifications for files that can be delivered

<b>File type</b>	JPEG format and BMP format image files that the OS gives standard support (extension: .jpg/.jpeg/.bmp)
<b>Deliverable image size (image resolution)</b>	Up to 4,096×2,160 pixels (delivered after resizing to XGA (1,024×768) size or WXGA (1,280×800) size.)

- To see if the equipment being used supports [Simultaneous image distribution] and [Distribution image deletion], refer to the “List of Compatible Device Models” of this application software which is posted on the following website.  
<https://panasonic.net/cns/projector/download/application/>  
<https://panasonic.net/cns/prodisplays/download/software/>

#### Notes

- When [Simultaneous image distribution] or [Distribution image deletion] is performed, the device input switches to NETWORK or Panasonic APPLICATION, and remains on NETWORK or Panasonic APPLICATION input even after the completion of distribution or deletion. If the device input does not switch to NETWORK or Panasonic APPLICATION, press the “Panasonic APP” button or “NETWORK/USB” button on the remote control to change the input to “Panasonic APPLICATION”. Then, perform the simultaneous image distribution again.
- If [Display option] → [Onscreen display] → [Input guide] is set to other than Off in the device menu, and [Simultaneous image distribution] or [Distribution image deletion] is performed, the device input switches to NETWORK or Panasonic APPLICATION input, and at the same time, the input guide is momentarily displayed on the screen. In some models, after switching to NETWORK or Panasonic APPLICATION input, the input guide may continue to be displayed for about 5 minutes.
- If you do not want the input guide to be displayed when [Simultaneous image distribution] or [Distribution image deletion] is performed, set [Display option] → [Onscreen display] → [Input guide] to Off in the device menu.
- In some models, when this software is started up, an undelivered status icon is displayed in the Brief Information Display regardless of the state of the device.
- Images cannot be delivered by performing [Simultaneous image distribution] for devices in which the computer screen is displayed by using the Panasonic Connect Co., Ltd. application software “Wireless Manager ME” used for image transfer, or “Plug and Share”. However, you can deliver images by selecting [Live mode interrupt] or [Panasonic APPLICATION] from the [Network] menu and setting [Interrupt] to [ON].
- Images cannot be delivered by performing [Simultaneous image distribution] for devices that are using the Multi Live mode of “Wireless Manager ME”. The Multi Live mode is a mode in which the images of multiple computer screens are displayed on one device.

### Delivering/Deleting Images ([Simultaneous image distribution] / [Distribution image deletion])

---

- In some models, when the setting of [No signal auto off] is enabled in the device menu, the power supply to the device is turned off if the time set in [No signal auto off] has elapsed after [Simultaneous image distribution] or [Distribution image deletion] is performed even if the delivered image data is still being displayed. To use this function, disable the setting of [No signal auto off] in the device menu.
- When scheduling image delivery with a specified character font and exporting the setting of that device to another computer, if the font does not exist in the destination computer, the characters are displayed in the default font of the OS. The default font varies according to OS and language.
- In some models, after [Simultaneous image distribution] or [Distribution image deletion] has been performed, it may not be possible to set each item of [Image adjustment] and [Position adjustment] in the device menu.
- Images cannot be delivered by performing [Simultaneous image distribution] for devices in which the device network password is on (enabled). When the simultaneous image distribution function is used, turn off (disable) [Network] → [Password setting] in the device menu.

## Distributing image data to multiple devices

### ■ Configuration by specifying a date and time in [Schedule]

- 1 Select the icon for the desired device, group, or keyword from the tree pane of the <Device Monitoring> window, right-click it, and select [Schedule]. (page 122)
- 2 On the schedule setting screen, click [Schedule addition] or [Edit].
- 3 Specify the date and time, and select [Simultaneous image distribution].
  - Select [Specified Date], [Everyday], or [Weekly] (by day of the week) and then set [Time].

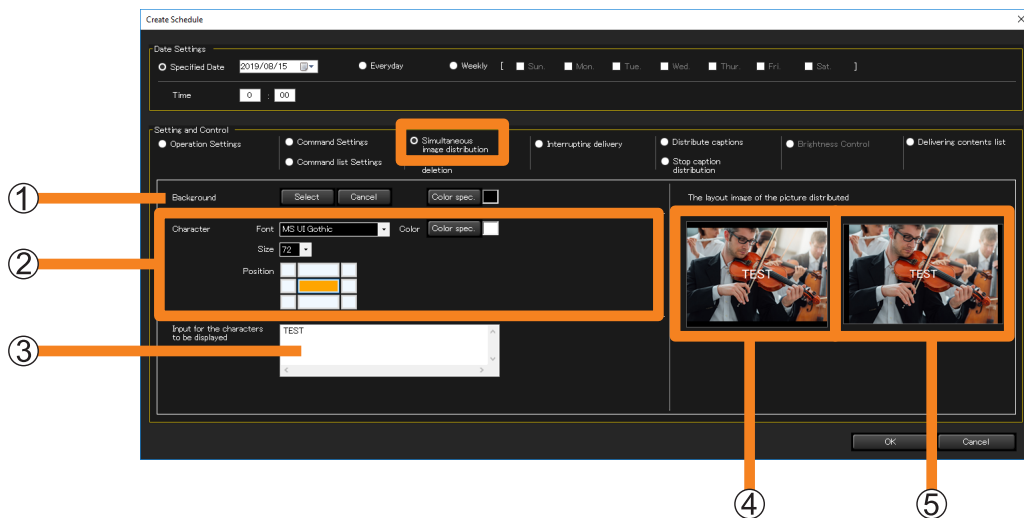

### 4 Select the image to be delivered and the background color. (①)

- [Select]:** The Image Select window appears. After you select an image to be delivered and click [OK], the image will be displayed in ④ and ⑤.
- [Cancel]:** Delete the image selected in [Select].
- [Color spec.]:** A color palette appears, and the selected color is set as the background color of the image.

- The images that can be delivered are as follows.
  - Extension: .jpg, .jpeg, .bmp
  - Image size: Not exceeding 4,096 pixels on the long edge or 2,160 pixels on the short edge
- If there is a blank in the display area when selected image is displayed on the device, the blank area will be displayed with the specified background color.
- Image delivery is possible even in the state in which just a background color has been set without performing image selection.

## Delivering/Deleting Images ([Simultaneous image distribution] / [Distribution image deletion])

**5 To place text on the image to be delivered, set the text style in ② and enter the text to be displayed in ③.**

**[Font]:** Set the text font.

**[Size]:** Set the text size. (10 point to 150 point)

**[Position]:** Specify the position where the text is to be displayed.  
(Maximum: 128 single-byte characters (64 double-byte characters))

**[Color]:** Select the text color from the color palette.

Example: When upper left is specified in [Position]

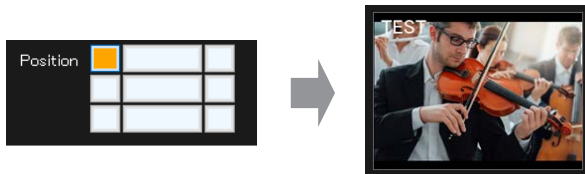

**6 Verify the results of your settings on the right side of the window under [The layout image of the picture distributed].**

④: Layout of the image on the screen when delivered to a device with a resolution aspect ratio of 4:3

⑤: Layout of the image on the screen when delivered to a device with a resolution aspect ratio of 16:10

- If the delivery destination is a device with a resolution aspect ratio of 4:3, the image (4:3) in ④ is delivered, and if it is a device 16:10, the wide image (16:10) in ⑤ is delivered.

**7 When you click [OK], the following message appears.**

If there is no problem switching to NETWORK or Panasonic APPLICATION input forcefully when the schedule is executed, apply the schedule by clicking [Yes]. If there is a problem, reset the schedule by clicking [No].

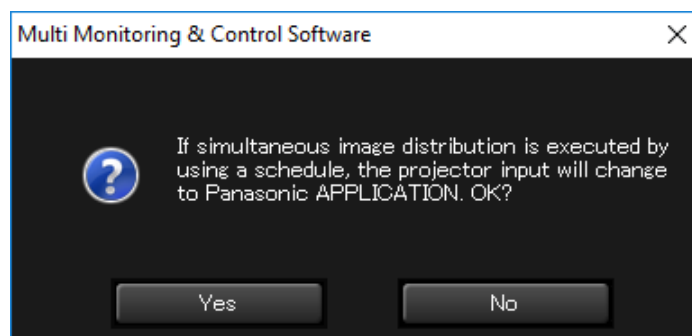

### Notes

- [The layout image of the picture distributed] is only for checking screen layout. The image is not guaranteed to exactly match the image displayed on the delivery destination screen.
- When the aspect setting of the device is changed, images might not be displayed with normal aspect.
- For details about setting the display aspect of a device, check the operation manual of the device you use.

## Delivering/Deleting Images ([Simultaneous image distribution] / [Distribution image deletion])

## ■ Executing directly from the menu

You can set [Simultaneous image distribution] directly from the menu without setting the execution date and time in the schedule.

- 1 From the tree pane of the <Device Monitoring> window, select the icon for the delivery target device, group, or keyword, right-click it, and select [Simultaneous image distribution].

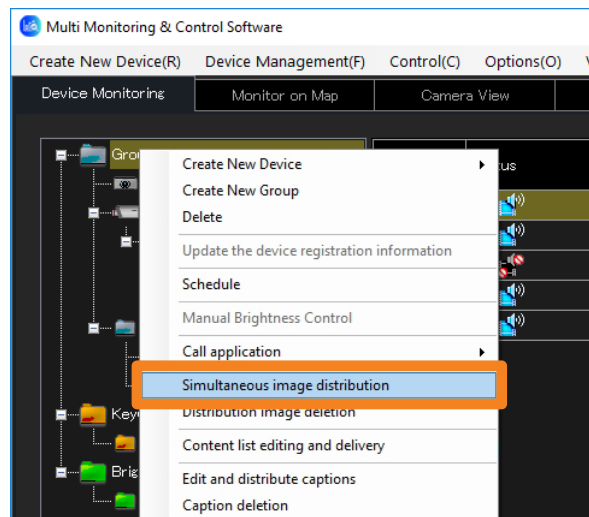

## 2 Configure the image to be delivered.

For how to configure the settings, see “Configuration by specifying a date and time in [Schedule]”. (page 132)

- When [Turn on the device power and distribute an image] (①) is checked, images are delivered after turning on the power of a device if the device is not turned on. (This operation is enabled only when devices are selected individually. This option cannot be set when a group, keyword, or brightness control is selected.)

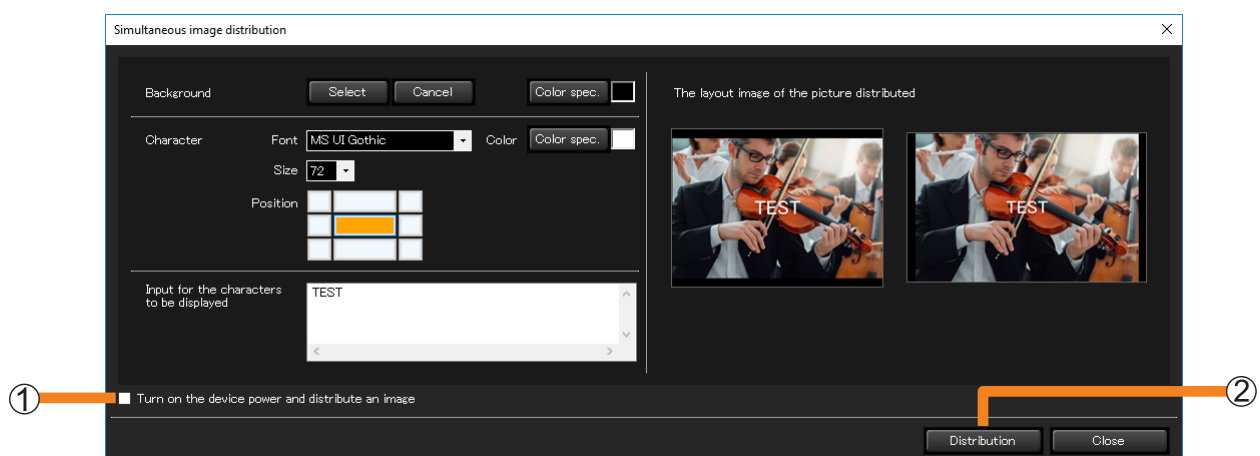

### Delivering/Deleting Images ([Simultaneous image distribution] / [Distribution image deletion])

---

#### **3** When you click [Distribution] (②), the following message appears.

If there is no problem switching to NETWORK or Panasonic APPLICATION input forcefully, execute the image delivery by clicking [Yes]. If there is a problem, cancel the image delivery by clicking [No].

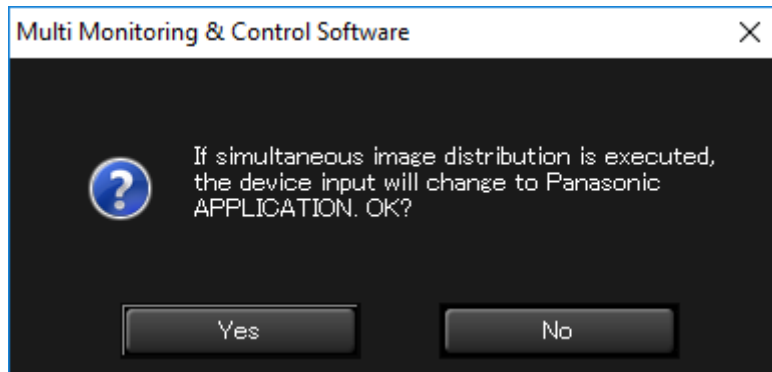

#### **Notes**

- When turning the projector on, take care to ensure that light from the light source cannot enter the eyes of people near the projector.
- If the power of the device unit is turned off or the connection with the unit is disconnected during delivery, the delivery will fail. Check the status of the connection with the unit and then execute delivery again.

## Deleting distribution images

### ■ Deletion by specifying a date and time in [Schedule]

- 1 Select the icon for the desired device, group, or keyword from the tree pane of the <Device Monitoring> window, right-click it, and select [Schedule]. (page 122)
- 2 On the schedule setting screen, click [Schedule addition] or [Edit].
- 3 Specify the date and time, and select [Distribution image deletion].
  - Select [Specified Date], [Everyday], or [Weekly] (by day of the week) and then set [Time].

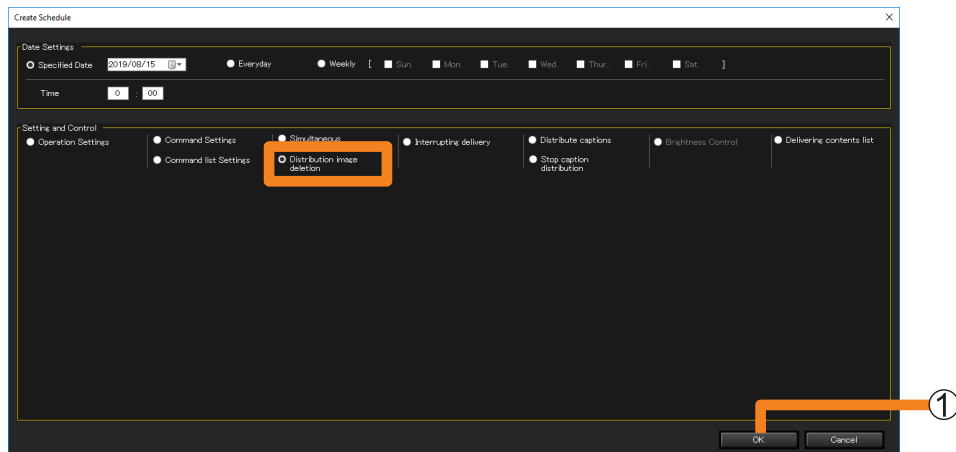

### 4 When you click [OK] (①), the following message appears.

Apply the schedule by clicking [Yes] if there is no problem switching to NETWORK or Panasonic APPLICATION input forcefully when the schedule is executed. If there is a problem, reset the schedule by clicking [No].

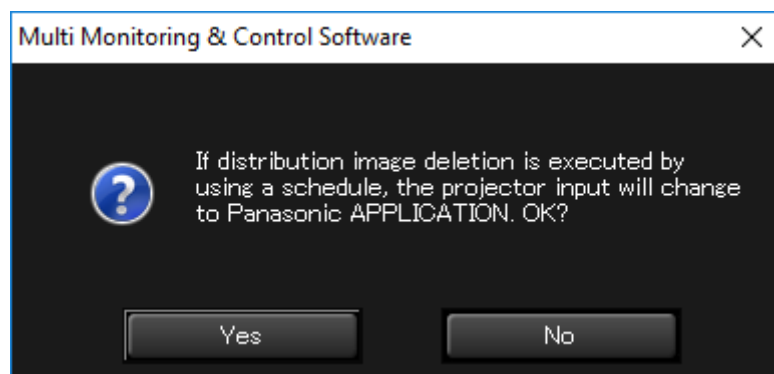



## Delivering/Deleting Images ([Simultaneous image distribution] / [Distribution image deletion])

## ■ Directly deleting from the menu

You can set [Distribution image deletion] directly from the menu without setting the execution date and time in the schedule.

- The Panasonic APPLICATION standby screen will appear. (Depending on the device, the screen may turn all black.)

**1** From the tree pane of the <Device Monitoring> window, select the icon for the delivery target device, group, or keyword, right-click it, and select [Distribution image deletion].

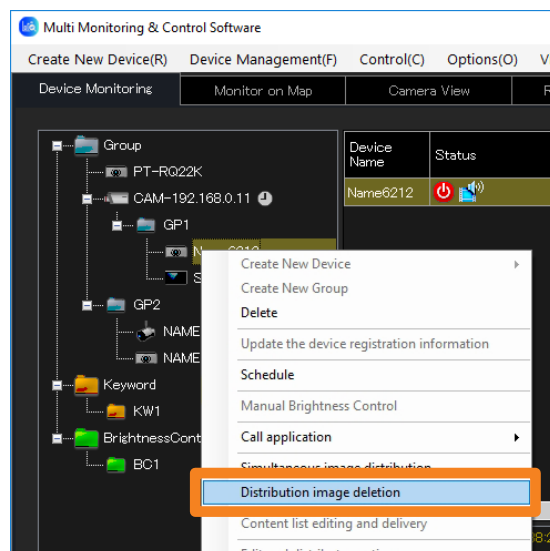

**2** The following message is displayed.

If there is no problem switching to NETWORK or Panasonic APPLICATION input forcefully, execute the deletion of the delivered image by clicking [Yes]. To cancel the deletion of the delivered image, click [No].

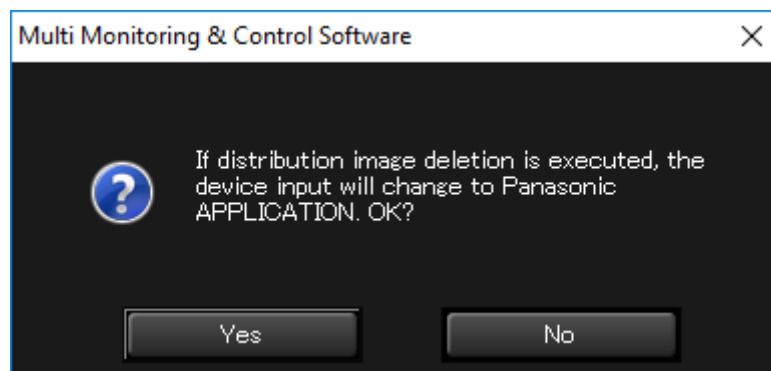

## Checking the image distribution/deletion execution status

When you execute [Simultaneous image distribution] or [Distribution image deletion], the setting status will be displayed under [Image distribution] in the Brief information display area.

- For details about the icons that are displayed, see page 81.

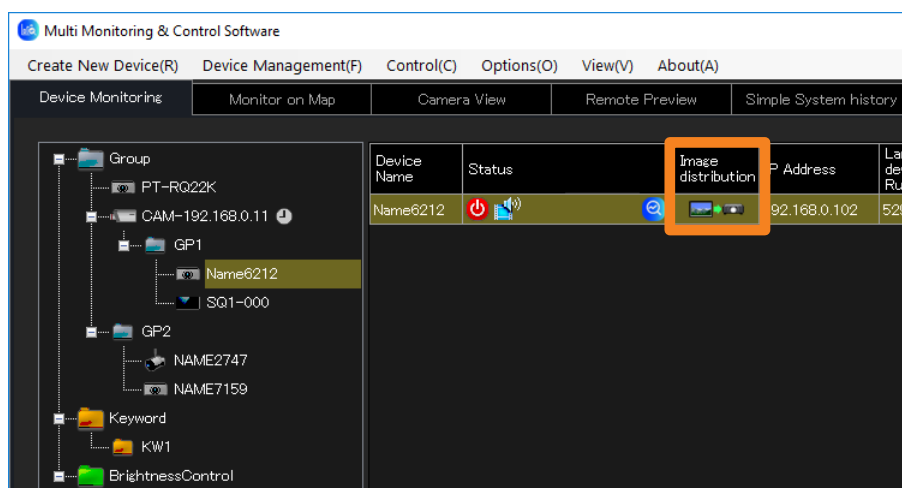

## Delivering Images by Interruption during Signage Playback (Interrupting delivery)

Separate content stored on a computer can be displayed on projectors during signage playback by specifying a time to interrupt playback. In addition, files stored on a computer can be copied to memory, such as SD memory cards, used by projectors.

### Notes

- To see if a device being used supports [Interrupting delivery], refer to the “List of Compatible Device Models” of this application software which is posted on the following website.  
<https://panasonic.net/cns/projector/download/application/>

## Types of content files that can be delivered

### Still images

Extension	Format	Restriction
jpg/jpeg	JPEG	Maximum number of pixels: 8,000 × 8,000 (For progressive JPEG, maximum is 4,096 × 4,096) YUV format: Only YUV444, YUV422, and YUV411 supported Color mode: Only RGB supported
bmp	Windows Bitmap	Maximum number of pixels: 2,000 × 2,000 (1, 4, 8, 16, 24, and 32 bit supported) Following formats are not supported. Run-length encoding, Bit fields, Top to bottom, Transparent data

### Movie

Extension	Codec		Restrictions <sup>*1</sup>	
	Video	Audio	Video	Audio
mov	H.264 / MPEG-4 AVC Motion JPEG	AAC Linear PCM	Resolution: Maximum 1,920 × 1,080 Minimum 240 × 180 Frame rate: Maximum 30 fps Bit rate: Maximum 40 Mbps	Sample rate: Maximum 48 kHz (For Linear PCM, maximum 16 kHz) Channel: Maximum 2 ch Bit rate: Maximum 384 kbps
avi	H.264 / MPEG-4 AVC Motion JPEG MPEG-4	MPEG-1/2 Audio Layer-3 (MP3) AAC Linear PCM		
mp4	H.264 / MPEG-4 AVC MPEG-4	AAC MPEG-4 AAC-LC		
mpg/mpeg	MPEG-2 <sup>*2</sup>	MPEG-1/2 Audio Layer-2		
wmv	WMV9	WMA		

\*1 Following movie files are not supported.

- Files with the video codec of WMV7, WMV8, DivX, or Xvid
- Uncompressed video
- Multi-angle video

• Files with the profile of Advanced Simple Profile @ Level 0 or Advanced Simple Profile @ Level 1

\*2 Only audio is played, and videos cannot be displayed in the preview window.

## Delivering Images by Interruption during Signage Playback ([Interrupting delivery])

### ■ Configuration by specifying a date and time in [Schedule]

- 1 Select the icon for the desired projector, group, or keyword from the tree pane of the <Device Monitoring> window, right-click it, and select [Schedule]. (page 122)
- 2 On the schedule setting screen, click [Schedule addition] or [Edit].
- 3 Specify the date and time, and select [Interrupting delivery].
  - Select [Specified Date], [Everyday], or [Weekly] (by day of the week) and then set [Time].

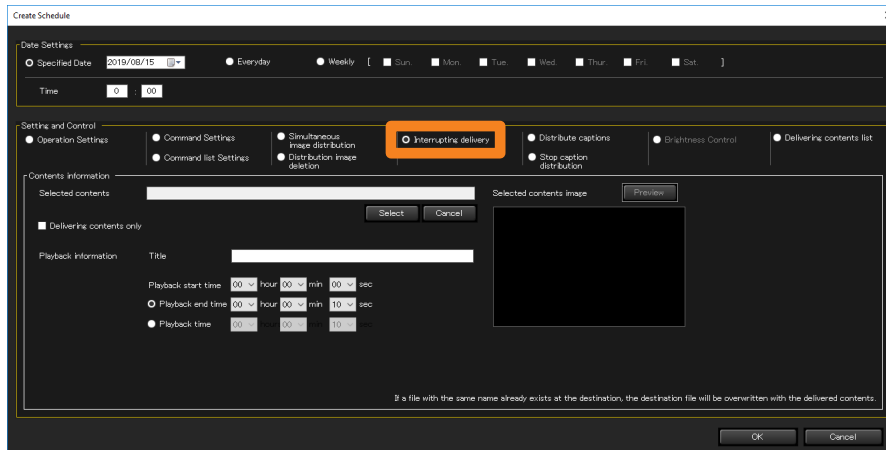

### 4 Click [Select] (①), then select an image for interrupt playback.

An image selection window will appear.

- When cancelling a selected image, click [Cancel] (②).
- When you click [OK] (③) after selecting an image, the selected image will be displayed in (④). For videos, when you click [Preview] (⑤), you can check the selected video.

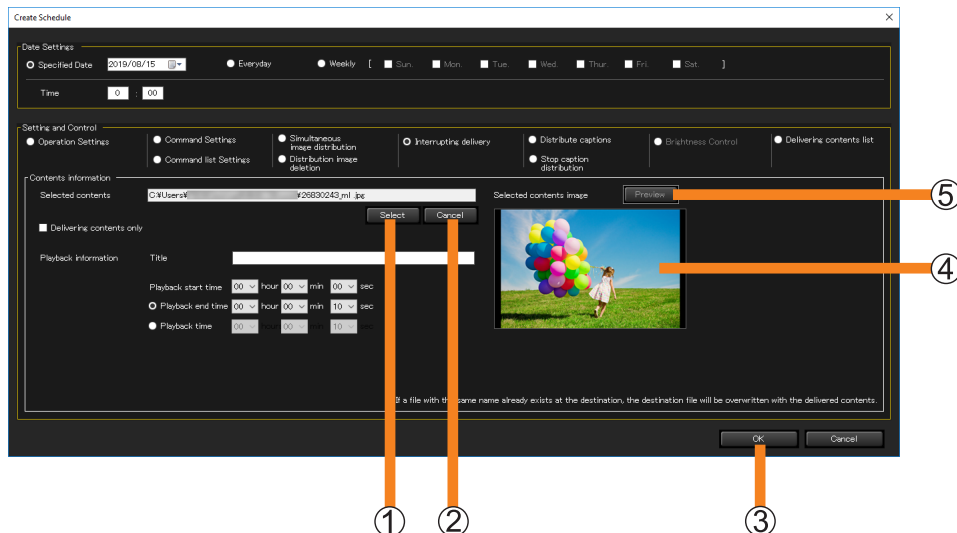

## Delivering Images by Interruption during Signage Playback ([Interrupting delivery])

**5 Set the playback method.****⑥ [Delivering contents only]:**

Select this check box to copy a file stored on the computer to an SD memory card or similar memory device inserted in the projectors. (If this box is checked, [Playback information] cannot be entered.)

**⑦ Enter [Playback information]:**

To specify interrupt playback of separate contents for projectors during signage playback, enter [Playback information] such as the playback start time, etc. Enter [Title], [Playback start time] and [Playback end time], or [Playback start time] and [Playback time] of the contents to deliver.

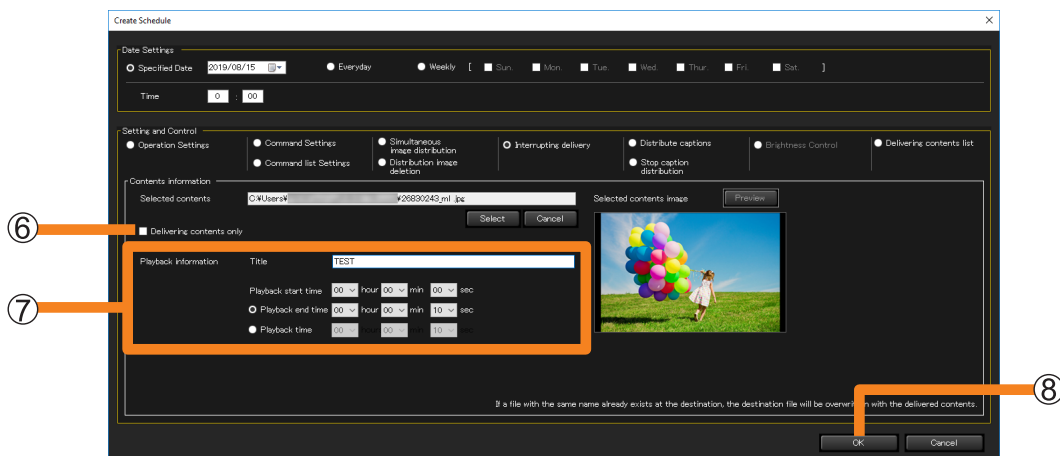

- Enter the name of the contents to deliver in [Title]. Up to 24 alphanumeric characters can be entered.
- To set the time, specify [Playback start time] and [Playback end time], or [Playback start time] and [Playback time]. Times between 00:00:10 and 24:00:00 can be specified.
- If a file with the same name as the contents for delivery already exists on the delivery destination, the destination file will be overwritten, even if the contents have a different name. In this case, the contents registered in the signage schedule will be replaced by the delivered contents.

**6 Click [OK] (⑧).**

## Delivering Images by Interruption during Signage Playback ([Interrupting delivery])

### ■ Configuration directly from the menu

You can set [Interrupting delivery] directly from the menu without setting the execution date and time in the schedule.

- 1 From the tree pane of the <Device Monitoring> window, select the icon for the delivery target projector, group, or keyword, right-click it, and select [Interrupting delivery].

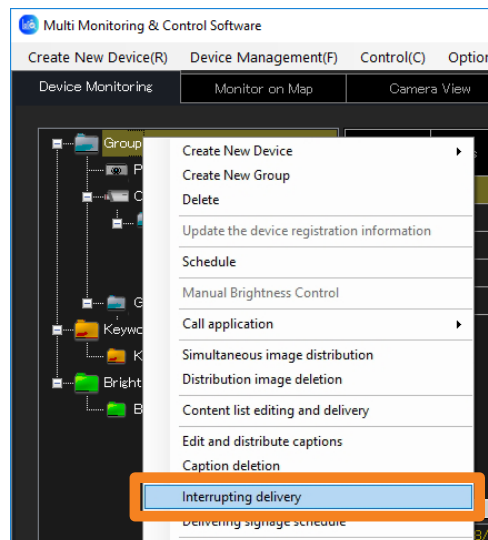

- 2 Select the image for interrupt playback and choose a playback method.

For how to configure the settings, see “Configuration by specifying a date and time in [Schedule]”. (page 140)



- 3 Click [Delivery] (①) to deliver the contents information.

The delivery progress status is displayed.

- 4 Click [Close] (②) to close the window.

### Notes

- It may take a while for delivery to complete depending on the sizes of the content files.
- If the power of the device unit is turned off or the connection with the unit is disconnected during delivery, the delivery will fail. Check the status of the connection with the unit and then execute delivery again.

## Caption distribution/stop

([Distribute captions]/ [Stop caption distribution])

- [Distribute captions]:** You can distribute a caption of your choice onto the specified position on the display to a flat panel display that is equipped with a caption playback function. (page 147)
- [Stop caption distribution]:** Delete a distributed caption. (page 149)

### Notes

- To see if the device you are using supports the caption playback function, refer to the “List of Compatible Device Models” of this application software which is posted on the following website.  
<https://panasonic.net/cns/prodisplays/download/software/>
- In some models, when the setting of [No signal auto off] is enabled in the device menu, the power supply to the device is turned off if the time set in [No signal auto off] has elapsed after [Distribute captions] or [Stop caption distribution] is performed even if the delivered image data is still being displayed. To use this function, disable the setting of [No signal auto off] in the device menu.
- When scheduling image delivery with a specified character font and exporting the setting of that device to another computer, if the font does not exist in the destination computer, the characters are displayed in the default font of the OS. The default font varies according to OS and language.
- Display a preview of the setting status of the caption distribution using the specified font. Preview display is a guide for operation check so it may differ from the caption display of the actual device.

## Create and edit a caption list.

**1** Select the icon for the desired device, group, or keyword from the tree pane of the <Device Monitoring> window, right-click it, and select [Edit and distribute captions].

- Alternatively, you can use the following method.
  - Display the schedule setting screen with Step 1 and 2 from page 122, and place a check on [Edit] or [Schedule Addition] → [Setting and Control] → [Distribute captions].

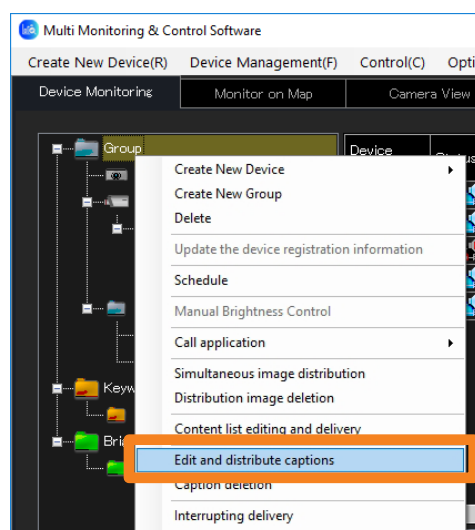

## Caption distribution/stop ([Distribute captions]/ [Stop caption distribution])

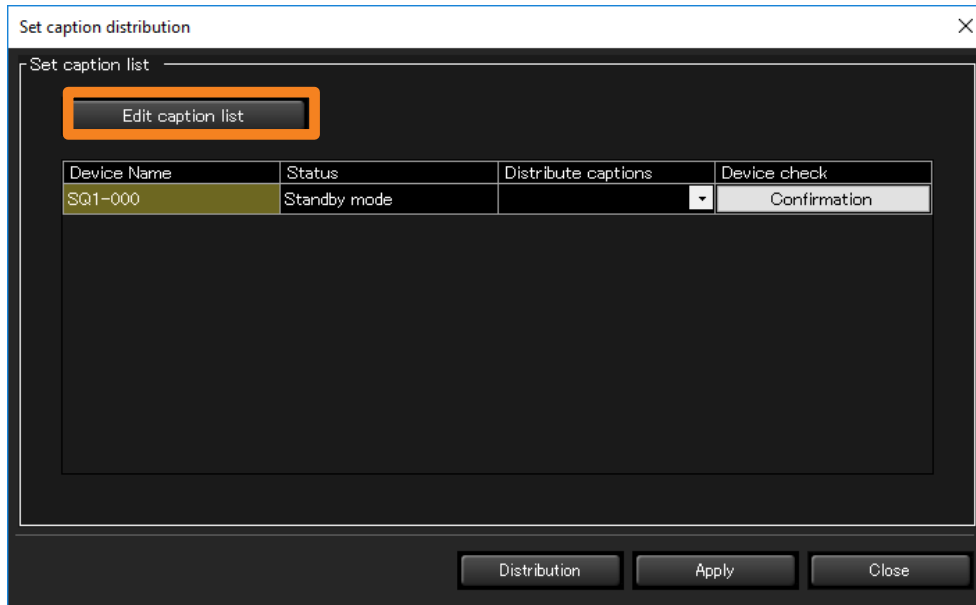
**2** Click [Edit caption list].**3** Select a caption to create or edit from [Caption list].

**[Caption list]:** To create new content, select a content that has not been created yet (or is no longer needed). To edit content, choose a list name you want to edit.

**[Change]:** When you click the selected List name after directly rewriting the name, the changed list name will be confirmed. Up to 32 alphanumeric characters can be entered.

**[Clear]:** The List name will return to its default state and the set content of the [Caption information] will be discarded.

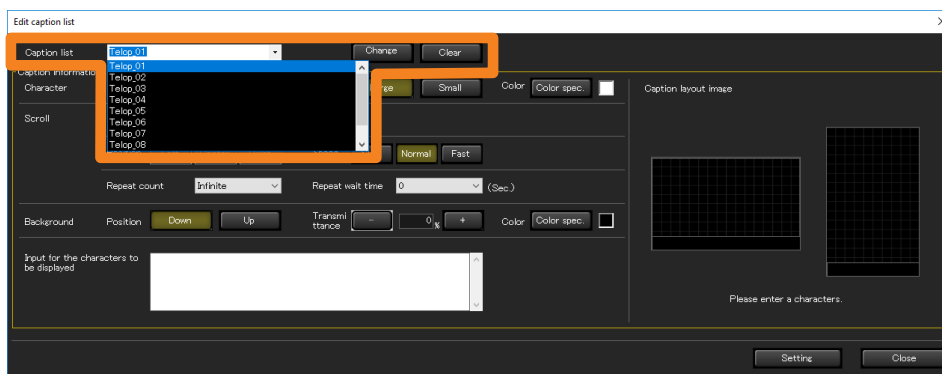





## Caption distribution/stop ([Distribute captions]/ [Stop caption distribution])

**8 Click [Setting] (5).**

The setting will be completed, and the list created will be displayed in [Distribute captions].

- Click [Setting] for each list. If you change the [List name] without pressing [Setting], the content set in [Caption information] will be discarded.
- If you click [Close] (6), the set content will be discarded and the setting screen will close.

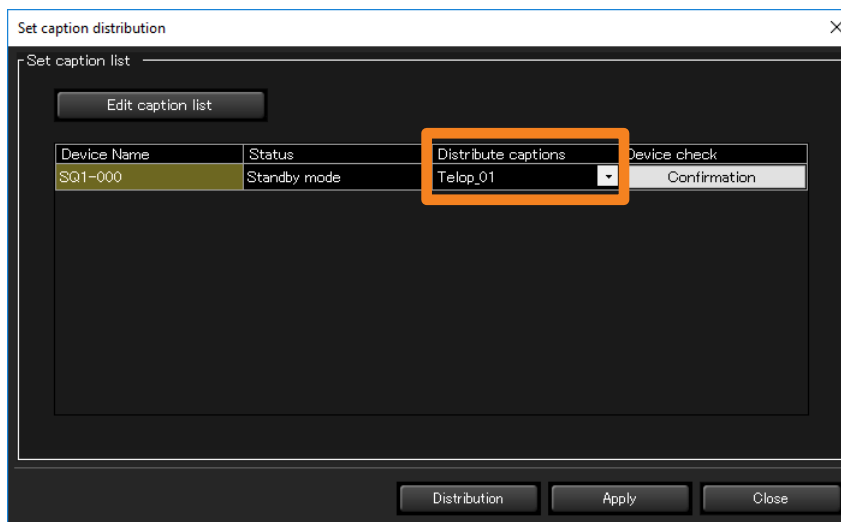

## Caption distribution/stop ([Distribute captions]/ [Stop caption distribution])

## Distribute the caption list

### Notes

- The caption list will not be distributed to devices not connected to the network during distribution.
- When caption list distribution is performed, the content set at [Device list setting] will automatically be saved.  
The next time the caption list distribution window is started, the automatically saved set content will be displayed.
- If the power of the device unit is turned off or the connection with the unit is disconnected during delivery, the delivery will fail. Check the status of the connection with the unit and then execute delivery again.

### ■ Configuration by specifying a date and time in [Schedule]

- 1** Select the icon for the desired projector, group, or keyword from the tree pane of the <Device Monitoring> window, right-click it, and select [Schedule]. (page 122)
- 2** On the schedule setting screen, click [Schedule addition] or [Edit].
- 3** Specify the date and time, and select [Distribute captions].
  - Select [Specified Date], [Everyday], or [Weekly] (by day of the week) and then set [Time].

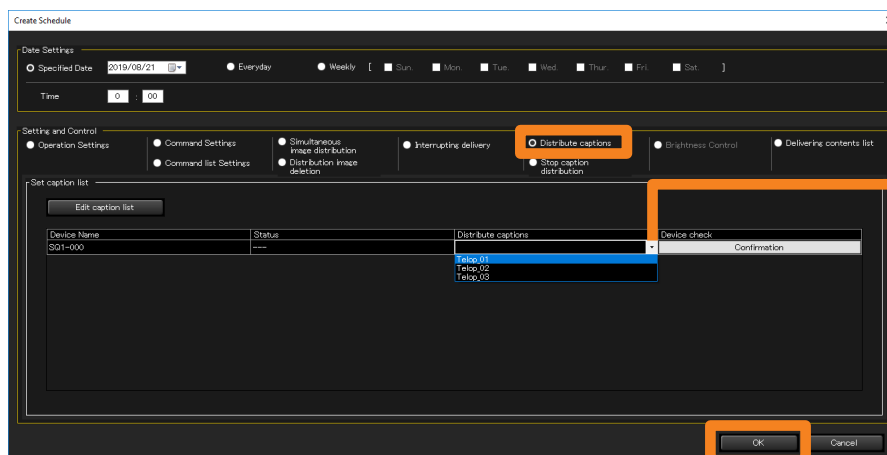

### 4 Select a list to distribute from [Distribute captions] (①).

- If a group or keyword icon is selected at Step 1, you can select a different list for each device.
- If nothing is displayed in the list, it is necessary to create a caption list. (page 143)

### 5 Click [OK].

The caption list distribution will be completed.

- After the setting is complete, leave the software running. If the software ends or the computer goes into sleep mode, caption list distribution will not be performed on the date and time set.

## Caption distribution/stop ([Distribute captions]/ [Stop caption distribution])

## ■ Configuration directly from the menu

- 1 From the tree pane of the <Device Monitoring> window, select the icon for a device, group, or keyword, right-click it, and select [Edit and distribute captions].

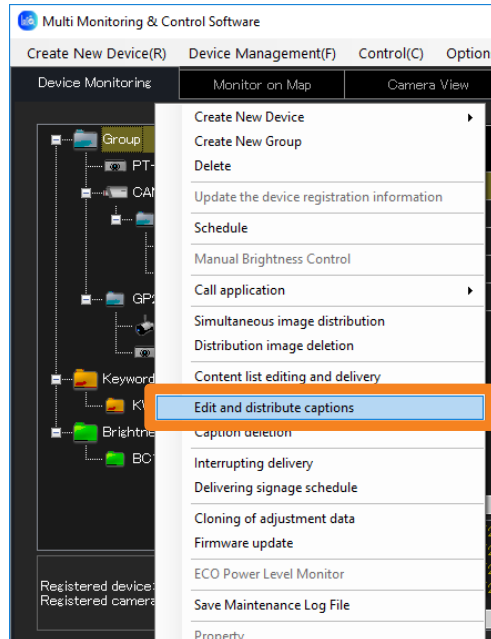

- 2 Select a list to distribute from [Distribute captions] (①).

- If a group or keyword icon is selected at Step 1, you can select a different list for each device.
- If nothing is displayed in the list, it is necessary to create a caption list. (page 143)

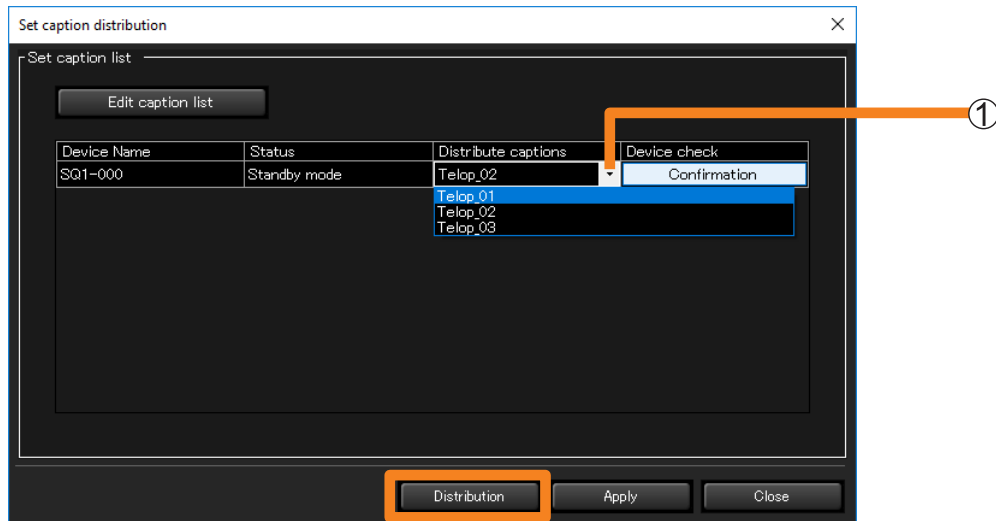

- 3 Click [Distribution].

The set content of the list will be sent to the device to be distributed via LAN and caption list distribution will be performed.

- To save the set content, click [Apply].

Caption distribution/stop ([Distribute captions]/ [Stop caption distribution])

## Deleting distributed captions

### ■ Deletion by specifying a date and time in [Schedule]

- 1** Select the icon for the desired projector, group, or keyword from the tree pane of the <Device Monitoring> window, right-click it, and select [Schedule]. (page 122)
- 2** On the schedule setting screen, click [Schedule addition] or [Edit].
- 3** Specify a date and time then select [Stop caption distribution].  
Select [Specified Date], [Everyday], or [Weekly] (by day of the week) and then set [Time].

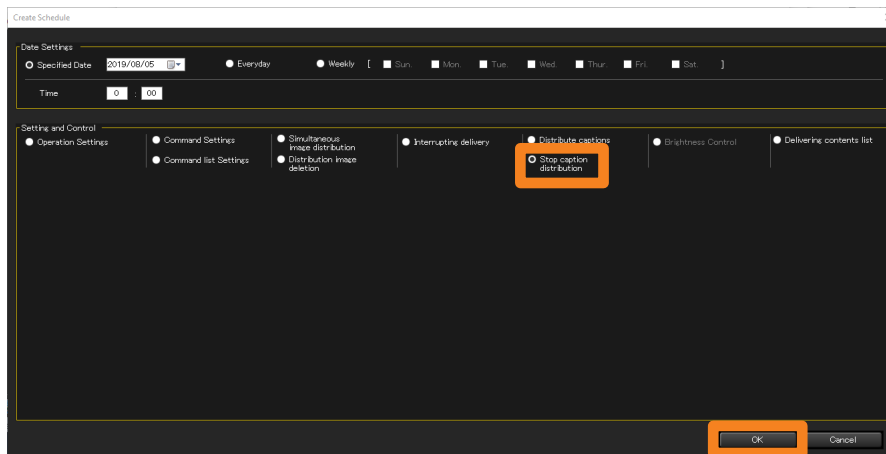

### **4** Click [OK].

Distribution settings will be deleted.

## Caption distribution/stop ([Distribute captions]/ [Stop caption distribution])

**■ Directly deleting from the menu**

Deleting captions being distributed, directly from the menu.

- 1** From the tree pane of the <Device Monitoring> window, select the icon for the delivery target device, group, or keyword, right-click it, and select [Caption deletion].

Distribution settings will be deleted.

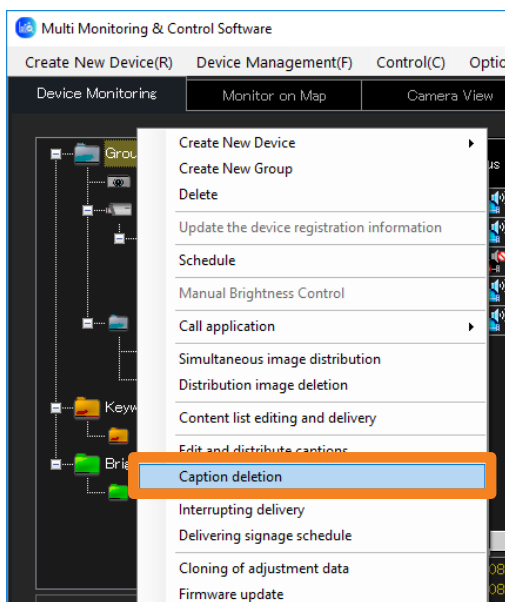

## Adjusting Brightness on a per-Screen Basis

([Brightness Control])

When multiple projectors equipped with the brightness control function is used to project an integrated image, the function automatically controls the projectors so that the brightness between the projected images from each of the projectors are held uniform.

- Brightness control is a function to help you maintain the brightness of multiple projectors at a uniform level. It does not guarantee that the brightness of all projectors will completely match.

### Notes

- To see if a device being used supports [Brightness Control], refer to the “List of Compatible Device Models” of this application software which is posted on the following website.  
<https://panasonic.net/cns/projector/download/application/>

### An illustration of brightness control

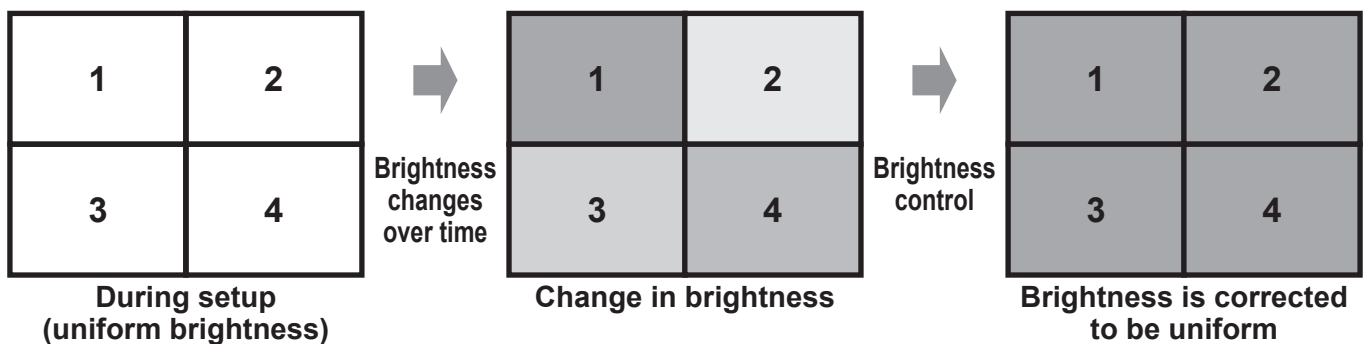

## Projector settings

Configure the following settings from the on-screen menu of each projector.

- 1 Adjust the gain value so that the brightness of the projectors match.**
- 2 Go to [MAIN MENU] → [PROJECTOR SETUP] → [Brightness Control] → [Brightness Control Setting], and set the [Mode] (or [Fixed Mode]) to [PC].**

### Notes

- For how to adjust the brightness of the projector, please refer to the operating manual for the projector being used.

## Adjusting Brightness on a per-Screen Basis ([Brightness Control])

### ■ Execution by specifying a date and time in [Schedule]

- 1 From the tree pane of the <Device Monitoring> window, select the icon for the brightness control whose schedule is to be set, right-click it, and select [Schedule]. (page 122)
- 2 On the schedule setting screen, click [Schedule addition] or [Edit].
- 3 Specify the date and time, and select [Brightness Control].
  - Select [Specified Date], [Everyday], or [Weekly] (by day of the week) and then set [Time].

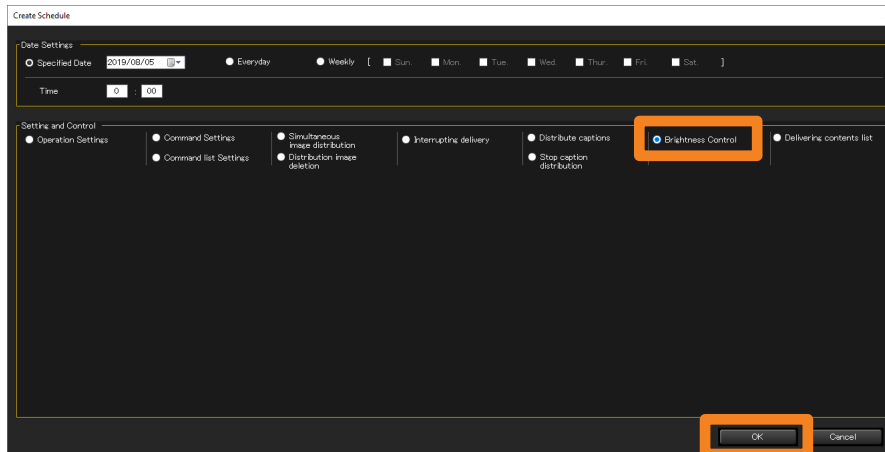

- 4 Click [OK] to end the setting.

### ■ Executing directly from the menu

You can set [Brightness Control] directly from the menu without setting the execution date and time in the schedule.

- 1 From the tree pane of the <Device Monitoring> window, select a brightness control icon, right-click it, and select [Manual Brightness Control].

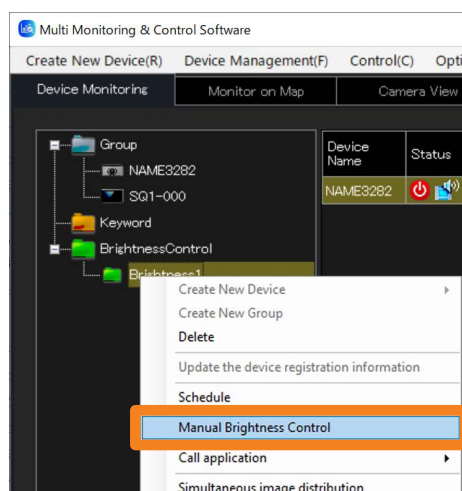



## Adjusting Brightness on a per-Screen Basis ([Brightness Control])

**Checking the progress status of brightness control**

When the brightness control is executed, the status bar at the bottom of the screen changes from [Ready] to [Brightness Control is being executed.] and a progress bar appears on the right side. When the display returns to [Ready], it means that brightness control execution has completed.

- If brightness control is not successful, a warning icon is displayed next to the brightness control icon on the tree pane of the <Device Monitoring> window.

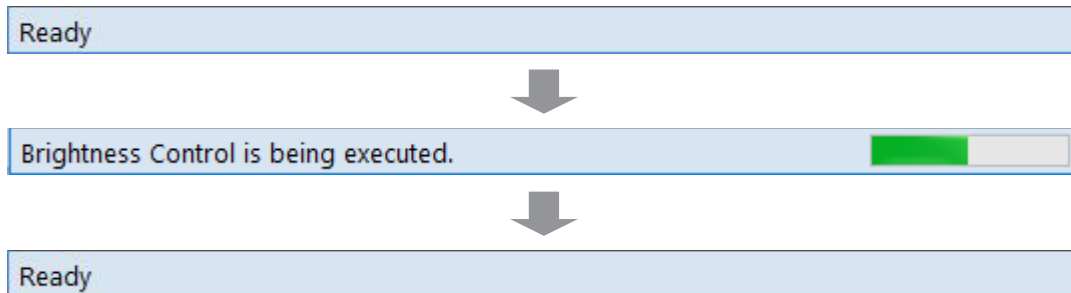
**Notes**

- Brightness control may not be successful when the projector is in the following states. Check the projector status before attempting brightness control again.
  - A projector is undergoing lamp relay.
  - A projector is in standby mode (it is turned off)
  - The computer cannot connect to a projector (e.g. poor LAN cable connection)

## Creating a List to Distribute Images ([Delivering contents list])

The content list delivery function delivers content (still images and movies) that can be played with a USB media player or Scenario playback function, together with the corresponding play list for the content. The content must be delivered to a flat panel display equipped with the USB media player function or a projector equipped with the “Scenario” playback function in its “Memory Viewer” function.

### Notes

- To use the content list delivery function, you need to insert a formatted USB memory device into the device unit. For details on the specifications of USB memory devices that can be used, refer to the instruction manual for your device.
- When you use the content list delivery function, the delivered content list (content and play list) is written to the USB memory device inserted in the device unit. If there is already content or a play list with the same file name in the delivery destination USB memory device, it will be overwritten regardless of the write-protect setting.
- Even if content is directly saved to the USB memory device after delivering the content and play list using the content list delivery function, that content will not be played as it is not registered in the play list.
- To see if the device being used supports [Delivering contents list], refer to the “List of Compatible Device Models” of this application software which is posted on the following website.  
<https://panasonic.net/cns/projector/download/application/>  
<https://panasonic.net/cns/prodisplays/download/software/>
- For details on portrait settings, refer to the instruction manual for your flat-panel display.
- For details on the USB media player function, refer to the instruction manual for your flat panel display.
- For details on the Memory Viewer Scenario playback function, refer to the instruction manual for your projector.

## Creating a List to Distribute Images ([Delivering contents list])

## ■ Types of content files that can be delivered

## Still images

○: Support    ×: Not support

Extension	Format	Restrictions <sup>*1</sup>	Projector	Flat panel display
jpg jpeg	JPEG	Maximum number of pixels: 4,096 × 4,096	○	○
jpe		YUV format: Only YUV444 and YUV422 supported Color mode: Only RGB supported	×	○
bmp	Bitmap	Maximum number of pixels: 2,000 × 2,000 Color bit depth: 1, 4, 8, 16, 24, 32 bits supported	○	×

## Movie

Extension	Codec		Restrictions <sup>*2</sup>		Projector	Flat panel display
	Video	Audio	Video	Audio		
mov	H.264	AAC, HE-AAC Linear PCM	Resolution: Maximum 1,920(W)×1,080(H) (For 4K compatible flat panel displays, the maximum resolution is 3,840(W) × 2,160(H)) Frame rate: Maximum 30 fps (For 4K compatible flat panel displays, the frame rate is up to 60 fps <sup>*3</sup> ) Bit rate: Maximum 40 Mbps (For 4K compatible flat panel displays, the bit rate is up to 80 Mbps <sup>*3</sup> )	Sample rate: Maximum 48 kHz (Maximum 16 kHz for Linear PCM) Channel: Maximum 2 ch Bit rate: Maximum 384 kbps	○	○
avi	H.264, MPEG4 part2	MPEG1 Layer2 Linear PCM			○	○
mp4	H.264, MPEG4 part2	AAC			○	○
ts mts	H.264, MPEG4 part2	MP3 MPEG1 Layer2 HE-AAC			×	○
wmv	WMV9 VC-1 Simple & Main	WMA Standard WMA9/10 Pro			○	○
asf	H.264, MPEG4 part2 VC-1 Advanced AP@L3 VC-1 Simple & Main	WMA Standard WMA9/10 Pro			×	○
3gp	H.264, MPEG4 part2	AACHE-AAC			×	○
mkv	H.264, MPEG4 part2	MPEG1 Layer2 HE-AAC			×	○
flv f4v	H.264	MP3 AAC Linear PCM			×	○
mpg mpeg	MPEG2	MPEG1Layer2			○	×

\*1 Progressive JPG is not supported.

\*2 Following movie files are not supported.

- Multi-angle video
- Files with the profile of Advanced Simple Profile @ Level 0 or Advanced Simple Profile @ Level 1

\*3 Depending on the type of codec, playback may not be possible even if it is within the numerical values of restrictions.

## Creating a List to Distribute Images ([Delivering contents list])

## Creating and editing content lists

**1** Select the icon for the desired device, group, or keyword from the tree pane of the <Device Monitoring> window, right-click it, and select [Content list editing and delivery].

- Alternatively, you can use the following method.
  - Display the schedule setting screen with Step **1** and **2** from page 122, and place a check on [Edit] or [Schedule Addition] → [Setting and Control] → [Delivering contents list].

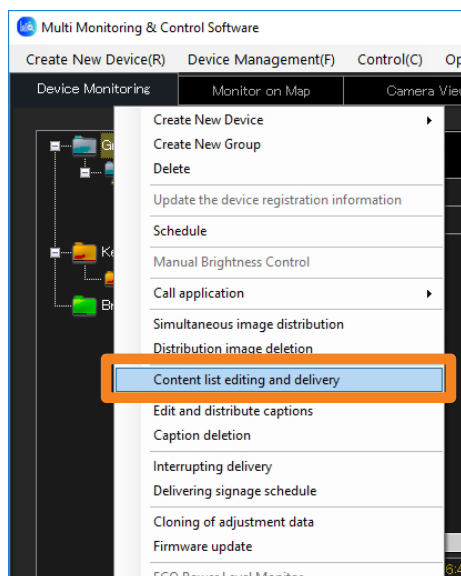

**2** Click [Content list editing].

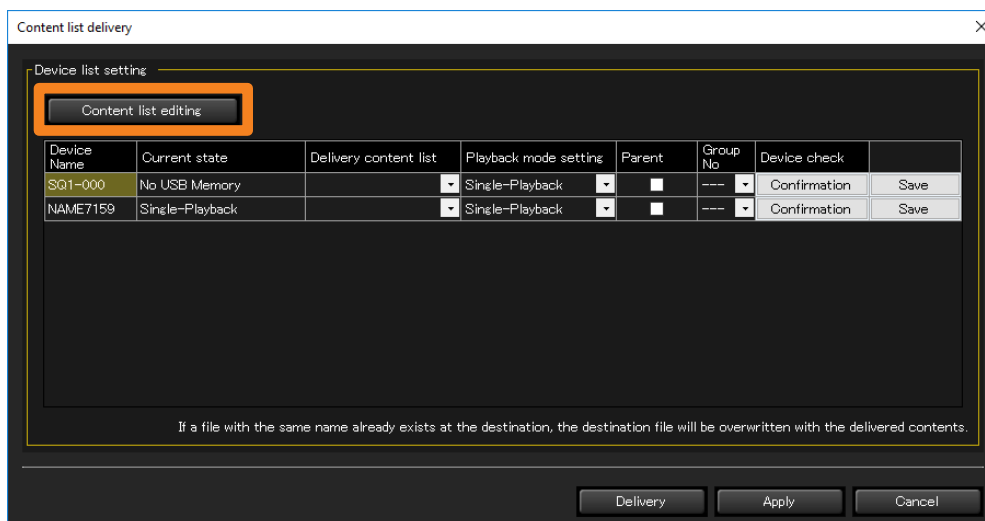

## Creating a List to Distribute Images ([Delivering contents list])

### 3 Select the content list to be created or edited from the [List name] pull-down menu.

- [List name]:** To create new content, select a content that has not been created yet. To edit content, choose a list name you want to edit.
- [Change]:** When you click the selected [List name] after directly rewriting the name, the changed list name will be confirmed. Up to 32 alphanumeric characters can be entered.
- [Clear]:** The [List name] will return to its default state and the set content of the [Play List] will be discarded.

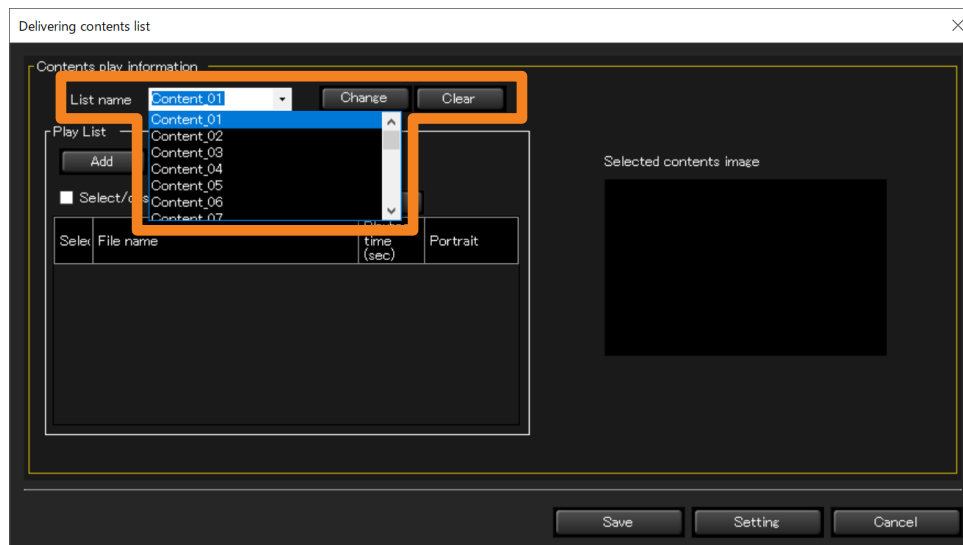

### 4 Click [Add] and select the content to be played back.

The file selection window appears. Select the content file to register to the play list and then click [Open]. (Multiple files can be selected by clicking them while pressing the Shift key or Ctrl key.)

- If the selected file is a still image, the image is displayed in ①. If it is a movie, an icon representing the movie is displayed in ①.
- The selected file name will appear in [Play List].

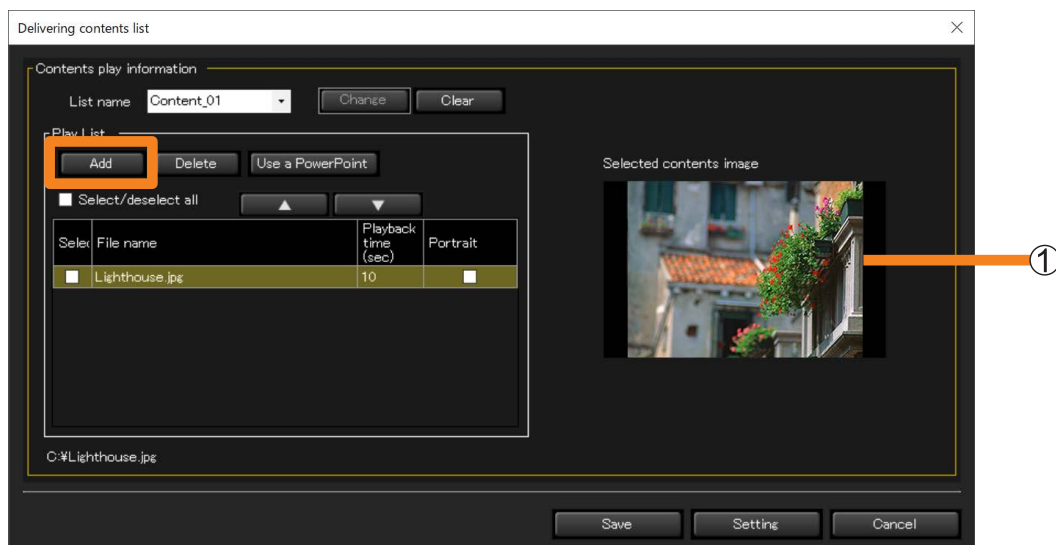

## Creating a List to Distribute Images ([Delivering contents list])

**5 Click [▲] / [▼] to specify the content playback sequence.**

- The files displayed in [Play List] are played in order from top to bottom on the USB media player or Memory Viewer.
- To delete a file from [Play List], select the [Select] check box for the file you wish to delete and then click [Delete].

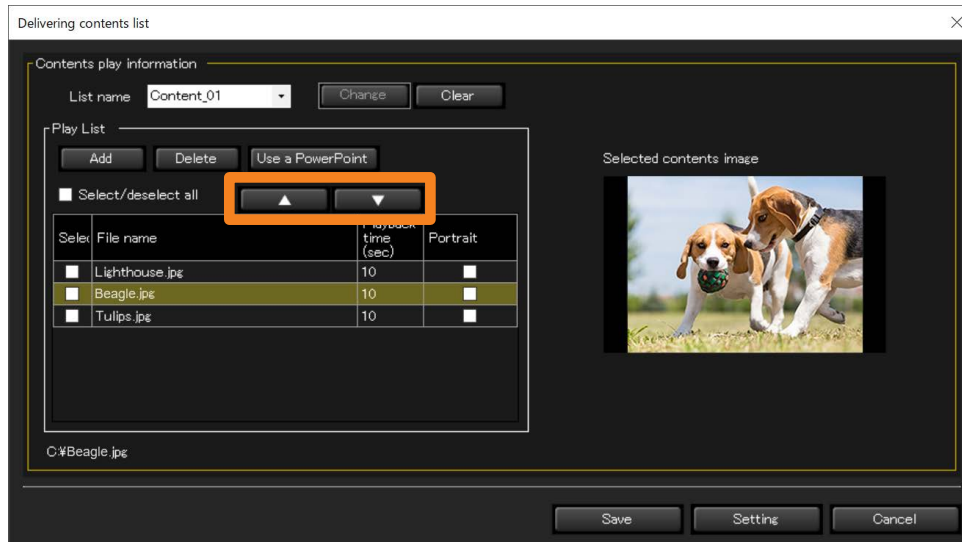
**6 Enter the playback duration for each content file under [Playback time (sec)] in the [Play list].**

- A playback time within the range of 3 to 86,400 seconds (equivalent to 24 hours) can be set.
- In the case of a still image, the default value is 10 seconds. In the case of a movie, the playback time of the selected movie file is the initial value. The playback time may not be acquired for some of the selected movie files. If the playback time cannot be acquired, the default playback time is 10 seconds.

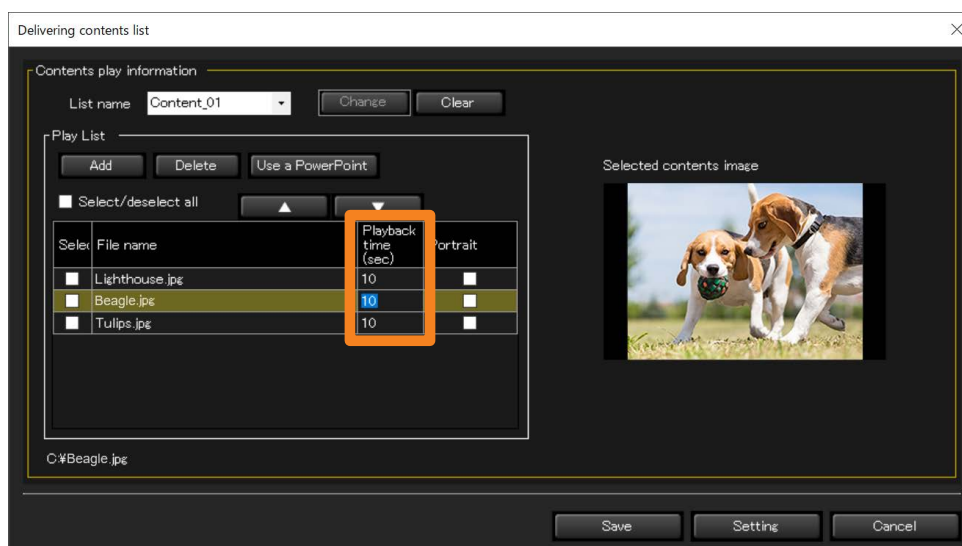

## Creating a List to Distribute Images ([Delivering contents list])

**7 (Projector)**

Proceed to step 8.

(Flat-panel display)

**Place a check on the content you want to display in portrait.**

When you place a check, the message [When the single playback mode is selected, the portrait setting is disabled.] is displayed.

- When you place a check, it is associated with the “Portrait settings” set with the device.

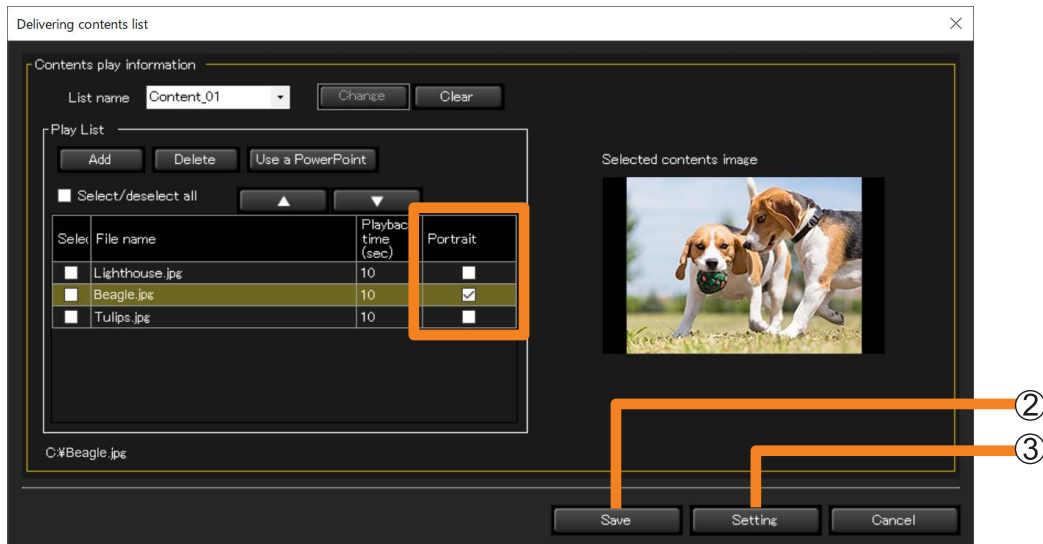
**8 Perform saving and setting.**

([Save])

You can save it in a desired location, such as your computer or external memory. You can also use saved content lists in a USB memory by directly inserting the USB memory into the device.

- 1 Click [Save] (2).
- 2 Select a playback mode and click [Save].

**[Single playback]:** Select when performing playback on a single device.

- When [Single playback] is selected, portrait display will not be performed even if a check is placed at step 7.

**[Multi playback]:** Select when performing synchronized playback on multiple devices.

([Parent] : Place a check when the set device will be considered as the parent.)

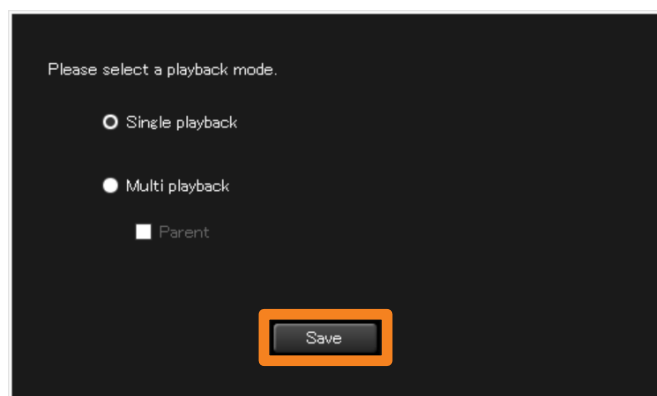

## Creating a List to Distribute Images ([Delivering contents list])

- ③ **Specify a save destination and click [OK].**  
Returns to the screen of step ① (page 159).

### ([Setting])

The created [Play List] will be saved in the software.

- ① **Click [Setting] (③).**

The setting will be completed, and the list created will be displayed in [Delivery content list].

- When you change the [List name] or close the screen without clicking [Setting], the content set at [Play List] is discarded.

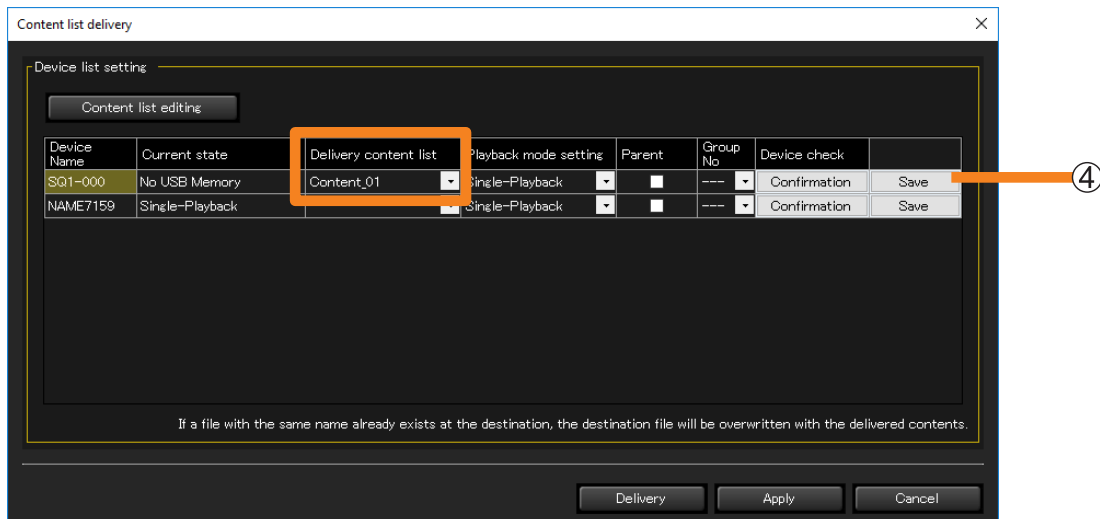

- When you click [Save] (④), you can perform the same operation with step ⑧ ([Save]) with each list. (page 159)

### Notes

- For contents checked in [Portrait], a “P” is added to the end of the corresponding line of the exported “File list (filelist.dat)” when saving the list.
- If [Multi playback] is selected when saving, make sure to check [Parent] for one device and set it as the parent. (The device set as the [Parent] should only be one device within the same group number) When the device set as the parent begins to play, the other devices (sub device) within the same group number will also begin to play.
- If [Multi playback] is selected when saving, the group number used to classify the network is fixed to “G01”. To change the group number, it is necessary to directly rewrite the “File list (filelist.dat)” that is exported when the content list is saved.
- For details on the saved file, see ③ of step ⑤ in “Configuration directly from the menu”. (page 166)



## Creating a List to Distribute Images ([Delivering contents list])

### ■ Using Files Created with PowerPoint for Delivery

A file created in PowerPoint can be converted to still images or a movie and then delivered as content.

- When a file created in PowerPoint is converted to still images or a movie, conversion may take a while depending on the animation effects and number of slides.

#### Preparation:

- Make sure Microsoft PowerPoint is installed on your computer.
- Supported versions: Microsoft PowerPoint 2010/2013

#### 1 Click [Content list editing].

Display the screen with the methods below. (The same with Step 1 of page 156)

- From the <Device Monitoring> window, select the icon for a device, group, or keyword then right-click it and select [Content list editing and delivery].
- Display the schedule setting screen with Step 1 and 2 from page 122, and place a check on [Edit] or [Schedule Addition] → [Setting and Control] → [Delivering contents list].

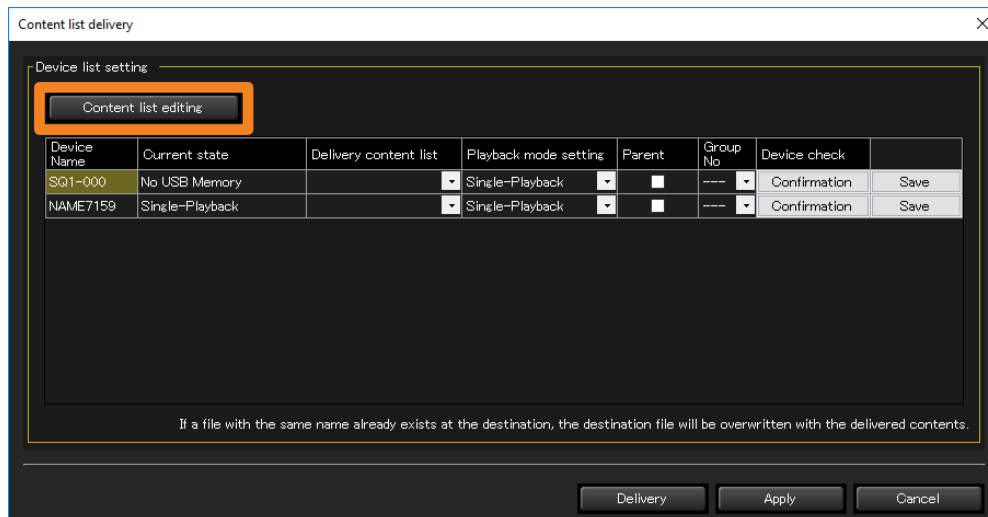

#### 2 Click [Use a PowerPoint].

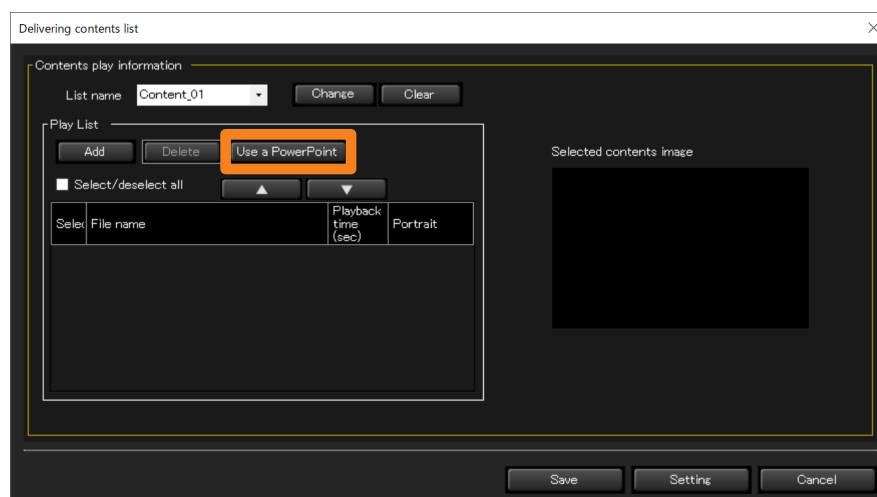

## Creating a List to Distribute Images ([Delivering contents list])

### 3 Click [Select], and select the PowerPoint file.

The first image of the selected PowerPoint slide is displayed in ①.

- If you select [New/Edit] (②) after selecting a file, the selected file will open in PowerPoint.
- If you select [New/Edit] (②) before selecting a file, you can create a new file.

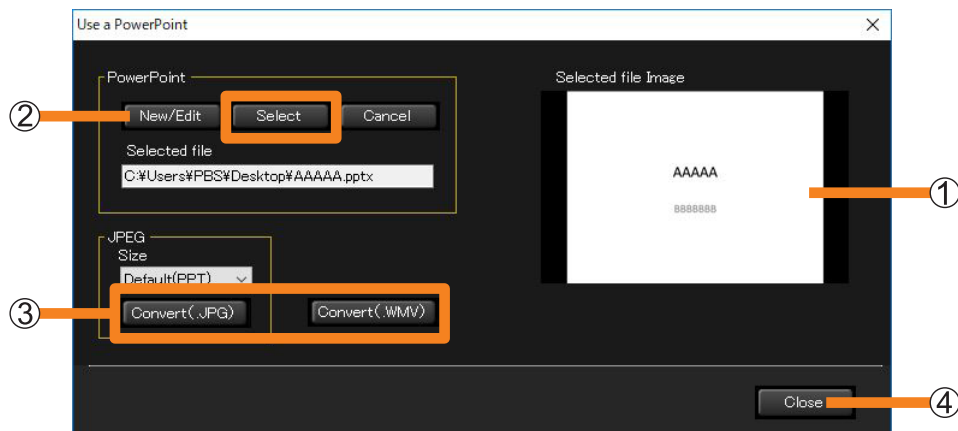

### 4 Click (③) [Convert(.JPG)] or [Convert(.WMV)].

The selected file is converted to a still image (JPG) or movie (WMV), and a completion message is displayed.

- When a file is converted to still images, settings such as animation effects are discarded.
- Conversion to a still image can be done at the resolution selected in [Size]. When [Default (PPT)] is selected, the image will be converted according to the configuration of your PowerPoint presentation tool.
- When a file is converted to a movie, conversion may take a while depending on the animation effects, number of slides, and other settings.

### 5 Click [Close] (④) and return to the screen of step 2.

The power point file selected will be displayed in [Play List].

### 6 Set the playback order, playback time, and portrait, then click [Setting].

For more details, see steps 5 to 8 of "Creating and editing content lists". (page 158)

## Creating a List to Distribute Images ([Delivering contents list])

## Delivering a content list

### Execution by specifying a date and time in [Schedule]

- 1 From the tree pane of the <Device Monitoring> window, select the icon for a device, group, or keyword, right-click it, and select [Schedule]. (page 122)
- 2 On the schedule setting screen, click [Schedule addition] or [Edit].
- 3 Specify the date and time, and select [Delivering contents list].
  - Select [Specified Date], [Everyday], or [Weekly] (by day of the week) and then set [Time].

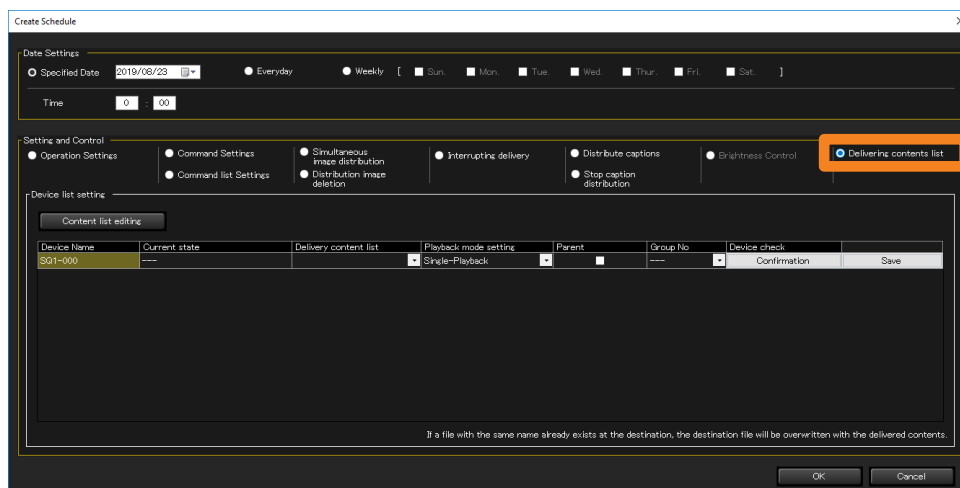

### 4 Select the list to be delivered from the [Delivery content list] (①).

- When a group or keyword icon is selected in step 1, different lists can be selected for each device.
- If nothing appears in the pull-down lists, it means content lists need to be created. (page 156)

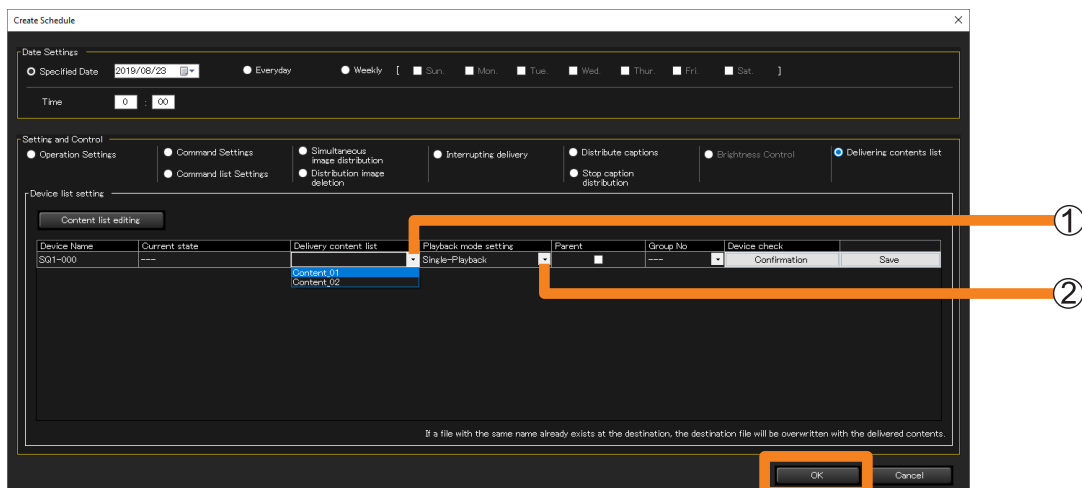

## Creating a List to Distribute Images ([Delivering contents list])

---

### 5 Select the [Playback mode setting] (②).

- [Single-Playback]:** For playback on a single projector or a single flat panel display
- [Multi-Playback]:** For starting playback simultaneously on multiple flat panel displays
- If the delivery target device is a projector, you cannot select [Multi-Playback].

### 6 If you selected [Multi-Playback] in step 5, set the [Parent] and [Group No].

- The [Group No] setting is identical to the group ID used to classify networks when using USB media players in Multi Media Player mode.
- You must also specify one flat panel display within the group as the Parent. When USB media player playback on the flat panel display specified as the Parent (primary display) starts, USB media player playback on the other flat panel displays in the same group (sub displays) also starts.
- If another flat panel display on the same network and with the same group ID is already specified as the primary display, [Parent] cannot be specified.
- To view the content that will be delivered, click [Confirmation]. The input signal, display mode (aspect ratio), and other information will be displayed on the corresponding flat panel display.

### 7 Click [OK].

Clicking [OK] will complete the content list delivery setting.

- After the setting is complete, leave the software running. If the software is exited or the computer enters the sleep state, content list delivery will not be performed on the set date and time.

#### Notes

- It may take a while for delivery to complete after it is started depending on the sizes of the content files.
- The content list is not delivered to any device that is not connected to the network at the time of delivery.
- The functions set in "POWER MANAGEMENT SETTINGS" of the flat panel display are disabled during content list delivery.
- If a flat panel display that is a delivery target is playing existing content with the USB media player, playback stops simultaneously with the start of content list delivery and then resumes with the new content after delivery completes.
- If the delivery target projector is playing back an existing scenario in Memory Viewer, playback stops simultaneously with the start of content list delivery and then resumes with the new scenario after delivery completes.
- When content list delivery is executed, the settings specified in [Device list setting] are automatically saved. The automatically saved settings will appear in the <Content list delivery> window the next time you open it.
- If the power of the device unit is turned off or the connection with the unit is disconnected during delivery, the delivery will fail. Check the status of the connection with the unit and then execute delivery again.

Creating a List to Distribute Images ([Delivering contents list])

■ Configuration directly from the menu

1 From the tree pane of the <Device Monitoring> window, select the icon for a device, group, or keyword, right-click it, and select [Content list editing and delivery].

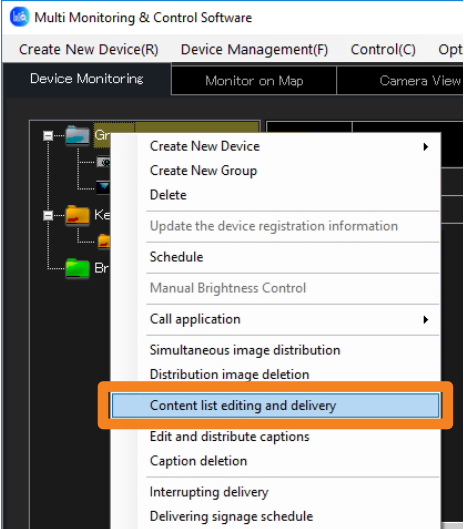

2 Select the list to be delivered from the [Delivery content list].

- When a group or keyword icon is selected in step 1, different lists can be selected for each device.
- If nothing appears in the pull-down lists, it means content lists need to be created. (page 156)

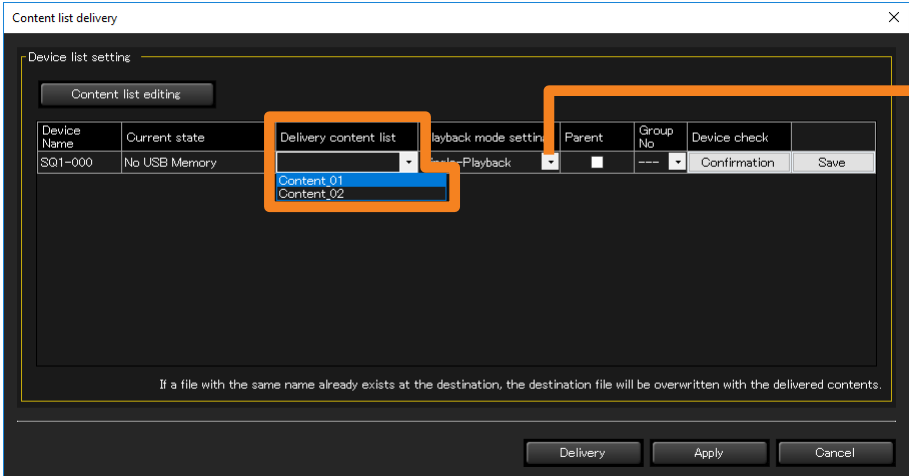

3 Select the [Playback mode setting] (1).

[Single-Playback]:

For playback on a single projector or a single flat panel display

[Multi-Playback]:

For starting playback simultaneously on multiple flat panel displays

- If the delivery target device is a projector, you cannot select [Multi-Playback].

## Creating a List to Distribute Images ([Delivering contents list])

### 4 If you selected [Multi-Playback] in step 3, set the [Parent] and [Group No].

- The [Group No] setting is identical to the group ID used to classify networks when using USB media players in Multi Media Player mode.
- You must also specify one flat panel display within the group as the Parent.
- If another flat panel display on the same network and with the same group ID is already specified as the primary display, [Parent] cannot be specified.
- To view the content that will be delivered, click [Confirmation]. The input signal, display mode (aspect ratio), and other information will be displayed on the corresponding flat panel display.

### 5 Deliver or save the content list.

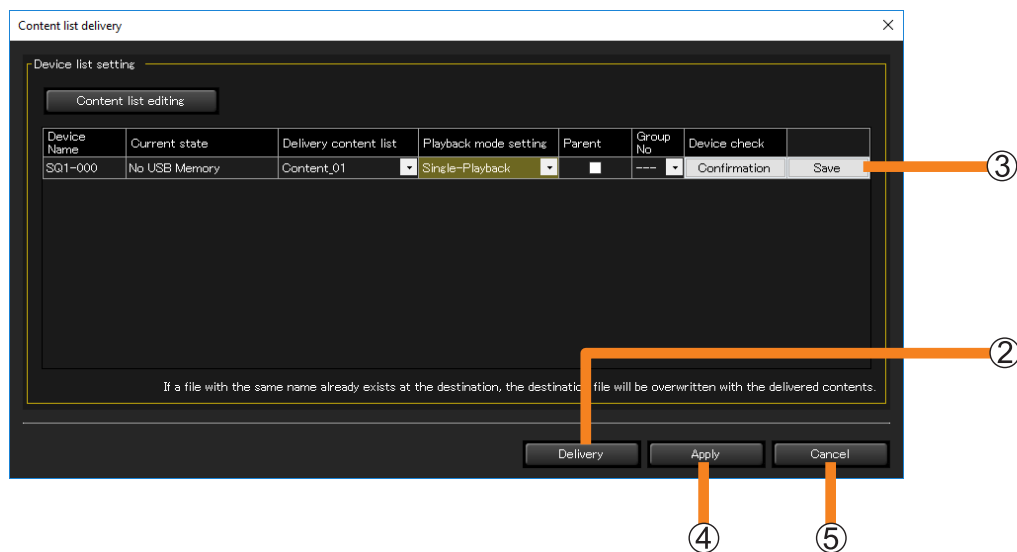

② **[Delivery]:** The files are saved to the USB memory inserted in the device of the delivery destination, and the content list delivery is executed.

③ **[Save]:** The content list is saved on the computer you are using. Specify a save destination. If a USB memory device used with a delivery destination device has been inserted into the computer, it can be directly saved on the USB memory device.

- The files to be saved as a content list are as follows.

- **File list (filelist.dat):**

The file name of the content to be played back is recorded in this file.

- **Scenario file (scenario.dat):**

The playback time of each content file, and the playback order of the content are recorded in this file.

- **Playback file:**

This is the still image or movie file used for playback.

- To temporarily save the content lists during the editing process, click [Apply] (④). The mid-edit content lists will appear in the <Content list delivery> window the next time you open it.
- To discard content lists mid-creation or mid-edit, click [Cancel] (⑤). You will return to the <Create Schedule>, <Edit Schedule>, or <Device Monitoring> window.

### Creating a List to Distribute Images ([Delivering contents list])

---

#### Notes

- It may take a while for delivery to complete depending on the sizes of the content files.
- The functions set in “POWER MANAGEMENT SETTINGS” of the flat panel display are disabled during content list delivery.
- If a flat panel display that is a delivery target is playing existing content with the USB media player, playback stops simultaneously with the start of content list delivery and then resumes with the new content after delivery completes.
- If the delivery target projector is playing back an existing scenario in Memory Viewer, playback stops simultaneously with the start of content list delivery and then resumes with the new scenario after delivery completes.
- When content list delivery is executed, the settings specified in [Device list setting] are automatically saved. The automatically saved settings will appear in the <Content list delivery> window the next time you open it.
- If the power of the device unit is turned off or the connection with the unit is disconnected during delivery, the delivery will fail. Check the status of the connection with the unit and then execute delivery again.

## Calling the Web Control Window

The software can be used to call up the device web control function.

### Preparation:

- Uncheck “Use automatic configuration script” in your web browser.
- Uncheck “Use a proxy server for your LAN” in your web browser, or specify the device IP address in “Exceptions” in the advanced proxy settings.

### 1 In the Brief information display area in the <Device Monitoring> window, select the device you want to display, right-click it, and select [WEB Control].

- You can also display it by double-clicking the selected row.
- To display from the web browser of the early warning function, select the device you want to display and click [WEB Control]. (page 183)

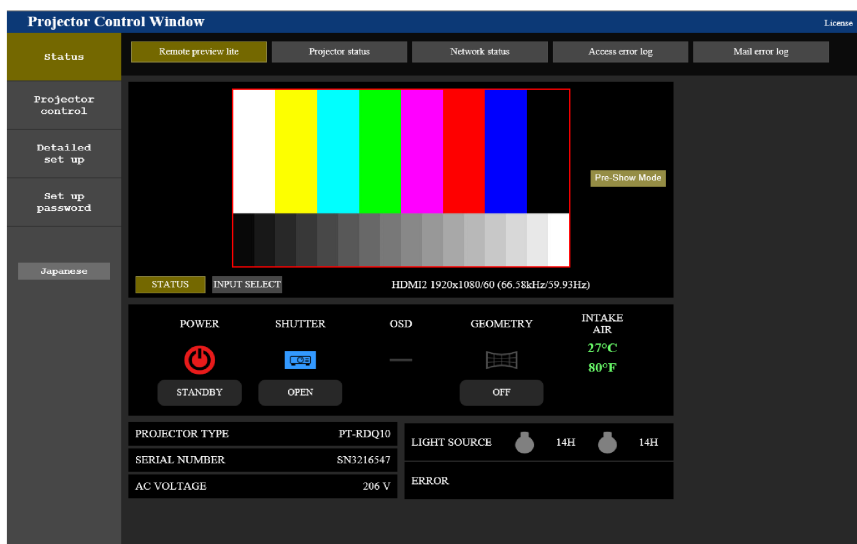
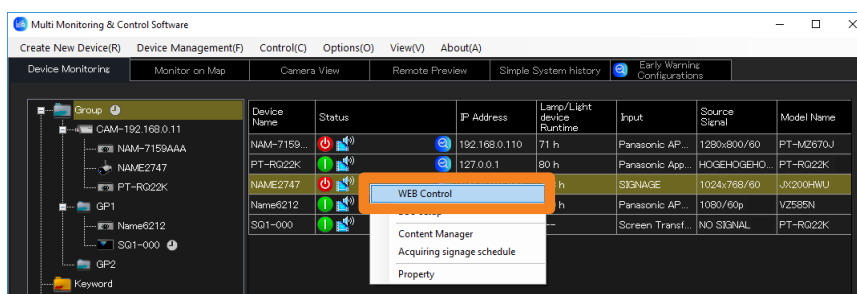



## Calling the Web Control Window

---

### Notes

- For details about the web control function, please refer to the operating manual for the device being used.
- The <Web Control> window will vary according to the device being used.
- When the web control function is opened, the administrator password change screen may appear. If the administrator password is changed, acquisition of detailed information will not be possible until the device is re-registered. Re-register the device as described in “Registering Devices and Peripheral Devices to Monitor and Control” (page 39).
- If the connection setting on the device side is HTTPS communication, you cannot call up the WEB control function from this software. In that case, enter the device’s IP address into the URL input field of the WEB browser, and call up the WEB control function.
- During [Pre-Show Mode], the logo cannot be transferred using Logo Transfer Software.

## Calling the Web Control Window

## Using the ECO Management Function

Bring up the <Web Control> window while the [ECO management set up] screen is displayed. You can configure the power consumption reduction settings for the projector in [ECO management set up].

- To display the <Web Control> window from [WEB Control] on the menu, select [Detailed set up] from the menu on the left, and click [ECO management set up]. (page 168)

### Preparation:

- Uncheck “Use automatic configuration script” in your web browser.
- Uncheck “Use a proxy server for your LAN” in your web browser, or specify the device IP address in “Exceptions” in the advanced proxy settings.

- 1 In the Brief information display area in the <Device Monitoring> window, select the device you want to display, right-click it, and select [ECO setup].**

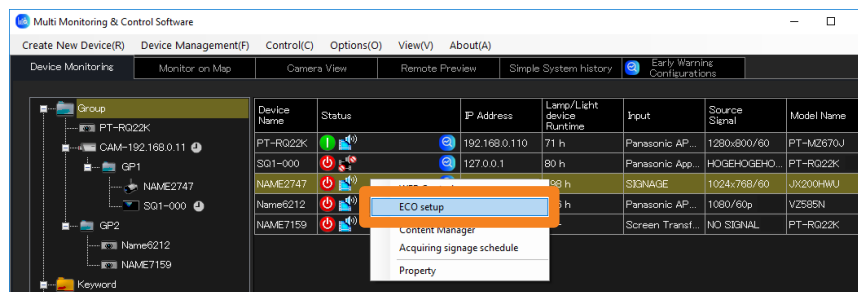

- 2 Change the settings and click [Submit].**

The settings will be applied to the projector. After some time, the [ECO setup level] icon in the row selected in step 1 will be updated. The time it takes to update differs depending on the [Interval time] set at [Interval Time of Device Information]. (page 229)

- What appears in the setting window will be different depending on the projector you are using.

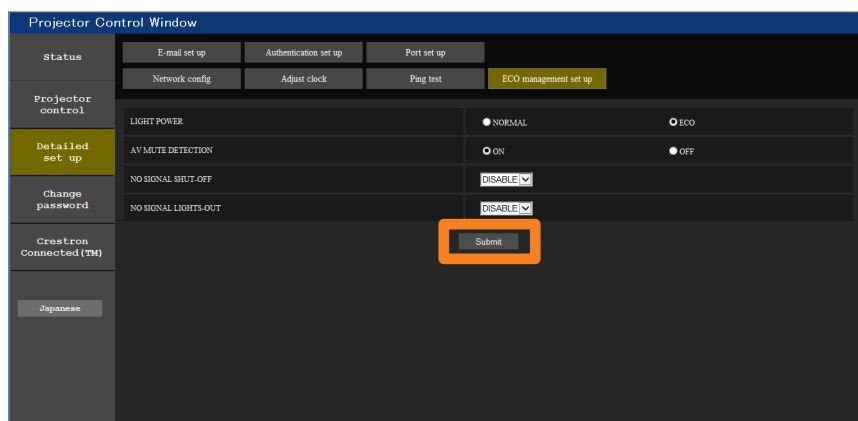

### Notes

- For details of the ECO Management function, refer to the operation manual of the device you are using.

# Calling the Geometry Manager Pro

You can call up the Geometry manager Pro installed in your computer from this software.

- 1 In the Brief information display area in the <Device Monitoring> window, select the device you want to display, right-click it, and select [Geometry Manager Pro].

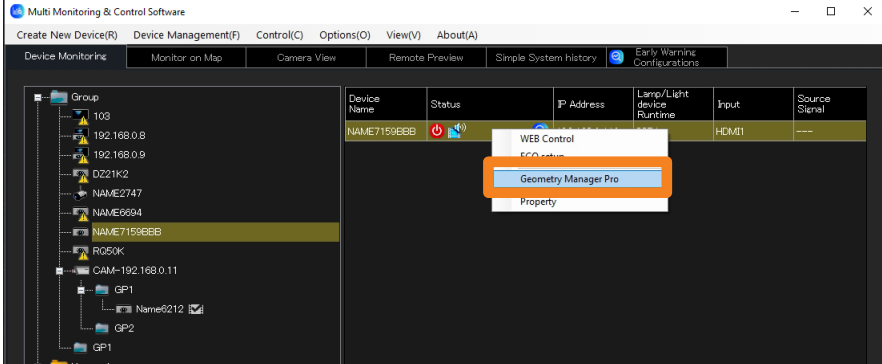

## ■ Calling directly from the menu

- 1 From the tree pane of the <Device Monitoring> window, select the icon for a device, group, or keyword, right-click it, and select [Call application] → [Geometry Manager Pro].

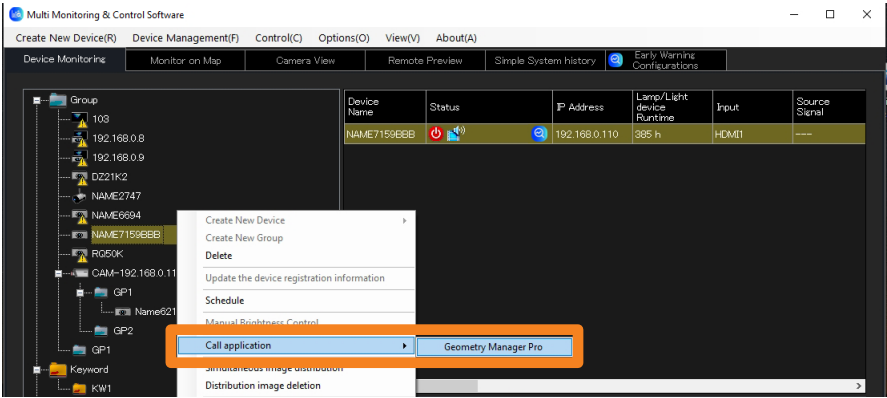

## Notes

- Only models that has the status displayed in [Geometry] can call up Geometry Manager Pro.

## Calling the Content Manager

The Content Manager of the projector can be called up from this software.

### Preparation:

- Uncheck “Use automatic configuration script” in your web browser.
- Uncheck “Use a proxy server for your LAN” in your web browser, or specify the device IP address in “Exceptions” in the advanced proxy settings.

**1** In the Brief information display area in the <Device Monitoring> window, select the device you want to display, right-click it, and select [Content Manager].

- The Content Manager can be called only on devices that display the signage playback status in [Signage information].

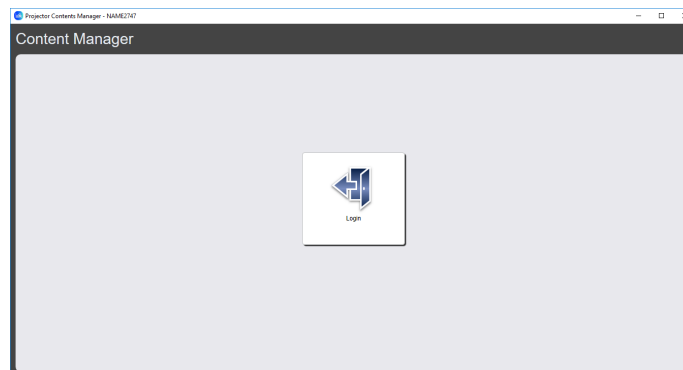
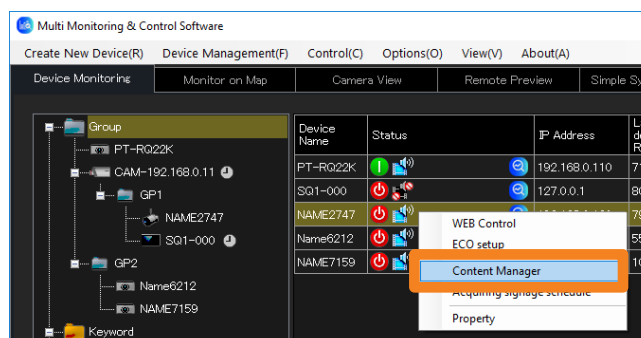

### Notes

- For details about [Content Manager] after login, refer to the operating manual of the projector you are using.

## Acquiring and Delivering a Signage Schedule

This function allows you to acquire the signage schedule configured for a projector and then deliver the signage schedule to multiple other projectors. This eliminates the need to create the same signage schedule for each projector.

- The signage schedule acquisition and delivery functions are supported only on projectors equipped with Content Manager. To see if the projector being used is supported, refer to the “List of Compatible Device Models” of this application software which is posted on the following website.

<https://panasonic.net/cns/projector/download/application/>

### Acquiring a Signage Schedule

- 1 In the Brief information display area in the <Device Monitoring> window, select a projector, right-click it, and select [Acquiring signage schedule].

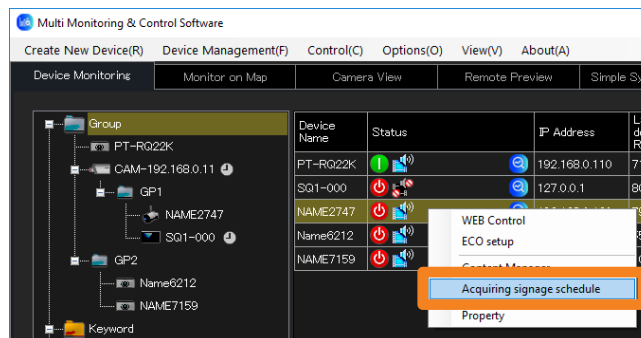

- 2 Click [List view].

The signage schedule set to the selected projector will be displayed.

- The list of acquired signage schedules is displayed in tabs labeled [By day] and [By weekday].

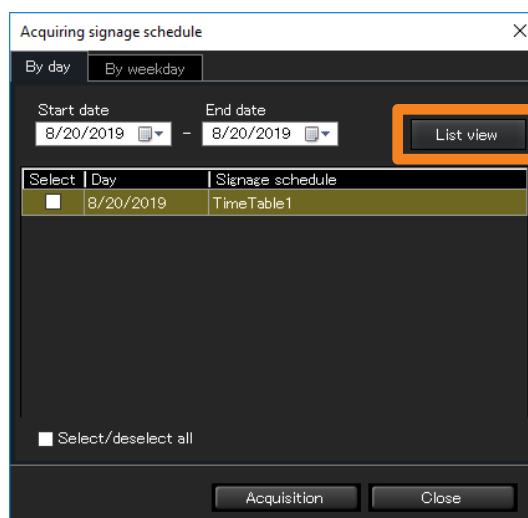

## Acquiring and Delivering a Signage Schedule

### 3 Place a check mark in [Select] for the signage schedule you want to acquire and click [Acquisition].

- Because the contents (video or audio) registered in the schedule are also acquired, acquisition may take some time to complete, depending on signage schedule.
- When acquiring a signage schedule any previously acquired signage schedule is deleted.
- If the names of files included in a signage schedule include invalid URL characters (#, %, [, ], {, }, '), acquisition of the signage schedule will not be possible.

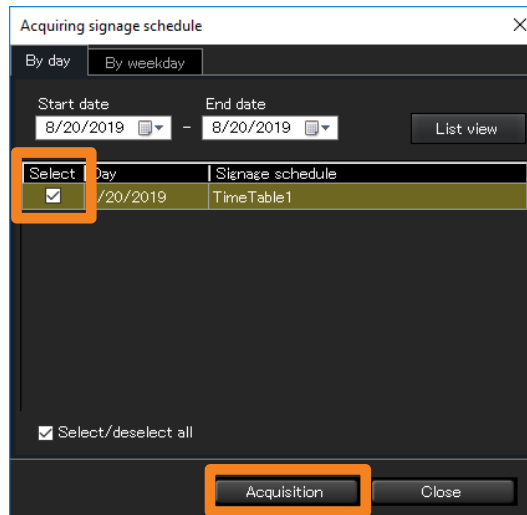

- The signage schedule list is displayed when acquisition is successful. The following message is displayed if acquisition fails. In this case, check whether there is a registered signage schedule for the target projector, then try to acquire the schedule again.

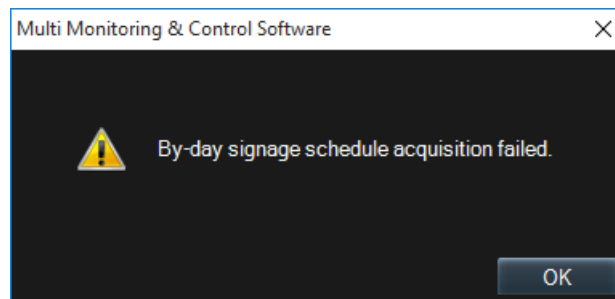

## Acquiring and Delivering a Signage Schedule

## Delivering a Signage Schedule

- 1 In the Brief information display area in the <Device Monitoring> window, select a projector, right-click it, and select [Delivering signage schedule].

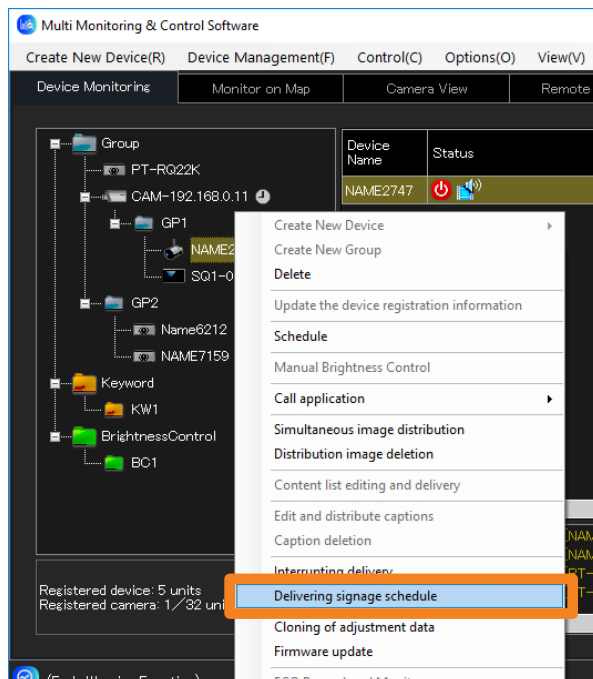

- 2 Place a check mark in [Select] for the signage schedule you want to deliver.

- The list of acquired signage schedules is displayed in tabs labeled [By day] and [By weekday].

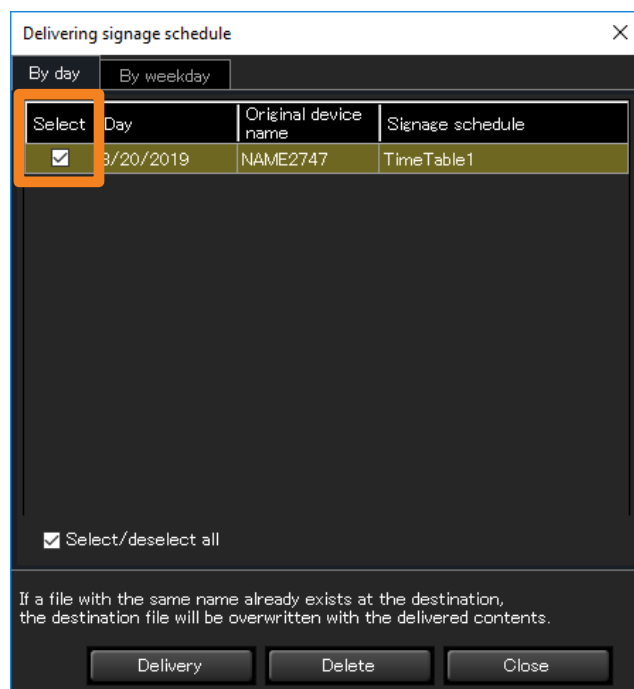

## Acquiring and Delivering a Signage Schedule

### 3 Click [Delivery].

A confirmation message appears. Click [OK] to distribute the selected signage schedule.

- If a file with the same name as the contents, registered in the schedule, for delivery already exists on the delivery destination, the destination file will be overwritten, even if the contents have a different name. In this case, the contents registered in the signage schedule on the destination will be replaced by the contents registered in the delivered schedule.
- Because the contents (video or audio) registered in the schedule are also acquired, acquisition may take some time to complete, depending on signage schedule.
- When the power supply to the projector is turned off such as disconnecting the AC plug during delivery, or when the network connection is cut off, no delivery will be possible. Check the status of the connection with the unit and then execute delivery again.
- If no signage schedule has been acquired, an error message is displayed. Acquire the signage schedule first and then carry out [Delivery]. (page 173)

### 4 Click [Close] to close the window.

## Deleting a Signage Schedule

### 1 In step 2 of “Delivering a Signage Schedule” (page 175), place a check mark in [Select] for the signage schedule you want to delete and click [Delete].

A confirmation message appears. Click [OK] to delete the selected signage schedule.

- The contents (video or audio) registered in a signage schedule are retained on the computer after the acquired signage schedule is deleted. The contents (video or audio) are deleted from the computer only after all acquired signage schedules have been deleted.

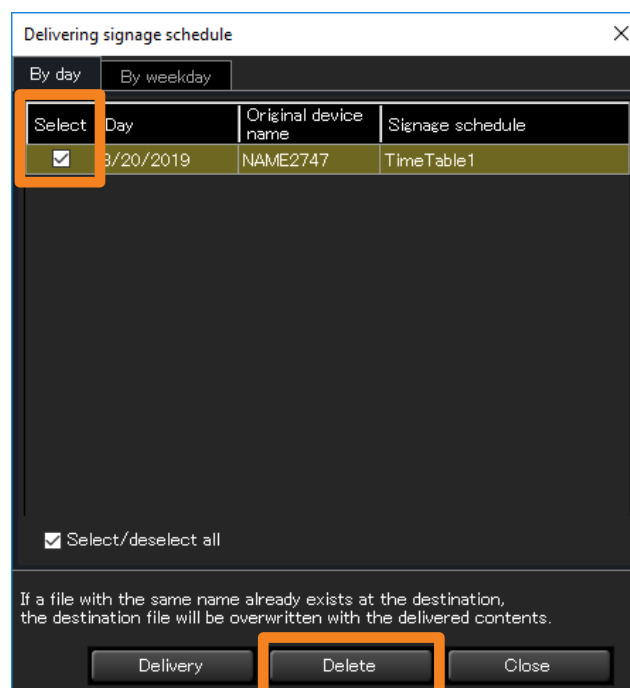



## Delivering the master device data all at once

This function allows you to copy the menu settings and adjustment values of the one master device to other multiple devices, which is similar to the LAN cloning function that is enabled using the device menu or dedicated tool.

- The master device data can be delivered only to devices of the same model as the one master device.  
To see if the projector you are using supports data cloning, refer to the “List of Compatible Device Models” of this application software which is posted on the following website.  
<https://panasonic.net/cns/projector/download/application/>

## Acquiring the master device data

- 1 In the Brief information display area in the <Device Monitoring> window, select a device, right-click it, and select [Get adjustment data].**

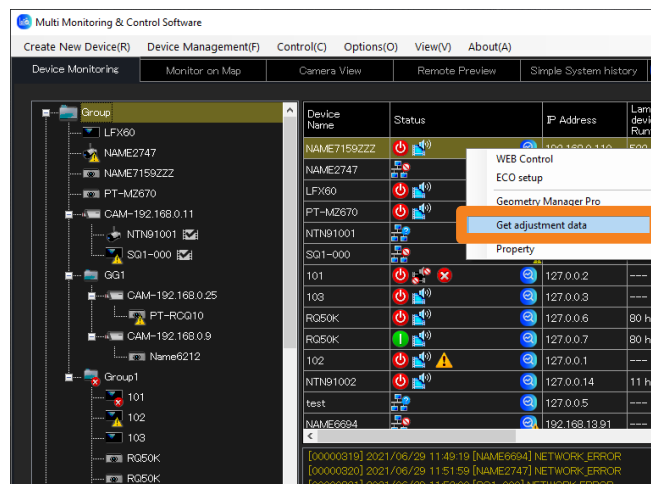

- 2 Select the save destination, and click [Save].**

- The USB cloning data file acquired directly from the device is saved at the same time.  
Default file name: Model name + Serial No.cdf (For this application)  
Model name\_01.cdf (The USB cloning data file is saved in the folder with “Model name + Serial No.”.)
- When the message of successful saving is displayed, click [OK].

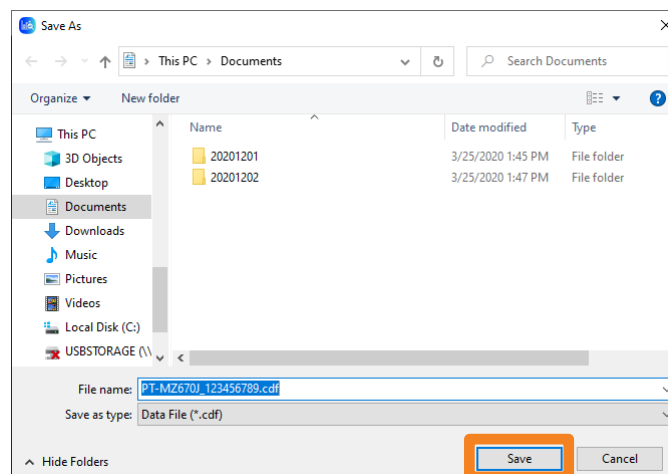

Delivering the master device data all at once

## Delivering the acquired adjustment data all at once

**1** From the tree pane of the <Device Monitoring> window, select  (group folder), right-click it, and select [Cloning of adjustment data].

- Adjustment data will be delivered to all devices in the selected folder. If there is a model that is not applicable, it will be displayed as an error in the delivery result, which is displayed after delivery. (page 179)

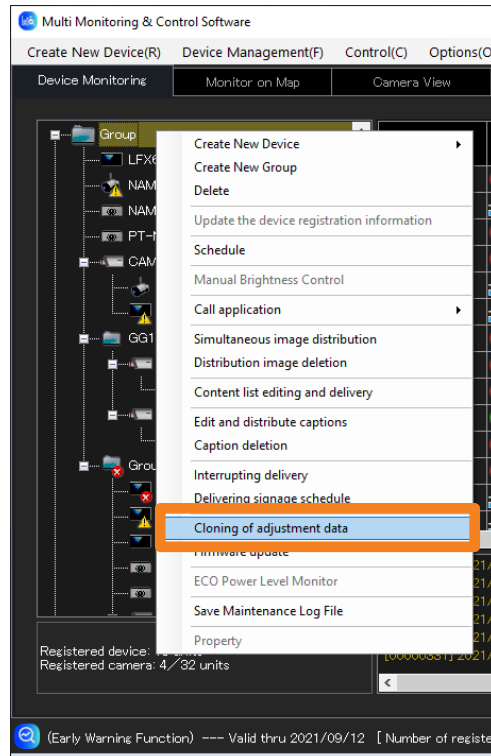

**2** When the confirmation message is displayed, click [Yes].

The delivery is cancelled when [No] is selected.

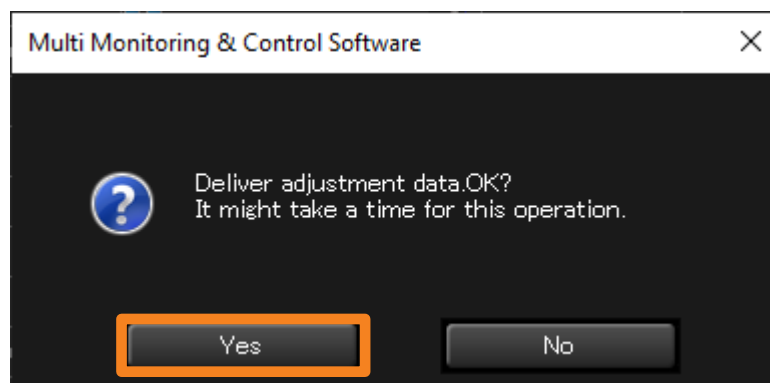

## Delivering the master device data all at once

**3 Select the adjustment data file you want to deliver, and click [Open].**

- In addition to the data acquired in “Acquiring the master device data” (page 177), the cloning data saved directly to the USB memory from the main device can also be selected.

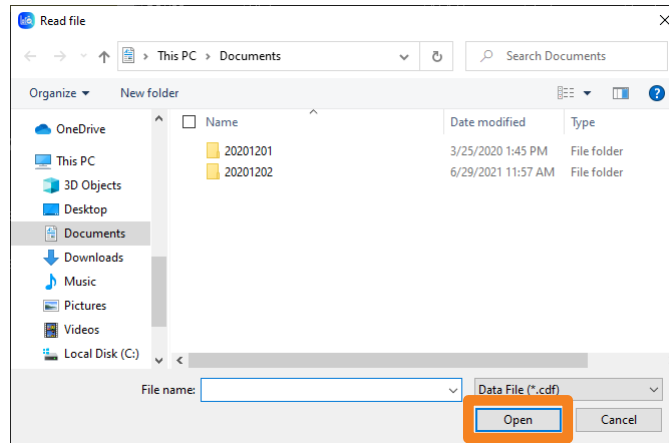

- The delivery result will be displayed in the command execution log pane of the <Device Monitoring> window.
  - Delivery succeeded: Displayed in white letters
  - Delivery failed: Displayed in yellow letters

**Notes**

- For more details on the data that can be acquired by data cloning, and/or how to save the data to a USB memory from the device, refer to respective operating manuals of your devices.
- Do not change the file name of adjustment data that has been acquired for USB cloning, but use the original file name at the time of acquisition. Only the file name for this application can be changed. (page 177)

# Using the Early Warning Function

## Confirming the Status of Devices and Peripheral Devices

If you add the early warning function, you can check the status of the devices and their peripheral devices registered on the monitoring and control terminal from the Multi Monitoring & Control area or from a web browser.



### ① Window switching button:

- [Detailed/Overview]: Every time you press it, the Details (page 183) and Overview (page 191) window will switch.
- [History (All Device)] (page 196)
- [Control] (page 199)

### ② Logout button:

- When clicked, you will be logged out from the WEB browser of Early Warning.

### ③ Tree view area:

The registered equipment in each group is listed in tree format. When an error, warning or notification occurs in a device, an icon appears next to the corresponding device. (page 181)

### ④ Data display area:

Displays information about the devices selected in the tree view area. (page 183)

## Notes

- The items and information displayed will vary depending on the registered device or peripheral device.
- Regardless of the connection environment such as wired connection/wireless connection, when the communication environment is unstable, the device information may not be properly retrieved.





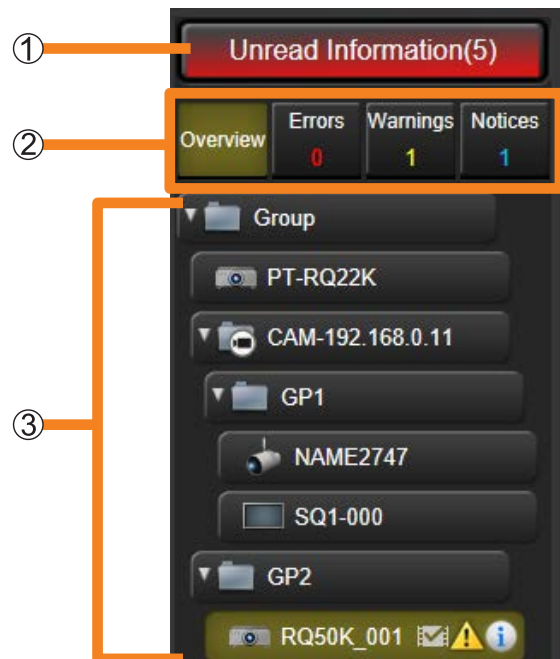



## Confirming the Status of Devices and Peripheral Devices

## Tree View Area



<p>① Unread information</p>	<p>When there are unread status notification (②), ① will turn red and the number of unread messages will be displayed.</p> <ul style="list-style-type: none"> <li>When you click this, the data display area on the right becomes the History (All Device) screen (page 196), which shows unread errors against a red background and warnings and notifications against a yellow and blue background, respectively.</li> </ul>
<p>② Status notification tab</p>	<p>The [Errors], [Warnings], and [Notices] tabs indicate the number of devices that have generated errors, warnings, and notifications, respectively. Selecting a tab indicating that events have occurred will show a list of the devices in the tree view area where the events have occurred.</p> <p><b>✖ [Errors]:</b> The software detects and indicates filter clogging errors, intake/exhaust/optical module and other temperature errors, lamp or light device runtime errors, lamp or light source on errors, fan errors and other errors. In addition, errors based on status notifications received from devices can be displayed.</p> <ul style="list-style-type: none"> <li>For more information about setting the status notification function, see page 233.</li> </ul> <p><b>⚠ [Warnings]:</b> The software detects and indicates filter clogging warnings, intake/exhaust/optical module and other temperature warnings, lamp or light device runtime warnings, LAN disconnected warnings and other warnings.</p> <p><b>i [Notices]:</b> The software can detect and display notifications such as the cleaning time and replacement time of each part, and when video stop occurs.</p> <ul style="list-style-type: none"> <li>For more information about configuring notifications, see page 245.</li> <li>See page 202 and 251 for video stop determination settings.</li> </ul>

## Confirming the Status of Devices and Peripheral Devices

<p>③ Tree pane</p>	<p> <b>[Group]:</b> This is the folder that the tree is composed from. It cannot be changed or deleted.</p> <p> : Group folder created on the monitoring and control terminal side</p> <ul style="list-style-type: none"> <li>• You can click this to select whether to display or hide the devices registered in the group.</li> </ul> <p> : A group folder created on the monitoring and control terminal side with a network camera as the parent.</p> <ul style="list-style-type: none"> <li>• You can click this to select whether to display or hide the devices registered in the group.</li> </ul> <p> : Projector (Rich information model)</p> <p> : Flat panel display (Rich information model)</p> <p> : Basic information model device</p> <ul style="list-style-type: none"> <li>• When you set video stop determination with a device linked to a network camera,  will be displayed on the right side of the device name. (page 202)</li> <li>• In the following cases, the device's icon changes.</li> </ul> <p> : A device cannot be found</p> <p> : A device that differs from the registered device type has been detected</p>
--------------------	--

**Notes**

- When the name of a device or group is too long to fit in the display area, “...” follows the name.
- Depending on the network connection status, it may take some time to display the unread information count.
- The detection items that generate notifications vary with the device.
- For details about “Rich information model” and “Basic information model”, see page 25.

# Confirming Device and Peripheral Device Status

(Detail Screen)

## Data Display Area

- 1 Select a device at the tree view area, then click the [Status] tab. The status (condition) of the selected device appears in the data display area.

The screenshot shows the main status screen with the following components and callouts:

- 1**: Points to the 'Status' tab.
- 2**: Points to the device information table.
- 3**: Points to the 'Power on hours' section.
- 4**: Points to the 'Environment Info' tab.
- 5**: Points to the 'Refresh' button.
- 6**: Points to the temperature gauges.
- 7**: Points to the 'Peripheral Device' section.
- 8**: Points to the 'Remaining Filter Life' indicator.
- 9**: Points to the fan status gauges.

Group Name	IP Address	Shutter(AV Mute)
GP2	192.168.0.217	OPEN(OFF)
Model Name	Serial Number	Selected input
	SN1234567	HDMI
Power	Power on count	Source Name
ON	20times	WXGA60
Selected LIGHT	Operating Mode	Signal Freq.
--	--	31.5kHz/60Hz
Main/Sub Version	Network Version	AC Voltage
1.08/1.00	2.34	100V

The 'Peripheral Device' tab shows a camera feed of two dogs. Below the feed are two buttons: 'DIGITAL LINK' and 'Camera WEB'.

The 'Peripheral Device' tab shows a camera feed of a hurdle race. Below the feed are two buttons: 'DIGITAL LINK' and 'Camera WEB'.

10

11

12

13

## Confirming Device and Peripheral Device Status (Detail Screen)

① <b>Device name</b>	Displays the device name.
<b>[Group Name]</b>	Displays the device's group name. (If the group folder is  , the set network camera name at the time of network camera registration or CAM-XXX (XXX: network camera's IP address) will be displayed as the group name.)
<b>[Model Name]</b>	Displays the device model name.
<b>[Power]</b>	Displays the power status of a device. <b>[STANDBY]:</b> Standby status <b>[COOLING]:</b> Power supply is being cooled <b>[WARM UP]:</b> Warming up <b>[ON]:</b> Power supply is on
<b>[Selected LIGHT]</b>	(Projector only) Displays lamp selection status. The displayed content varies with the registered device. [SINGLE], [DUAL], [TRIPLE], [QUAD], [LIGHT1/2/3], [LIGHT1/2/4], [LIGHT1/3/4], [LIGHT2/3/4], [LIGHT1/4], [LIGHT2/3], [LIGHT1], [LIGHT2], [LIGHT3], [LIGHT4]
<b>[Main/Sub Version]</b>	Displays the version of the device's main and sub microcomputer.
<b>[IP Address]</b>	Displays the device's IP address.
<b>[Serial Number]</b>	Displays the serial number of a device.
<b>[Power on count]</b>	Indicates the number of times a device has been powered on.
② <b>[LIGHT Power]</b>	(Projector only. The displayed content varies with the registered device.) Displays the setting status of the light power (lamp power, lamp output, light output) of a device.
<b>[Operating Mode]</b>	(Projector only. The displayed content varies with the registered device.) Displays configuration status of the device's Operation Mode. If the brightness control function is enabled on the device, the configuration status of the device is not displayed.
<b>[Power consumption reduction setting]</b>	(Flat-panel display only) Displays the power consumption reduction setting of the device. <b>[Off] / [On] / [Sensor]</b>
<b>[Long Life Mode]</b>	(Flat-panel display only) Displays the Long Life Mode setting status of the device. <b>[Off] / [On 1] / [On 2]</b>
<b>[Network Version]</b>	Displays the version of the device's network microcomputer.
<b>[Shutter (AV Mute)]</b>	Displays device shutter status or AV mute status. <b>[OPEN(OFF)]:</b> When shutter is open or AV is unmuted (video and audio) <b>[CLOSE(ON)]:</b> When shutter is closed or AV is muted (video and audio)
<b>[Selected input]</b>	Displays the status of a selected input.
<b>[Source Name]</b>	Displays the source name of device.
<b>[Signal Freq.]</b>	Displays the signal frequency of a device. For flat-panel displays*, the indication is displayed in red to indicate a warning/error if a no-signal condition is continuous.

\* In the following situations, warning and error detection for no-signal conditions are not possible for flat-panel displays that support USB input.



- When USB input is selected and a USB storage device is not inserted in the USB port
- When USB input is selected and an unplayable file exists on the USB storage device

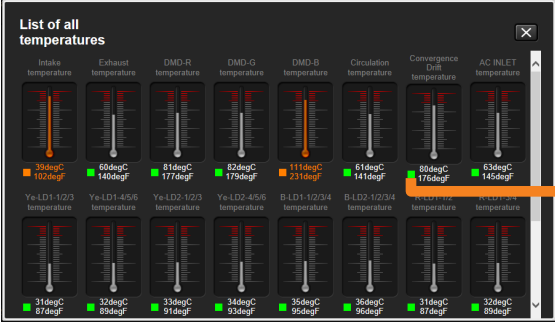

## Confirming Device and Peripheral Device Status (Detail Screen)

② [AC Voltage]	(Projector only) Displays the voltage of the AC power supply being input to the device.
③ [Power on hours]	Displays a graph that shows the power on hours for a device for a 30-day period in 1-day increments. It does not display data for the day when a device is registered or days when it is not in use. For a “Basic information model” device, the light device runtime will be used to determine the device usage time. Depending on the “Basic information model” device, as the light device runtime will be a converted value, it may be shorter than the actual device usage time. In addition, graph display is not possible for “Basic information model” devices for which the light device runtime cannot be obtained.
④ [WEB Control]	Displays the log in screen for connecting devices. Entering the user name and password of a device will open its <Web Control> window. The log in screen and the <Web Control> window will not appear for “Basic information model” devices and devices that do not support web control.
⑤ [Refresh]	The data display area will be updated to the latest state. (It may take time to update depending on the network connection.)
⑥ Temperature	<p>Displays thermometers and temperature values in Celsius (°C) and Fahrenheit (°F) for points within the device.</p> <p>[All]: Displays the status of the temperature sensor as a list.</p>  <p><b>Green:</b> Normal <b>Orange:</b> Warning <b>Red:</b> Error</p> <p>Note that the displayed temperature parameters vary with the device.</p> <ul style="list-style-type: none"> <li>• For projectors, the intake air temperature, optics module temperature, and temperature near the lamps or light sources are displayed. The numerical temperature values will change from white to orange when the warning temperature is reached. In this case, take corrective action immediately. If no action is taken and the temperature continues to rise, the color will change to red and the device will shut down.</li> <li>• For flat-panel displays, the internal temperature, panel temperature, intake air temperature, and exhaust air temperature are displayed. If the temperature reaches the warning level, the temperature value readout changes from white to orange, and if the temperature continues to increase, it changes to red and an error message is displayed prompting you to take immediate action. If no action is taken and the temperature continues to rise, the device will shut down.</li> </ul>
⑦ LIGHT status	(Projector only) Indicators show lamp status and power on hours. The indicator turns orange if the lamp usage time reaches the replacement warning time, and turns red when it reaches the time for replacement. For projectors that allow setting of the lamp power or lamp output to “ECO” or “low”, the displayed lamp usage time is calculated as if the lamp was used with the lamp power or lamp output set to “normal” or “high”.

## Confirming Device and Peripheral Device Status (Detail Screen)

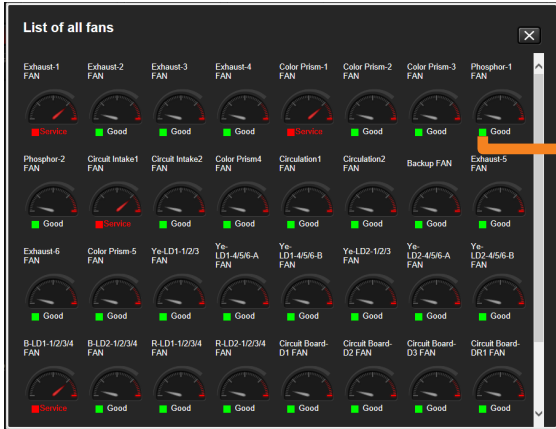
<p>⑧ <b>Remaining ACF service life</b></p>	<p>(Only projectors equipped with the auto cleaning filter function) This indicator shows remaining life of the ACF in percentage. When the remaining life of the filter is less than 200 hours, the indicator lights orange.</p>
<p>⑨ <b>Fan status</b></p>	<p>Displays the name of the fan equipped on the device and a meter indicating its status.</p> <p><b>Projector</b></p>  <p><b>Actual fan speed</b></p> <p><b>Flat panel display</b></p>  <p><b>Target fan speed</b></p> <p><b>Actual fan speed</b></p> <p>[All]: Displays the status of the fans equipped on the devices as a list.</p>  <p><b>Green: Normal</b> <b>Orange: Notice*</b> <b>Red: Service</b></p> <p>* Flat-panel display only</p> <p>Note that the displayed meters vary with the device.</p> <ul style="list-style-type: none"> <li>• For projectors, if the fan speed drops and normal speed cannot be maintained, the meter needle changes from white to red, and the status changes from [Good] to [Service].</li> <li>• For flat-panel displays, if the temperature rises and the fan speed is abnormal, the meter needle changes to orange, and the status changes from [Good] to [Notice]. If the fan stops due to a failure, the meter needle changes from white to red, and the status changes to [Service].</li> </ul>
<p>⑩ <b>[Peripheral Device]</b></p>	<p>The current delivering image of the network camera is displayed which is registered to the device displayed in the status screen. The video of the network camera is updated at about 4-second intervals.</p>
<p>⑪ <b>[Camera WEB]</b></p>	<p>A button is displayed when the [Peripheral Device] tab is double-clicked. This is enabled when a network camera is registered to the device displayed in the status screen. It displays the Web screen of the network camera.</p>
<p>⑫ <b>[DIGITAL LINK]</b></p>	<p>A button is displayed when the [Peripheral Device] tab is double-clicked. This is enabled when a DIGITAL LINK Switcher is registered via linking to the device displayed in the status screen. It displays the input/output condition and the built-in fan condition of the DIGITAL LINK Switcher. For details of [DIGITAL LINK] settings, see page 188.</p>
<p>⑬ <b>[Remote Preview]</b></p>	<p>Footage input into a device displayed in the status screen can be resized as snap shot images. Snap shot images are displayed in 250 millisecond intervals at its fastest speed. (Display intervals change drastically depending on the network environment, the computer's capabilities and the number of registered devices.)</p>

## Confirming Device and Peripheral Device Status (Detail Screen)

---

### Notes

- The items and content displayed in the status screen will vary depending on the device.
- The video from the network camera can be displayed when the network camera is connected to the same network as the monitoring and control terminal.
- The network settings and authentication settings of network cameras differ depending on the camera. Refer to the instruction manual of the corresponding network camera and then configure the settings.
- The video of the network camera is intended to be used for the purpose of monitoring a specific display video, and is not for preventing crime or other purposes.
- It is the customer's responsibility to give sufficient consideration to not violating the privacy of any person, group, or other entity that becomes a subject in the video of the network camera.
- The video of a network camera may not appear clear depending on the type of projector.
- To see the following websites for network cameras recommended for this software, refer to the "List of Compatible Device Models" of this application software which is posted on the following website.  
<https://panasonic.net/cns/projector/download/application/>  
<https://panasonic.net/cns/prodisplays/download/software/>
- The <Web Control> window of the device may become unable to be displayed properly in iOS (Safari) depending on the network camera.

## Confirming Device and Peripheral Device Status (Detail Screen)

### ■ DIGITAL LINK Switcher input/output condition

Clicking [Peripheral Device] in the data display area and then clicking [DIGITAL LINK] will display the input/output condition and the built-in fan condition of the DIGITAL LINK Switcher. This is enabled when a DIGITAL LINK Switcher is registered with the device displaying the status.

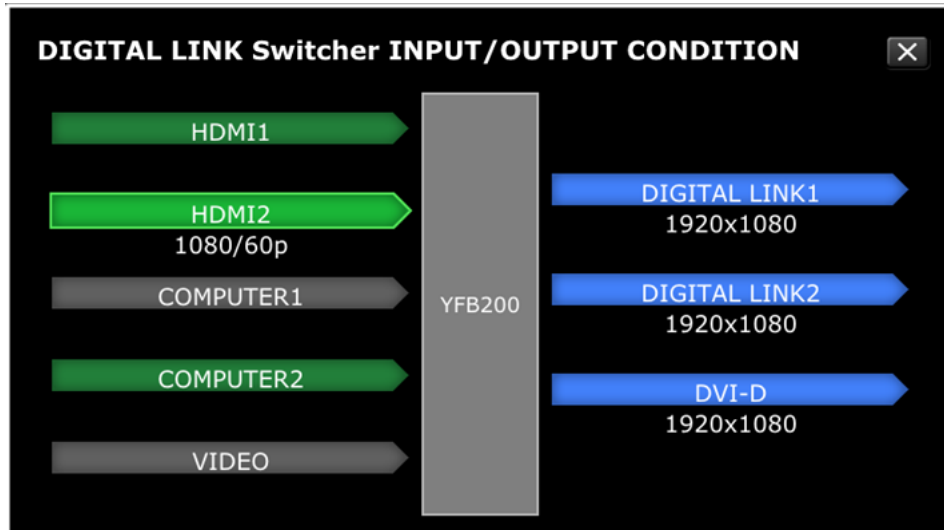

#### Input signal conditions

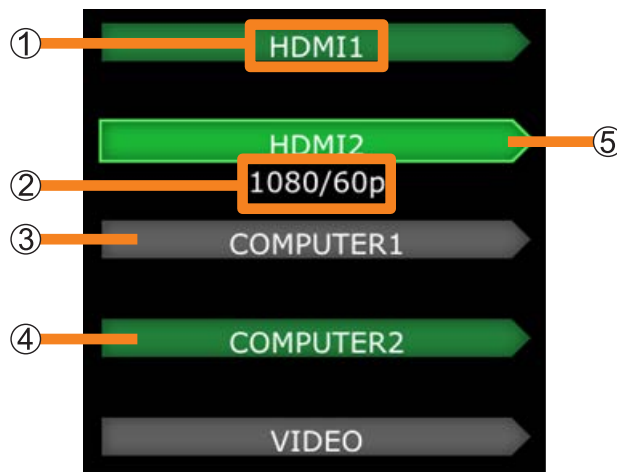

① <b>Input terminal name</b>	Displays the name of an input terminal of the DIGITAL LINK Switcher.
② <b>Input video signal name</b>	Displays the input video signal name.
③ <b>No video input signal*<sup>1</sup></b>	This is the condition of the video input not selected and no video signal being input. <ul style="list-style-type: none"> <li>If video input is selected, but no video signal is input, the status will be as follows.*<sup>2</sup></li> </ul> 
④ <b>Video input signal*<sup>1</sup></b>	This is the condition of the video input not selected but a video signal being input.
⑤ <b>Video input signal*<sup>2</sup></b>	This is the condition of the video input selected and a video signal being input. The signal name is also displayed.

\*<sup>1</sup> Status when not selected as input

\*<sup>2</sup> Status when selected as input

## Confirming Device and Peripheral Device Status (Detail Screen)

### Output signal conditions

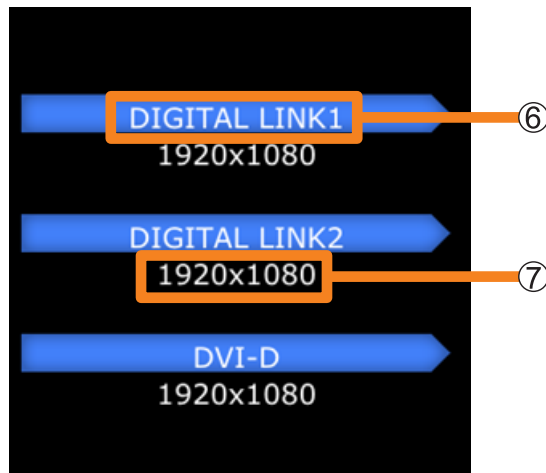

⑥ Output terminal name	Displays the name of an output terminal of the DIGITAL LINK Switcher.
⑦ Output video signal name	Displays the output video signal name.

### Other

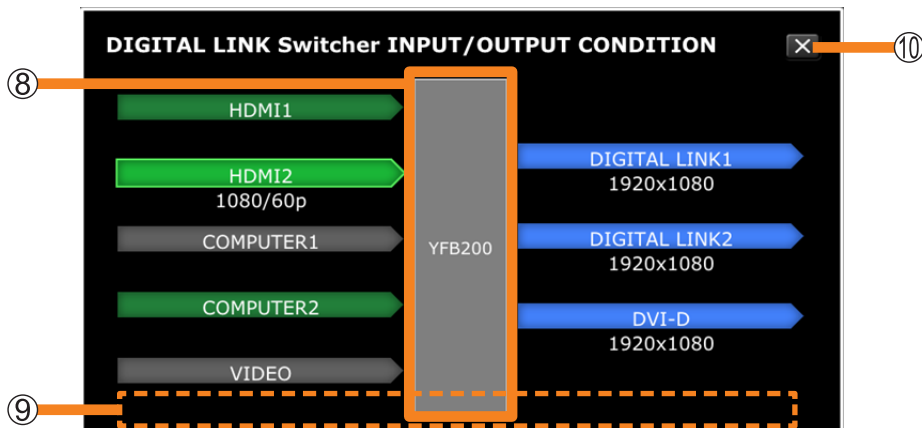

⑧ Device name and fan status of the DIGITAL LINK Switcher	<ul style="list-style-type: none"> <li>• Device name is displayed.</li> <li>• When the fan built into the DIGITAL LINK Switcher is rotating unstably or is stopped, the color of the box of the DIGITAL LINK Switcher changes and a message is displayed to notify you of the status. When there is no problem with the fan, the box is displayed in gray as shown in ⑧.</li> </ul>
	<div style="display: flex; justify-content: space-around;"> <div style="text-align: center;"> <p>Condition display when the fan speed is unstable (box is orange)</p> </div> <div style="text-align: center;"> <p>Condition display when the fan is stopped (box is red)</p> </div> </div>
⑨ Message display area	This area is for displaying messages about the condition of the fan of the DIGITAL LINK Switcher and when there are other notices.
⑩ Close button	Closes this status screen and returns to the status screen of the device.

## Confirming Device and Peripheral Device Status (Detail Screen)

**Notes**

- The following messages may be displayed in the message area depending on the settings of the DIGITAL LINK Switcher.

DIGITAL LINK Switcher Settings	Message
CLOSED CAPTION setting is "ON"	CLOSED CAPTION is "ON". VIDEO input status may not be displayed correctly.
[INPUT SETTING] of COMPUTER1 terminal is "Y/C"	COMPUTER1 INPUT SETTING is "Y/C". VIDEO input status or COMPUTER1 input status may not be displayed correctly.
CLOSED CAPTION setting is "ON" and [INPUT SETTING] of COMPUTER1 terminal is "Y/C"	Closed caption is "ON" and COMPUTER1 INPUT SETTING is "Y/C". VIDEO input status or COMPUTER1 input status may not be displayed correctly.

- If you want to obtain the input/output condition of the DIGITAL LINK Switcher again, click the close button (ⓧ) and then display this status screen again.

# Displaying a List of Registered Devices





(Overview screen)

## 1 Click [Detailed/Overview] to switch to the Overview screen.

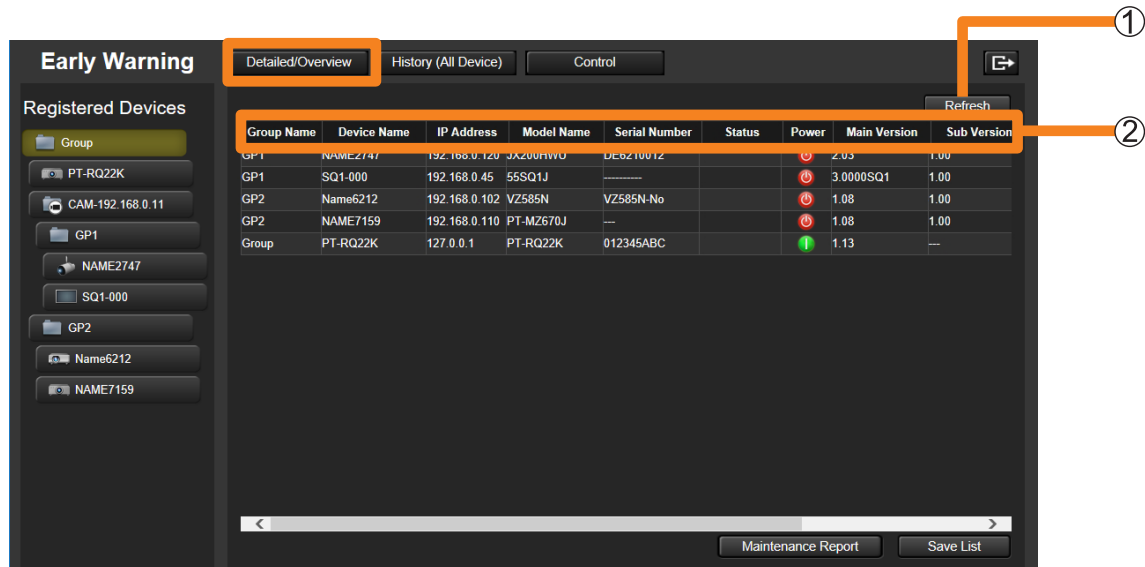
A list of registered devices appears.

- Click [Detailed/Overview] again to return to the [Detail Screen].



① [Refresh]	The data display area will be updated to the latest state.
[Group Name]*	Displays the group name of a device. (If the group folder of the tree pane is  , the camera name set at the time of network camera registration or CAM-XXX (XXX: network camera's IP address))
[Device Name]*	Displays the device name.
[IP Address]*	Displays the device's IP address.
[Model Name]*	Displays the device model name.
[Serial Number]*	Displays the serial number of a device.
[Status]	Displays icons depending on status information (errors, warnings or notifications) sent by a device.
② [Power]	Displays the power status of a device.  : Standby status  : Power supply is on  : Power supply is being cooled  : No information has been acquired from the device
[Main Version]*	Displays the version of the device's main microcomputer.
[Sub Version]*	Displays the version of the device's sub microcomputer.
[Memo 1]*	Displays the [Memo 1] registered at register device. (page 40)
[Memo 2]*	Displays the [Memo 2] registered at register device. (page 40)

\* : You can display it by descending order or ascending order.

## Displaying a List of Registered Devices (Overview screen)

### Saving Device Management Information

Saves management information for all registered devices.

**1** Click [Detailed/Overview] to switch to the Overview screen.

**2** Click [Save List].

Device management information will be saved as a compressed CSV file.

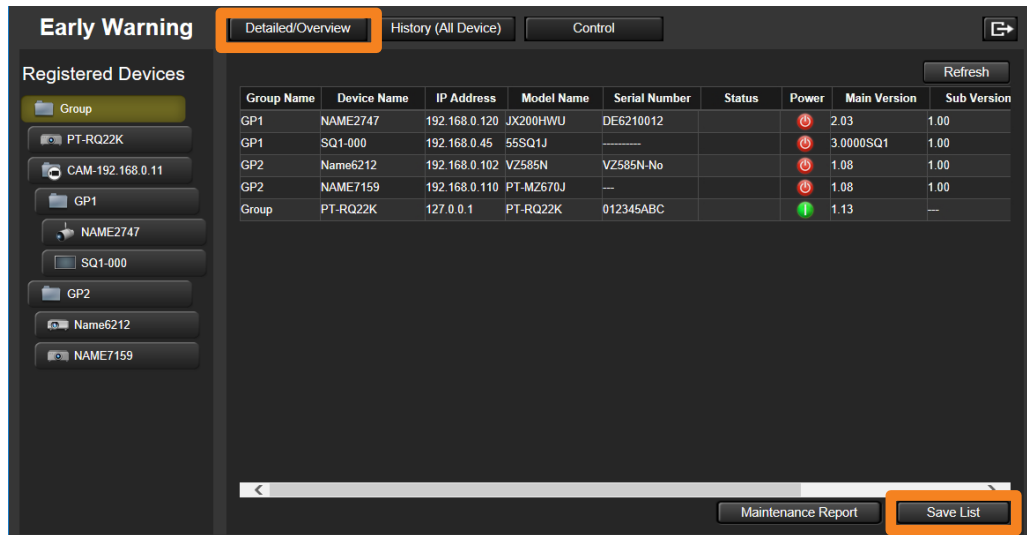

### Example showing saved data

	A	B	C	D	E	F	G	H	I	J	K
1	Application Name	Early Warning									
2	Version	Ver.*,*,****									
3	Stored	*/**/**** 12:00:58 PM									
4											
5	ReportTitle	Asset Management Information									
6											
7		Group Name	Device Name	IP Address	Model Name	Serial Number	Set Runtime	Main Version	Sub Version	Memo1	Memo2
8	1	Tower2-1F	DZ21 K	192.168.10.1	DZ1 2000-TEST	SHE330006	1200	1.01	1.00		
9	2	Tower2-1F	DZ21 K	192.168.10.2	DZ1 2000-TEST2	SHE330007	115	1.01	1.00		
10	3	Tower2-2F	DZ6700	192.168.10.3	D67-001	AB1 234567	210	1.03	1.00		
11	4	Tower2-2F	DW6300	192.168.10.4	DW63-001	AB1 234568	350	1.02	1.00		
12	5	Tower2-3F	EZ570	192.168.10.5	EZ570-001	SH1 15001	4570	1.02	1.00		
13	6	Tower2-3F	EZ570	192.168.10.6	EZ570-002	AB1 234567	1234	1.02	1.00		
14	7	Tower3-1F	FW430	192.168.10.7	FW43-001	AB1 234568	1547	1.01	1.00		
15	8	Tower3-1F	FX400	192.168.10.8	FX-TEST	AB1 234569	552	1.01	1.00		
16	9	Tower3-2F	F300NT	192.168.10.9	F300-01	AB1 234570	554	1.03	1.00		
17	10	Tower3-2F	F300NT	192.168.10.10	F300-02	AB1 234571	122	1.04	1.00		

### Notes

- [Save List] can only be used when viewed with Microsoft Edge on a Windows OS. The [Save List] button cannot be clicked when viewed with an OS other than Windows OS such as an iOS or Android.



## Displaying a List of Registered Devices (Overview screen)

## Displaying or Saving a Maintenance Report

Use this procedure to display or save maintenance information for registered devices by specifying the items to display, interval, and cycle count.

### Preparation:

- To display or save maintenance reports for a Basic information model device, you must configure the maintenance parts settings for the device beforehand. (page 218)

**1** Click [Detailed/Overview] to switch to the Overview screen.

**2** Click [Maintenance Report].

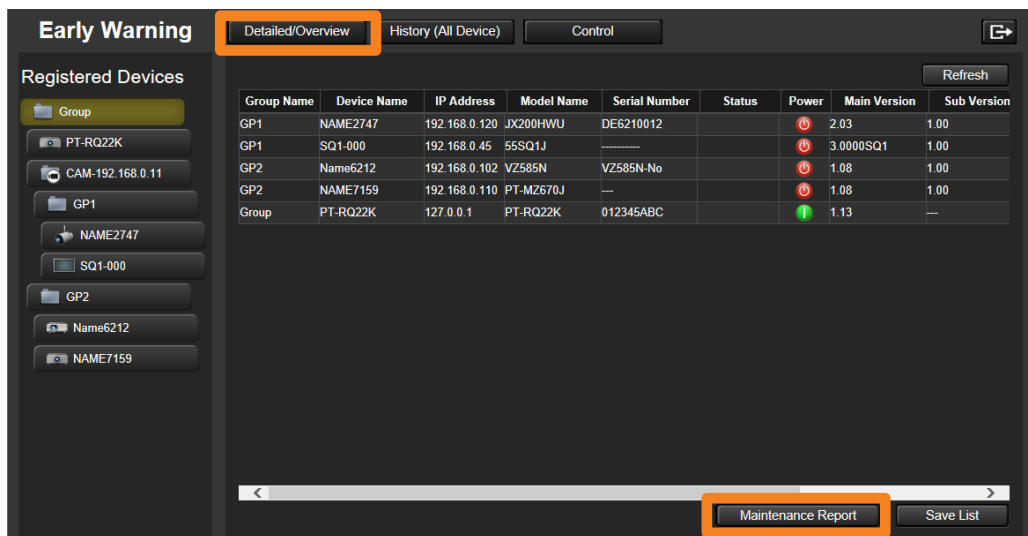

**3** Place a check on the items of ① that you want to output, and set the interval or frequency.

- If you click [Cancel] (②), it will return to the Overview screen of the device.

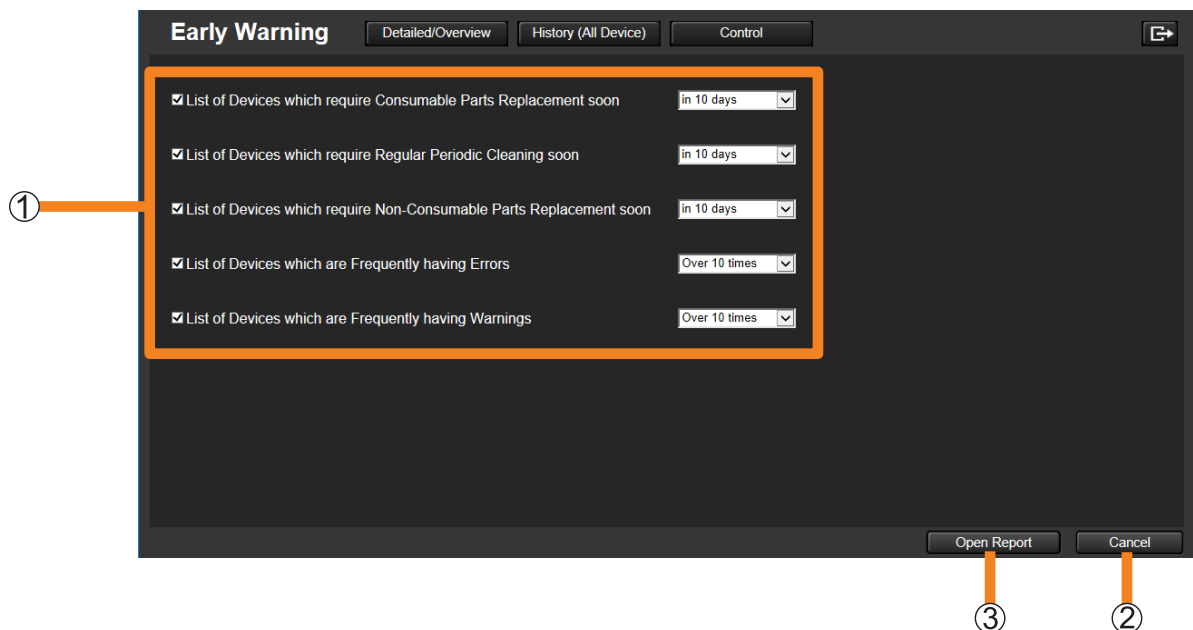

## Displaying a List of Registered Devices (Overview screen)

<b>[List of Devices which require Consumable Parts Replacement soon]</b>	Displays the time to replace the consumable parts of registered devices.	Sets the number of days beforehand to display a device's replacement or cleaning time. [in 10 days] / [in 20 days] / [in 30 days] / [in 60 days] / [in 90 days]
<b>[List of Devices which require Regular Periodic Cleaning soon]</b>	Displays the time to perform regular periodic cleaning of registered devices.	
<b>[List of Devices which require Non-Consumable Parts Replacement soon]</b>	Displays the time to replace the non-consumable parts of registered devices.	
<b>[List of Devices which are Frequently having Errors]</b>	Extract and display the devices in which an error occurred more than the specified number of times.	Sets the number of times an error or warning occurs on a device before displaying the device. [Over 10 times] / [Over 30 times] / [Over 50 times] / [Over 90 times]
<b>[List of Devices which are Frequently having Warnings]</b>	Extract and display the devices in which warnings occurred more than the specified number of times.	

### 4 Click [Open Report] (③).

A maintenance report based on the configured settings will be displayed.

### 5 Click [Save Report].

The maintenance report is saved as a compressed CSV file.

- Click [Cancel] if you decide not to extract the report.

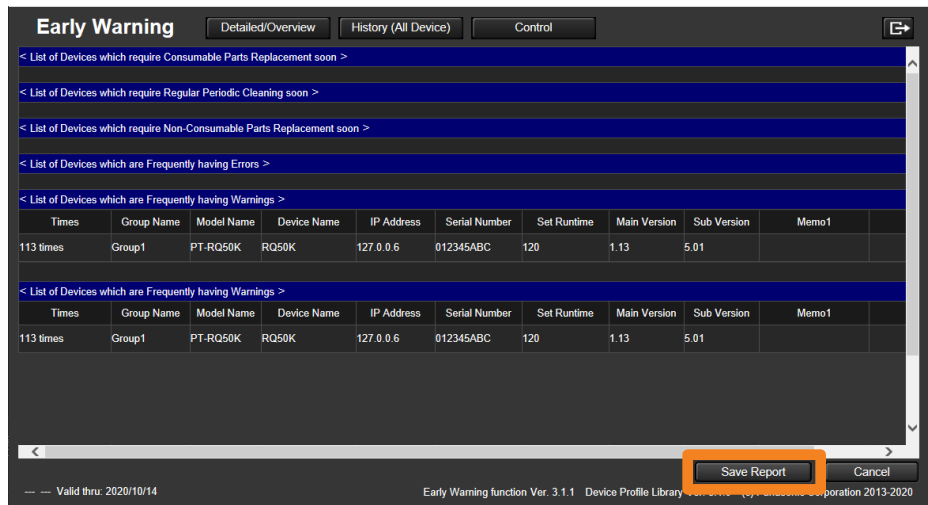

## Displaying a List of Registered Devices (Overview screen)

### ■ Example showing saved data

```

Application Name,Early Warning
Version,Ver.*.*.*
Stored,**/**/**** 8:12:55 PM

< List of Devices which require Consumable Parts Replacement soon >,
----- Lamp1 -----
Emergency,Group Name,Model Name,Device Name,IP Address,SerialNumber,Set Runtime,Main Ver.,Sub Ver.,Memo1...
in 10 days,Group,DZ13K,DZ13K-001,***.***.***.***,012345ABC,2240,1.02,,,2100,200

< List of Devices which require Regular Periodic Cleaning soon >
----- Filter -----
Emergency,Group Name,Model Name,Device Name,IP Address,SerialNumber,Set Runtime,Main Ver.,Sub Ver.,Memo1...
in 10 days,Group,DZ13K,DZ13K-001,***.***.***.***,012345ABC,2240

< List of Devices which require Non-Consumable Parts Replacement soon >
----- Exhaust FAN(R) -----
Emergency,Group Name,Model Name,Device Name,IP Address,SerialNumber,Set Runtime,Main Ver.,Sub Ver.,Memo1...
in 30 days,Group,DZ13K,DZ13K-001,***.***.***.***,012345ABC,2240,1.02

< List of Devices which Frequently having Errors >
Emergency,Group Name,Model Name,Device Name,IP Address,SerialNumber,Set Runtime,Main Ver.,Sub Ver.,Memo1...
123times,Group,DZ13K,DZ13K-001,***.***.***.***,012345ABC,2240,1.02

< List of Devices which Frequently having Warnings >
Emergency,Group Name,Model Name,Device Name,IP Address,SerialNumber,Set Runtime,Main Ver.,Sub Ver.,Memo1...
52times,Group,DZ13K,DZ13K-001,***.***.***.***,012345ABC,2240,1.02

```

### Notes

- [Save Report] can only be used when viewed with Microsoft Edge on a Windows OS. The [Save Report] button cannot be clicked when viewed with an OS other than Windows OS such as an iOS or Android.

## Confirming Device History Information

[History (All Device)]

The status information (errors, warnings and notifications) and history for all devices registered in the monitoring and control terminal are displayed.

- History information is saved as a compressed CSV file. (page 192)

### 1 Click [History (All Device)].

- Clicking a notification line will open the status screen for the device that was clicked.

Date	Group Name	Device Name	IP Address	Model Name	Serial Number	Status	Notice
7/3/2018 3:31:30 PM	Group	DZ21K-0001	192.168.10.1	DZ21K	3DF245Y64	✖	Intake Air High Temperature Error
7/3/2018 3:31:30 PM	Group	DZ21K-0001	192.168.10.1	DZ21K	3DF245Y64	⚠	Intake1 FAN Error
7/3/2018 3:31:30 PM	Group	DZ21K-0001	192.168.10.1	DZ21K	3DF245Y64	⚠	Filter Clogging Up Early Warning
7/3/2018 3:31:30 PM	Group	DZ21K-0001	192.168.10.1	DZ21K	3DF245Y64	ℹ	Notice: Video stopping
7/3/2018 3:31:30 PM	Inside	EF1-0015	192.168.10.15	32EF1J	AODJ3849D	ℹ	Notice: Video stopping
7/3/2018 3:31:30 PM	Group-B	MZ670-0012	192.168.10.12	PT-MZ670	AUD9302JE	⚠	Notice: Polarizer (OUT/G) life
7/3/2018 3:31:30 PM	Group-B	MZ670-0012	192.168.10.12	PT-MZ670	AUD9302JE	⚠	LCD-R FAN Error
7/3/2018 3:31:30 PM	Group-B	MZ670-0012	192.168.10.12	PT-MZ670	AUD9302JE	ℹ	Notice: Video stopping
7/3/2018 3:31:30 PM	Others(PJLink)	LB360-0009	192.168.10.9	LB360	---	⚠	LIGHT Warning
7/3/2018 3:31:30 PM	Group-B	RQ13K-0004	192.168.10.4	RQ13K	BOJ4V3CCY	✖	DMD Low Temperature Error
7/3/2018 3:31:30 PM	Group-B	RQ13K-0004	192.168.10.4	RQ13K	BOJ4V3CCY	✖	Exhaust Air High Temperature Error
7/3/2018 3:31:30 PM	Group-B	RQ13K-0004	192.168.10.4	RQ13K	BOJ4V3CCY	✖	DMD High Temperature Error
7/3/2018 3:31:30 PM	Group-B	RQ13K-0004	192.168.10.4	RQ13K	BOJ4V3CCY	✖	Intake Air High Temperature Error
7/3/2018 3:31:30 PM	Group-B	RQ13K-0004	192.168.10.4	RQ13K	BOJ4V3CCY	⚠	Filter Clogging Up Early Warning
7/3/2018 3:31:30 PM	Others(PJLink)	EB-1985WU-0010	192.168.10.10	EB-1985WU	---	✖	Temperature Error
7/3/2018 3:31:30 PM	Outside	LFX60U-0007	192.168.10.7	47LFX60U	U1B3290C	✖	FAN Error
7/3/2018 3:31:30 PM	Outside	LFX60U-0007	192.168.10.7	47LFX60U	U1B3290C	⚠	Internal Temperature1 Warning
7/3/2018 3:31:30 PM	Group	D12000-0003	192.168.10.3	D12000	P43GLL21Q	ℹ	Notice: Filter life

- ①: If a notification is unread, a check mark is added to its check box, and each type of notification is displayed in a different color. When you remove the check mark to indicate that it was read, the color coding is canceled.
- (Red): Error
  - (Yellow): Warning
  - (Blue): Notification
- ② Items: The following information is displayed for the device where the error, warning or notification occurred.

[Date]	Displays the date of occurrence.
[Group Name]	Displays the group name of the device. (If the group folder of the tree pane is  , the camera name set at the time of network camera registration or CAM-XXX (XXX: network camera's IP address))
[Device Name]	Displays the device name.
[IP Address]	Displays the device's IP address.
[Model Name]	Displays the device model name.
[Serial Number]	Displays the serial number of a device.
[Status]	Displays the type of notification as an icon. ✖ : Error ⚠ : Warning ℹ : Notification
[Notice]	Displays the contents of the notification.

## Confirming Device History Information ([History (All Device)])

## ③ [Result]:

If it is detected that video has stopped, a video stop detection notification is displayed in the [Notice] column and a [Result] button to the right of it. Click the button to check the video stop status.

- The image displayed is a composite of the image at the time of video stop detection and the previously set output image determination area (page 202).

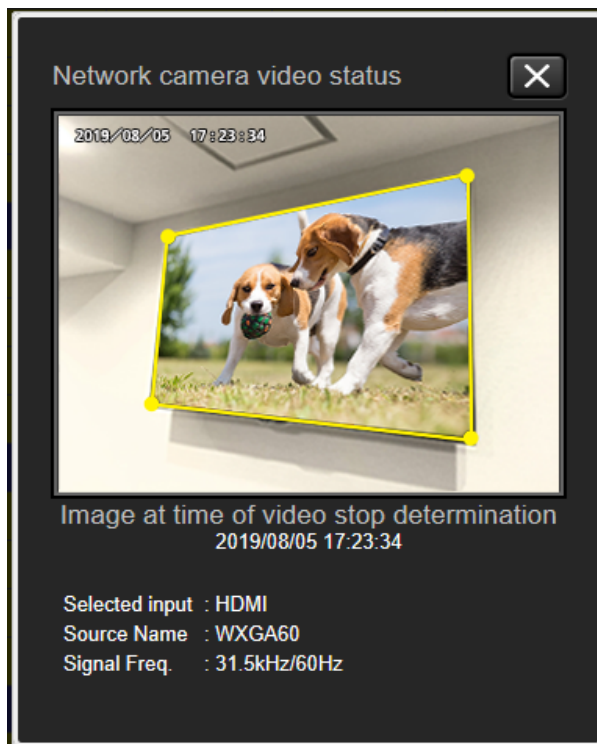
**Notes**

- History can display up to 2,000 instances from the most recent data.
- You can select from 500, 1,000, or 2,000 for the number of system history entries that can be saved. (page 230)
- Clicking the history information of a device whose registration has been deleted will not open the status screen of that device.
- Serial numbers are not included in the history data for devices registered as Basic information model devices.

## Confirming Device History Information ([History (All Device)])

### Saving History Information

1 Click [History (All Device)] to display the history screen.

2 Click [Save History].

The history information is saved as a compressed CSV file.

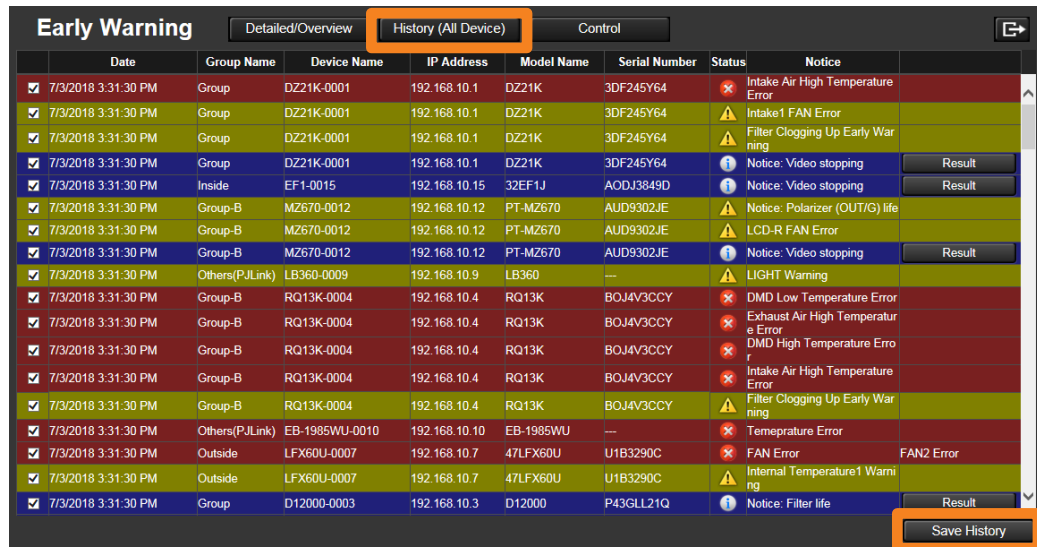

### Example showing saved data

```

Application Name,Early Warning Software
Version,Ver.1.1
Stored,*/*/* 6:48:42 PM

Date,Group Name,Device Name,IP Address,Model Name,Serial Number,Status,Detail
*/*/* 6:17:01 PM,"Group","DZ570-0002",192.168.0.4,DZ570,012345ABC,Warning,"Projector LAN Connection Error",
*/*/* 6:17:01 PM,"Group","DZ21K-0001",192.168.0.3,DZ21K,AB1234567,Warning,"Projector LAN Connection Error",
*/*/* 4:34:16 PM,"Group","DZ21K-0001",192.168.0.3,DZ21K,AB1234567,Error,"Internal Error","FPGA3 Configuration Error"
*/*/* 4:34:16 PM,"Group","DZ21K-0001",192.168.0.3,DZ21K,AB1234567,Error,"Internal Error","FPGA1/2 Configuration Error"
*/*/* 4:34:16 PM,"Group","DZ21K-0001",192.168.0.3,DZ21K,AB1234567,Error,"FAN Error","Color Prism3 FAN Error"
*/*/* 4:34:16 PM,"Group","DZ21K-0001",192.168.0.3,DZ21K,AB1234567,Error,"FAN Error","Color Prism2 FAN Error"
*/*/* 4:34:16 PM,"Group","DZ21K-0001",192.168.0.3,DZ21K,AB1234567,Error,"FAN Error","Color Prism1 FAN Error"
*/*/* 4:34:16 PM,"Group","DZ21K-0001",192.168.0.3,DZ21K,AB1234567,Error,"FAN Error","LIGHT3/4 (Right) FAN Error"

:
:
:

*/*/* 3:38:54 PM,"Group","DZ21K-0001",192.168.0.3,DZ21K,AB1234567,Warning,"Intake Air High Temperature Warning",
*/*/* 3:34:42 PM,"Group","DZ21K-0001",192.168.0.3,DZ21K,AB1234567,Error,"FAN Error","Exhaust1 FAN Error"
*/*/* 3:33:32 PM,"Group","DZ21K-0001",192.168.0.3,DZ21K,AB1234567,Error,"FAN Error","Exhaust1 FAN Error"
*/*/* 3:33:32 PM,"Group","DZ21K-0001",192.168.0.3,DZ21K,AB1234567,Notice,"Notice: LIGHT 1 life",
*/*/* 3:33:32 PM,"Group","DZ21K-0001",192.168.0.3,DZ21K,AB1234567,Notice,"Notice: LIGHT 2 life",
*/*/* 3:33:32 PM,"Group","DZ21K-0001",192.168.0.3,DZ21K,AB1234567,Notice,"Notice: LIGHT 3 life",
*/*/* 3:33:32 PM,"Group","DZ21K-0001",192.168.0.3,DZ21K,AB1234567,Notice,"Notice: LIGHT 4 life",
*/*/* 3:31:48 PM,"Group","DZ21K-0001",192.168.0.3,DZ21K,AB1234567,Error,"FAN Error","Exhaust1 FAN Error"
    
```

### Notes

- [Save History] can only be used when viewed with Microsoft Edge on a Windows OS. The [Save History] button cannot be clicked when viewed with an OS other than Windows OS such as an iOS or Android.

## Controlling Devices ([Control])

You can perform off/on controls for the power, shutter function, and AV muting function on registered devices individually or by groups.

- Functions other than these should be controlled from the software side on the monitoring and control terminal. (page 112)

### 1 Click [Control] to display the device control screen.

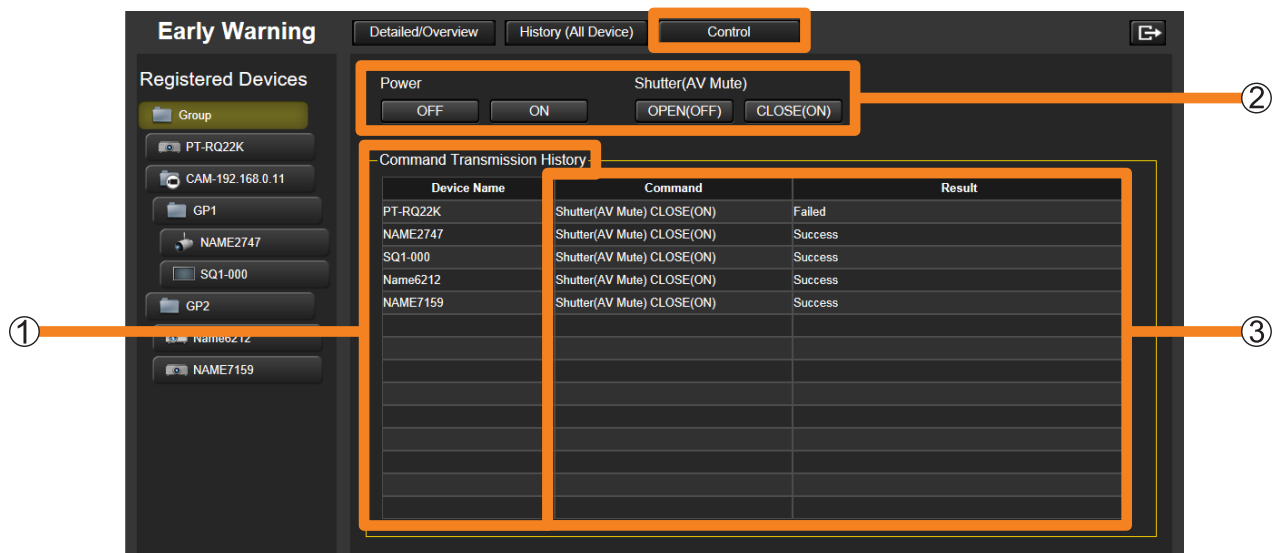

### 2 From the tree view area, select the devices or groups you want to control.

The names of the selected devices will appear under [Device Name] (1) in [Command Transmission History].

### 3 Select the operation you want to perform from (2).

The selected control command is sent to each device.

③ **[Command]:** The control command that was sent

**[Result]:** Displays the result of sending the command. One of the following results will be shown.

<b>[Success]</b>	Transmission of the control command was successful.
<b>[Failed]</b>	Transmission of the control command failed. Check the status of the device.
<b>[Failed. Busy with another control task.]</b>	Data update or other processes were in progress on the device. Wait a moment before performing the operation again.
<b>[Failed. Different device has been detected.]</b>	A device that differs from registered device is connected. Check the device.

#### Notes

- Even if a control command is successfully sent to a device, the device's status screen will not be updated until a data update is performed. If you want to check the status of the device immediately, click [Refresh] in the device's status screen. The devices' information will be updated to the most recent state.
- When a power-on operation is performed for a projector, it may take some time for it to be reflected on the status screen as it takes some time for the lamps to turn on.

## Displaying Error/Warning and Notice Details

Use the steps below to display detailed information on the events a device reports (error, warning or notification details) and measures to handle them.

- 1 Click [Detailed/Overview] to display the detail screen and select the device where the event occurred from the tree pane.

The screenshot shows the 'Early Warning' interface with the 'Detailed/Overview' tab selected. The device 'RQ50K\_001' is highlighted in the tree pane. The main area displays various status and environmental information:

- Status:** Group Name: CAM-192.168.0.10, IP Address: 192.168.0.217, Shutter(AV Mute): OPEN(OFF), Model Name: PT-RQ50K, Serial Number: SN1234567, Selected input: HDMI, Power: ON, Power on count: 20times, Source Name: WXGA60, Selected LIGHT: ---, Operating Mode: ---, Signal Freq: 31.5KHz/60Hz, Main/Sub Version: 1.08/1.00, Network Version: 2.34, AC Voltage: 100V.
- Environment Info:** Intake temperature: 39degC / 102degF, Exhaust temperature: 60degC / 140degF, DMD-R temperature: 81degC / 177degF.
- Power on hours:** Total Power on hours: 3520H. A bar chart shows power on hours over a 24-hour period.
- Other indicators:** LIGHT1 and LIGHT2 both at 200H. Exhaust fans (Exhaust-1, Exhaust-2, Exhaust-3) are all in 'Good' status.

- 2 Click the [Warning] tab.

This tab provides details on the reports from the selected device and how to handle them. Take the required measures in accordance with the information in [Suggested Action].

The screenshot shows the 'Early Warning' interface with the 'Warning' tab selected. The device 'RQ50K\_001' is highlighted in the tree pane. The main area displays a list of warnings and notices:

Status	Notice	Suggested Action
Warning	Exhaust1 FAN Error	Ask your dealer to inspect FAN motor. Exhaust-1 FAN level exceeds rated value.
Warning	Color Prism1 FAN Error	Ask your dealer to inspect FAN motor. Color Prism-1 FAN level exceeds rated value.
Warning	Circuit Intake1 FAN Error	Ask your dealer to inspect FAN motor. Circuit Intake 1 FAN level exceeds rated value.
Warning	B-LD1-1/2/3/4 FAN Error	Ask your dealer to inspect FAN motor. B-LD1-1/2/3/4 FANlevel exceeds rated value.
Notice	Notice: Video stopping	The camera image may have stopped. Confirm the Condition of device. Confirm the camera connection. <span>Result</span>



## Displaying Error/Warning and Notice Details

## ■ Overview of screen

Group Name	Device Name	IP Address	Model Name	Serial Number
CAM-192.168.0.10	RQ50K_001	192.168.0.217	PT-RQ50K	SN1234567
Status	Notice	Suggested Action		
⚠	Exhaust1 FAN Error	Ask your dealer to inspect FAN motor. Exhaust-1 FAN level exceeds rated value.		
⚠	Color Prism1 FAN Error	Ask your dealer to inspect FAN motor. Color Prism-1 FAN level exceeds rated value.		
⚠	Circuit Intake1 FAN Error	Ask your dealer to inspect FAN motor. Circuit Intake1 FAN level exceeds rated value.		
⚠	B-LD1-1/2/3/4 FAN Error	Ask your dealer to inspect FAN motor. B-LD1-1/2/3/4 FANlevel exceeds rated value.		
ℹ	Notice: Video stopping	The camera image may have stopped. Confirm the Condition of device. Confirm the camera connection.		<input type="button" value="Result"/>

## ① Device information:

[Group Name]	Displays the group name of a device. (If the group folder of the tree pane is  , the camera name set at the time of network camera registration or CAM-XXX (XXX: network camera's IP address))
[Device Name]	Displays the device name.
[IP Address]	Displays the device's IP address.
[Model Name]	Displays the device model name.
[Serial Number]	Displays the serial number of a device.

## ② Notices and suggested actions:

[Status]	Displays icons depending on status information (errors, warnings or notifications) sent by a device.
[Notice]	Displays information on error, warnings or notifications.
[Suggested Action]	Provides measures to handle error, warnings or notifications.

## Displaying Error/Warning and Notice Details

## Using a Network Camera to Detect the Presence of an Output Image

You can use a network camera installed for video surveillance of a device and use it to receive notifications when a video being displayed stops.

### Preparation:

- Link a device to a network camera. (page 56).
- Set the video stop determination for the device registered to a network camera (page 202).

### To display stopped video detection:

- Display notifications on the monitoring and control functions (page 206).
- Confirm the detection result on your web browser (page 206).

### Notes

- The valid resolution size of an image acquired from a network camera at the time of video stop determination is as follows.  
Maximum: 4,096 (horizontal) × 2,160 (vertical)  
Minimum: 640 (horizontal) × 360 (vertical)

## Setting the video stop determination of a device linked to a network camera

### 1 Start the software. (page 23)

### 2 From the tree pane of the <Device Monitoring> window, select the device icon that is linked to the network camera for which you want to perform video stop determination, then right-click it and select [Property].

- To link a device to a network camera, move the device icon below the network camera. (page 56)

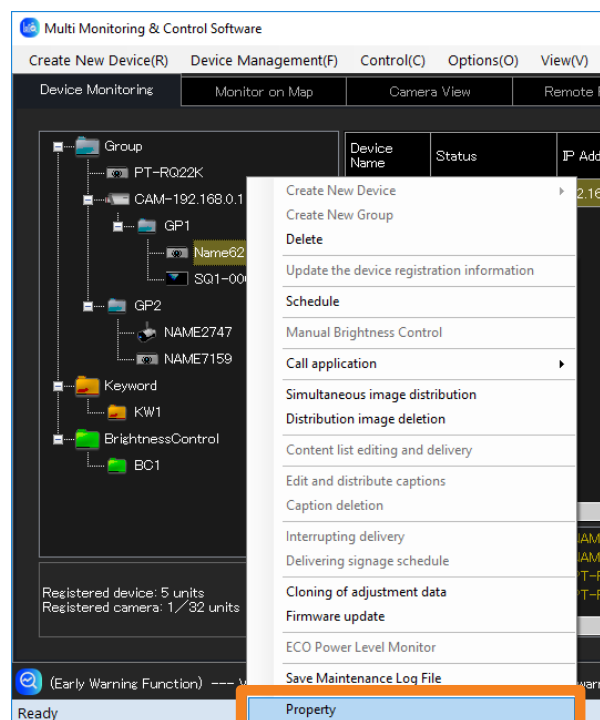

## Displaying Error/Warning and Notice Details

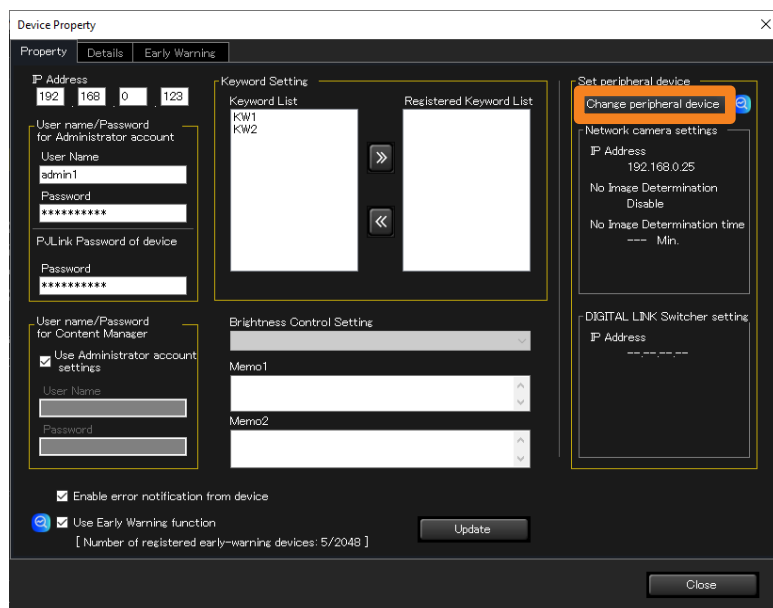
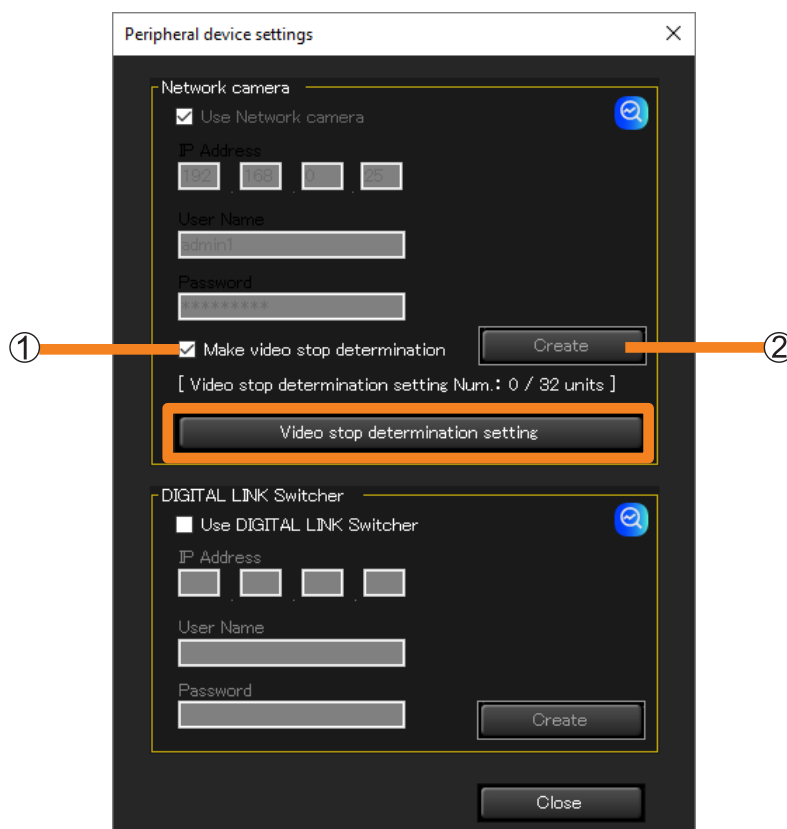
**3** Click [Change peripheral device].**4** Select the check box [Make video stop determination] (①) and click [Create] (②) → [Video stop determination setting].**Notes**

- When video stop determination is performed, it will periodically acquire JPEG images from the network camera.
- The maximum number of video stop determination settings is 32.
- To maximize the video stop determination's performance, it is recommended to set a high JPEG quality and resolution on the network camera.

## Displaying Error/Warning and Notice Details

### 5 Configure detection of interruption of output image.

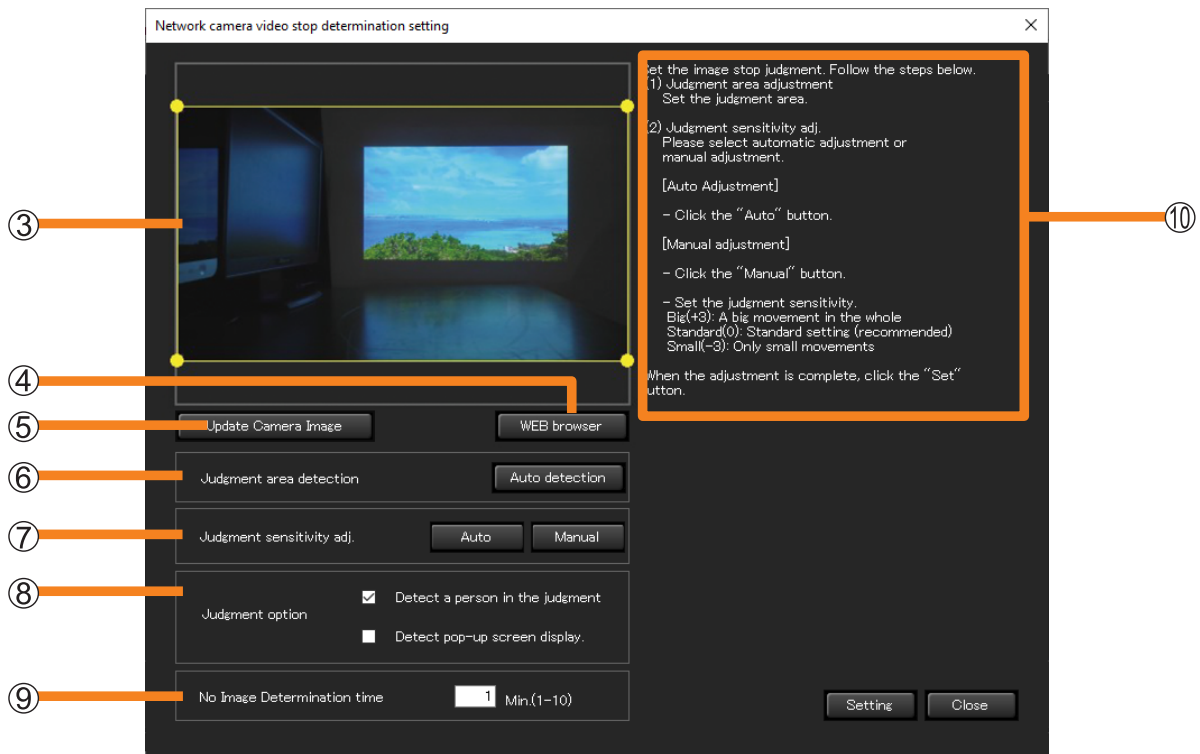

<p>③ <b>Detection area rectangle setting</b></p>	<p>A linked camera's video will be displayed. Move the dots "●" at the four corners to set the area to determine.</p> <ul style="list-style-type: none"> <li>• Set 10% or more for each vertical and horizontal length of the screen.</li> </ul>
<p>④ <b>[WEB browser]</b></p>	<p>You can display the setting window of the network camera.</p> <ul style="list-style-type: none"> <li>• It may be required to install the necessary plug-in software to display the setting window of the network camera depending on your environment. Follow the on-screen instructions and install the plug-in software.</li> </ul>
<p>⑤ <b>[Update Camera Image]</b></p>	<p>Every time you click it, the latest image of the linked camera is displayed.</p>
<p>⑥ <b>[Judgment area detection]</b></p>	<p>When [Auto detection] is clicked, the judgment area is automatically detected from the image or blue background image displayed in the screen. Confirm the display content then click [Auto detection].</p>
<p>⑦ <b>[Judgment sensitivity adj.]</b></p>	<p>Set determination sensitivity at the time of video determination stop.</p> <p><b>[Auto]:</b> Automatically adjust determination sensitivity by using the camera's video displayed within the determination area as a standard.</p> <p>① <b>Click [Auto].</b></p> <ul style="list-style-type: none"> <li>• A confirmation message will be displayed on whether or not there is movement in the video within the determination area.             <ul style="list-style-type: none"> <li>- [Yes]: When sensitivity adjustment will be performed for video contents with movement.</li> <li>- [No]: When performing sensitivity adjustment on video content (excluding signage switching scenes) with no movement.</li> </ul> </li> </ul> <p>② <b>Click [Start].</b> Automatic adjustment of the determination sensitivity will begin. It will take approximately 1 minute to adjust.</p> <p><b>[Manual]:</b> Manually adjust determination sensitivity by using the camera's video displayed within the determination area as a standard.</p>

## Displaying Error/Warning and Notice Details

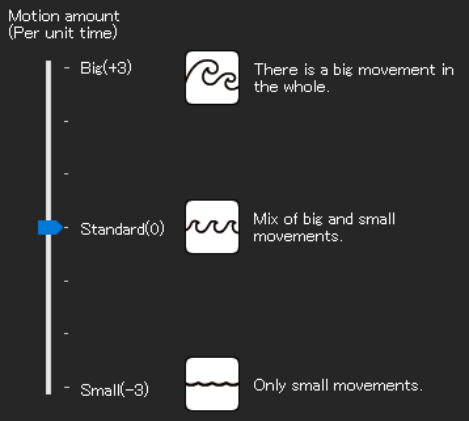
⑧ [Judgment option]	<p>Judgment conditions at the time of video stop determination can be selected.</p> <p><b>[Detect a person in the judgment]:</b> When you place a check, it decreases situations wherein video stop determination is performed incorrectly due to people who enter the judgment area.</p> <p><b>[Detect pop-up screen display]:</b> When you place a check, and a pop-up screen is displayed due to a Windows Update etc. during determination, it will be notified as a warning message.</p>
⑨ [No Image Determination time]	<p>Set the duration of continuous stopped video before a notification is sent from 1 to 10 minutes (in 1 minute increments) starting from the time the video interruption is detected.</p>
⑩ Manual adjustment display	<p>It will only be displayed when [Manual] is selected at [Judgment sensitivity adj.] (⑦). Set the determination sensitivity with the following as a reference.</p>  <ul style="list-style-type: none"> <li>• <b>[Big(+3)]:</b> Set when a video with only large movements is running</li> <li>• <b>[Standard(0)]: Normal setting (Video with a mix of many/few movements)</b></li> <li>• <b>[Small(-3)]:</b> Set when a video with only small movements is running</li> </ul>

**6 Click [Setting].**

When the “setting successful” message is displayed, click [OK].

**Notes**

- For video stop determination, images are acquired from the network camera at intervals of 12 seconds.
- If the network camera setting window is not being displayed even if the plug-in software required at [WEB browser] is installed, perform network camera setting from the WEB browser of your computer.
- In [Judgment area detection], the detection accuracy improves more for images shot from the front.
- In [Judgment area detection], detection may fail depending on the image. In that case, manually select it. (Example: Images that do not fit in the camera, images that have a small contrast difference with its surroundings, and when there are things in the surroundings of the image etc.)
- [Judgment option] (⑧) can be checked for the OS 64-bit version.

## Displaying Error/Warning and Notice Details

### Display notifications on the monitoring and control functions

Upon notification that the image output has stopped, an icon is displayed in the information display area for the corresponding device.

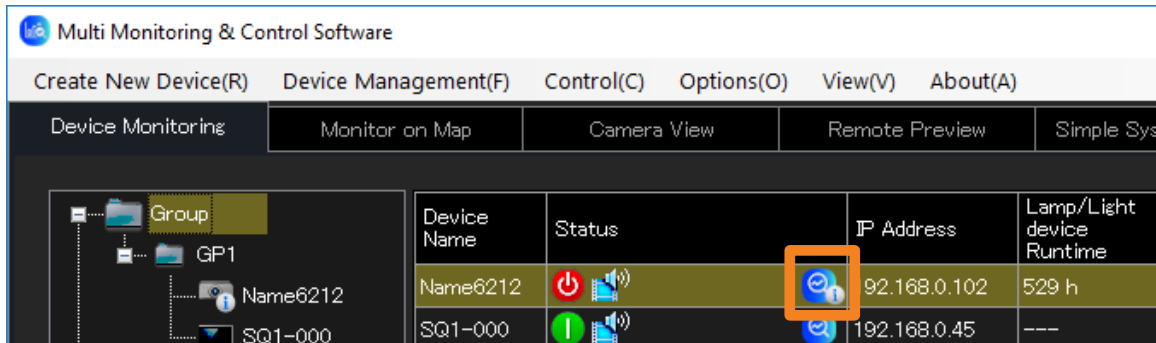

### Confirm the detection result on your web browser

**1** Log in to the early warning from your web browser. (page 35)

**2** Click the [Warning] tab, and then click [Result] (①).

If there is no notification that the image output has stopped, [Result] (①) will not be displayed.

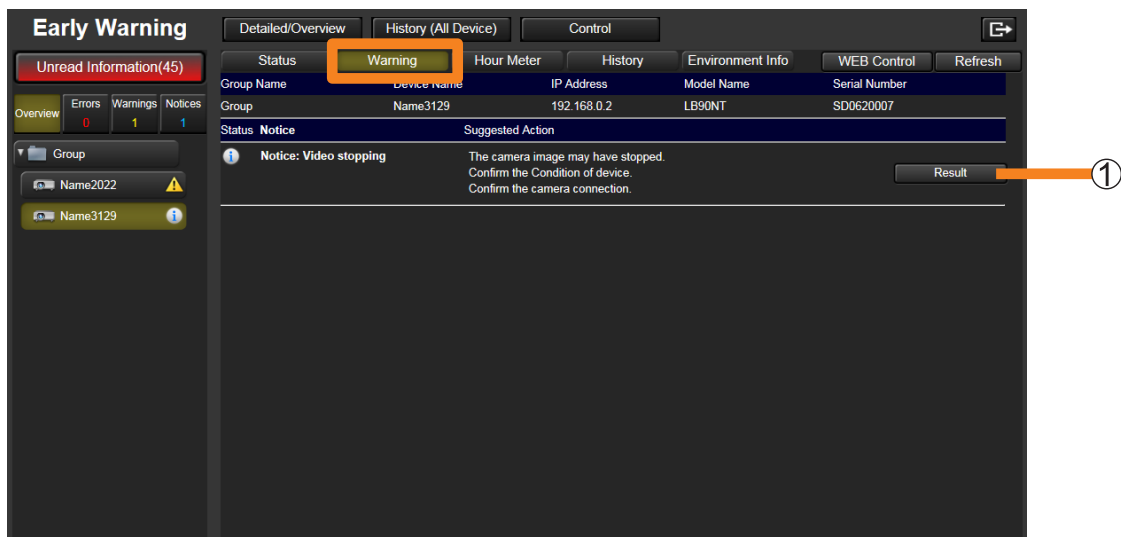

## Displaying Error/Warning and Notice Details

### 3 View the notification details.

- Depending on the network connection status, it may take some time to display.
- Click ② to close the video status confirmation screen.

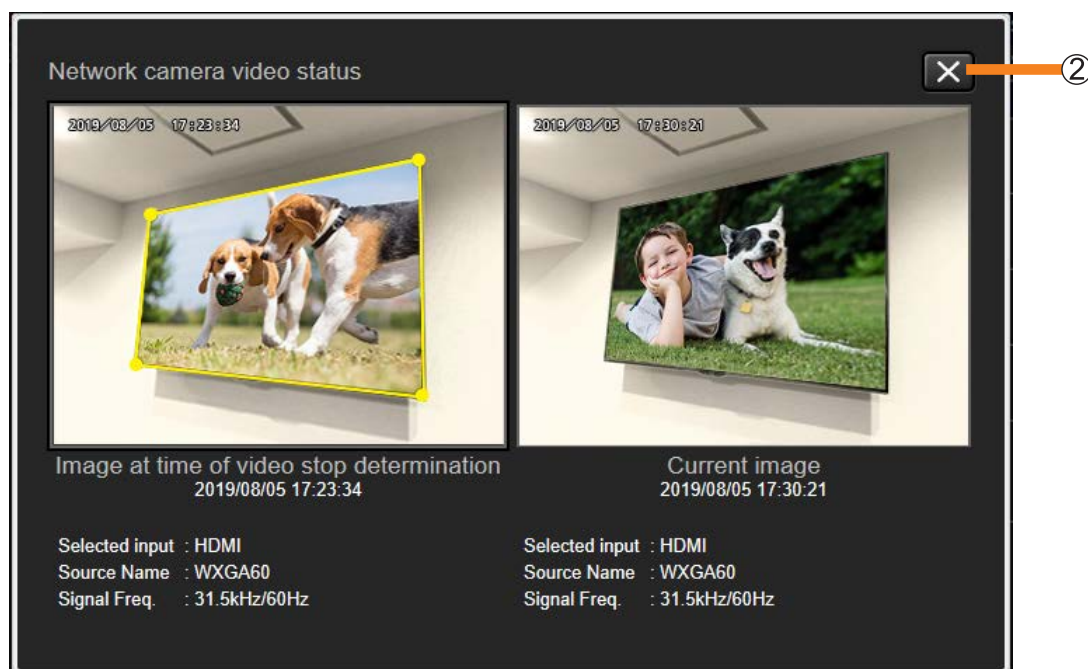

#### Notes

- When a moving object such as a person is captured in the designated area for video stop determination, the movement may be detected and video stop determination may not be properly detected. Background reflections may be particularly noticeable when using a display with a glossy (glare) LCD panel.
- Video images with slow movement or with a small area of movement as well as videos that have a low contrast between the area with movement and its surroundings may not be properly detected.
- Depending on the installation environment of the camera and device, the stopped video detection function may not work properly.
- If there is a problem with detection results, re-adjust the determination sensitivity at [Video stop determination setting]. (page 202)

## Displaying Error/Warning and Notice Details

### Confirming Errors, Warnings and Notification History

Use the steps below to display the history of error, warnings and notifications and when they occurred for a registered device.

- 1 Click [Detailed/Overview] to display the detail screen and select the device where the event occurred from the tree pane.

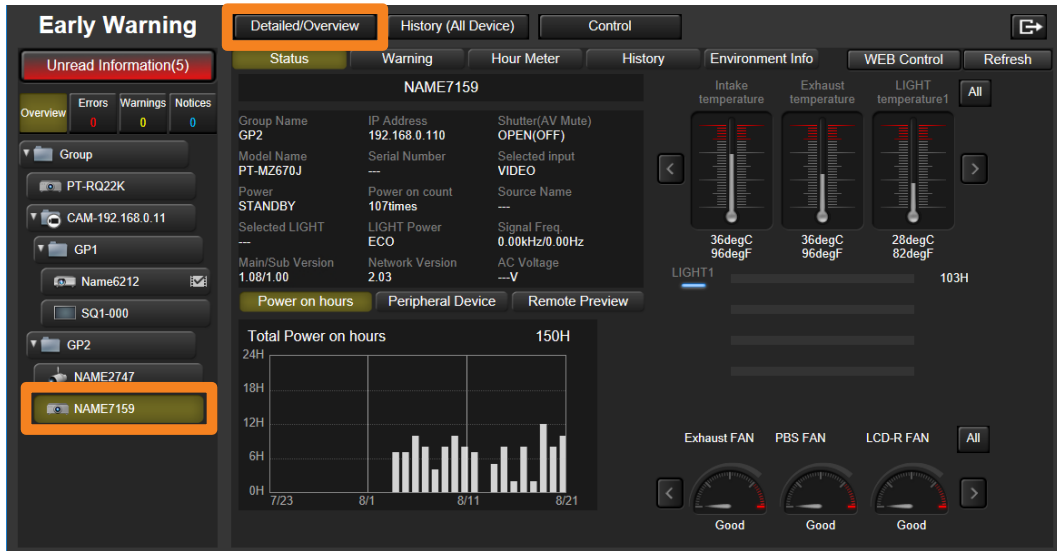

- 2 Click the [History] tab and select [Date] (1).

Messages are displayed in the [Message] field in the data display area to the right.

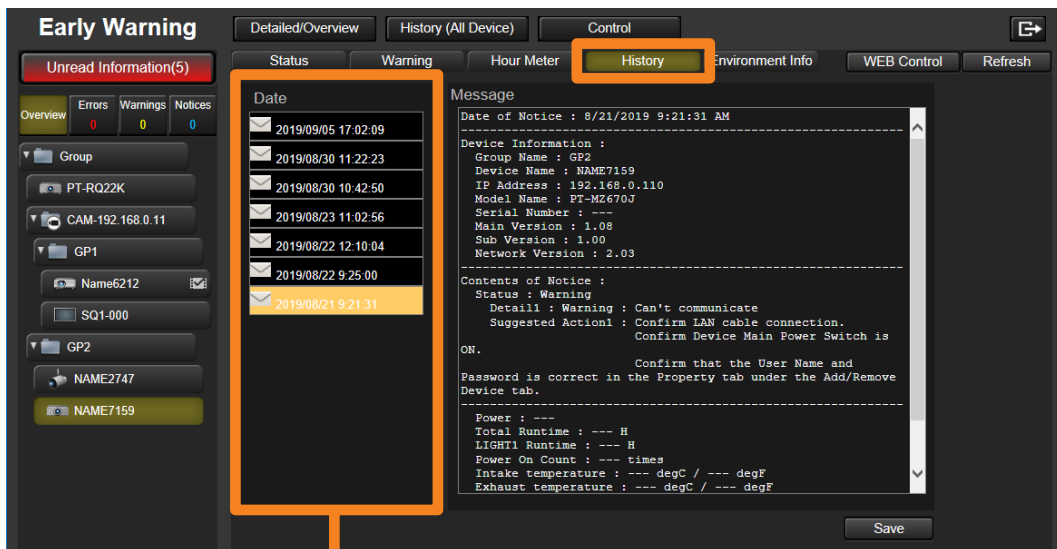

①



## Displaying Error/Warning and Notice Details

## ■ About the screen display

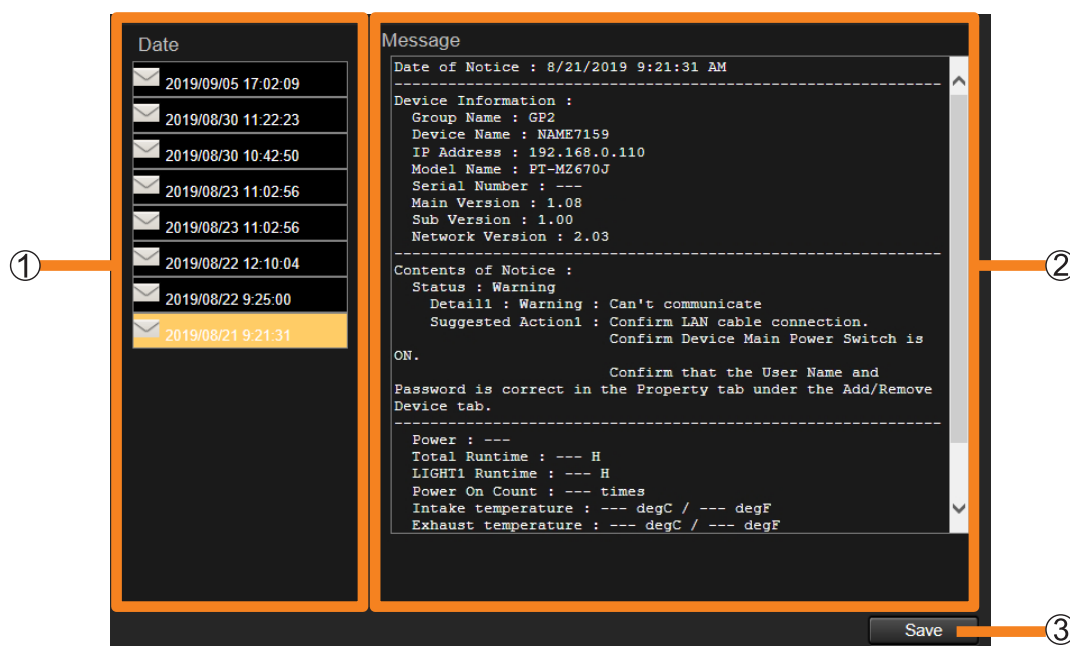

- ① **[Date]**: Displays a list of the dates (history) when error, warnings and notifications have occurred.
- The date icons indicate system log status.
    - : System log available (on a device that supports system log acquisition)
    - : No system log (on a device that does not support system log acquisition)
- ② **[Message]**: Displays the error, warnings and notifications that occurred at the selected date.
- ③ **[Save]**: Saves the message data as compressed files.
- For devices with accessible system logs, text files (.txt) and log files (.log / .bin) are saved as a single compressed file. The file name is made up from the year, month, day, hour, minute, second plus the “serial number”.
  - If no date is selected, this cannot be clicked.

**Notes**

- [Save] can only be used when viewed with Microsoft Edge on a Windows OS. The [Save] button cannot be clicked when viewed with an OS other than Windows OS such as an iOS or Android.
- The system log (log file) is saved in binary format.
- System log information can be checked by service personnel only.
- System logs (log files) are acquired only on devices that support them.
- Although the message field may display a message stating that remaining lamp or light source life is 200 hours, some devices may indicate remaining lamp or light source life as 0 hours. The lamp or light source can be used for the remaining 200 hours.

## Displaying Error/Warning and Notice Details

### ■ Example showing saved data

#### - Projector example

```

Date of Notice : **/**/**** 2:26:23 PM
-----
Projector Information :
Group Name : Group
Projector Name : DZ21K-0001
IP Address : ***.***.***.***
Model Name : DZ21K
Serial Number : AB1234567
Main Ver. : 1.00
Sub Version : 1.00
Network Ver. : 1.03
-----
Contents of Notice :
Status : Error
Detail1 : FAN Error / LIGHT1 FAN Error
Suggested Action1 : Ask your dealer.

Detail2 : FAN Error / Exhaust1 FAN Error
Suggested Action2 : Ask your dealer.
-----
Power : ON
Total Runtime : 123 H
LIGHT1 Runtime : 11 H
LIGHT2 Runtime : 22 H
LIGHT3 Runtime : 333 H
LIGHT4 Runtime : 444 H
LIGHT1 Remain Time : 1111 H
LIGHT2 Remain Time : 2222 H
LIGHT3 Remain Time : 3333 H
LIGHT4 Remain Time : 4444 H
Power On Count : 20 times
Intake Air Temperature : 25 degC / 77 degF
Exhaust Air Temperature : 60 degC / 140 degF
Temperature near Optical Module : 80 degC / 176 degF
-----
Memo :

```

#### - Flat-panel display example

```

Date of Notice : **/**/**** 2:26:23PM
-----
Ddevice Information :
Group Name : Group
Ddevice Name : LFX60-08
IP Address : ***.***.***.***
Model Name : 47LFX60J
Serial Number : 1234567890A
Main Ver. : 1.00
Sub Version : 1.00
Network Ver. : 01.03
-----
Contents of Notice :
Status : Error
Dtail1 : Error: No input signal
Suggested Action1 : Error: A valid input signal has not been detected while specific hours.
Confirm the cabling, source signals, and installation conditions.
Hours can be specified at the display's menu setting.
-----
Power : On
Total Runtime : 1033 H
Power On Count : 147 times
Internal Air Temperature1 : 28 degC / 82 degF
Intake Air Temperature1 : 23 degC / 73 degF
Intake Air Temperature2 : 21 degC / 69 degF
Exhaust Air Temperature1 : 23 degC / 73 degF
Exhaust Air Temperature2 : 21 degC / 69 degF
Panel Temperature1 : 25 degC / 77 degF
-----
Memo :

```

## Checking the Maintenance Timing

The software records the operating status and operating hours of registered devices to predict roughly when consumable parts replacement, regular periodic cleaning and non-consumable parts replacement will be required.

### Preparation:

- To check the maintenance cycle for a Basic information model device, you must configure the maintenance parts settings for the device beforehand. (page 218)

- Click [Detailed/Overview] to display the detail screen and select the device whose maintenance cycle is to be checked from the tree pane.

The screenshot shows the 'Early Warning' interface. The 'Detailed/Overview' tab is active. The tree pane on the left shows a hierarchy: Group > GP1 > Name6212 (highlighted). The main area displays device information for NAME7159, including IP Address (192.168.0.110), Model Name (PT-MZ670J), and Power on count (107times). The 'Hour Meter' tab is selected, showing a bar chart of 'Total Power on hours' for 24H, with a total of 150H. The chart shows power usage over time from 7/23 to 8/21. The right side of the screen shows 'Environment Info' with gauges for Intake temperature (36degC/96degF), Exhaust temperature (36degC/96degF), and LIGHT temperature (28degC/82degF). There are also gauges for Exhaust FAN, PBS FAN, and LCD-R FAN, all showing 'Good' status.

- Click the [Hour Meter] tab.

Detailed information of maintenance cycle will be displayed.

The screenshot shows the 'Early Warning' interface with the 'Hour Meter' tab selected. The 'Maintenance Cycle Editor' is visible, showing settings for 'Average Daily hours of Operation' (set to 1 H) and 'Output Monthly Report'. The 'Consumable Parts Replacement' section includes a 'Filter' (green bar) and 'LIGHT Unit' (556 H). The 'Regular Periodic Cleaning' section includes 'Lens' and 'Filter' (both green bars). The 'Non-Consumable Parts Replacement' section includes 'Polarizer (IN/R)', 'Polarizer (IN/G)', 'Polarizer (IN/B)', 'Polarizer (OUT/R)', 'Polarizer (OUT/G)', 'Polarizer (OUT/B)', and 'LCD Panel (B)', all with green bars and 'Reset' buttons.

## Checking the Maintenance Timing

### ■ About the screen display

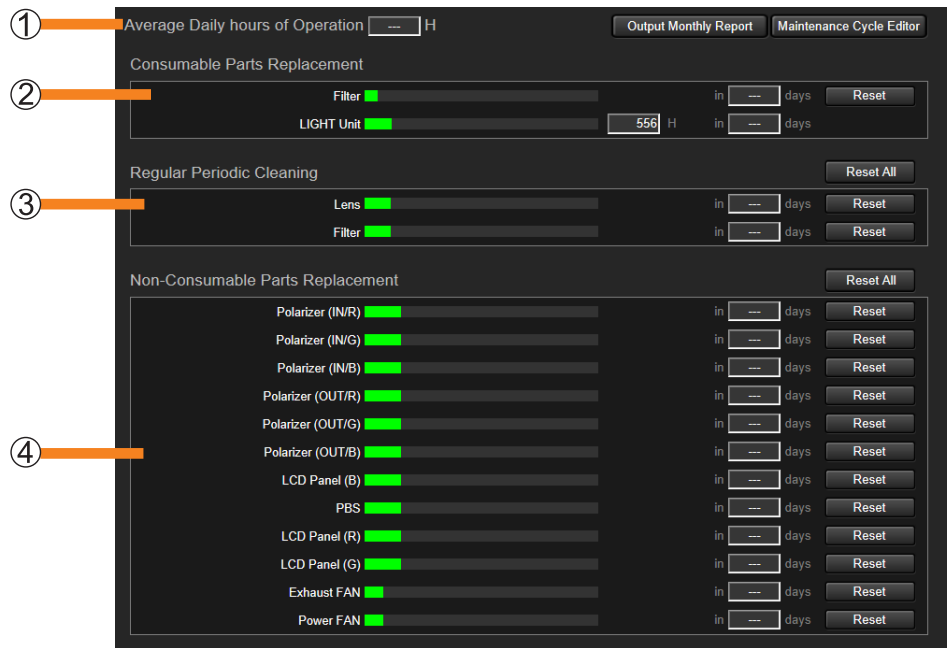

#### ① [Average Daily hours of Operation]:

Uses the past power on hours for a device to calculate and display daily average usage time.

- Data for a minimum of seven days of operation is required to calculate average usage time.
- “---” is displayed when there is not enough power on hour data.

#### ② [Consumable Parts Replacement]:

Displays maintenance cycle information for consumables.

Part name	A graph showing power on hours and the name of the consumable part appear. The state of the part is indicated by the color of the graph. <b>Green:</b> Normal (there is still some time before a notification will be made) <b>Light blue:</b> A notification has occurred (the set number of remaining days has been reached). (page 216) <b>Orange:</b> Warning has occurred (time has come for Consumable Parts Replacement, Regular Periodic Cleaning, Non-Consumable Parts Replacement).
Power on hours	Displays the power on hours for consumables. For projectors that allow setting of the lamp power or lamp output to “ECO” or “low”, the displayed light device runtime is calculated as if the lamp was used with the lamp power or lamp output set to “normal” or “high”.
Predicting when a replacement will be required	Indicates the number of days after which a consumable will have to be replaced. Data for a minimum of seven days of operation is required to calculate the number of days until a warning is displayed. “---” is displayed when there is not enough power on hour data.
[Reset]	Resets the power on hours for consumables. Clicking [Reset] displays a confirmation message. Click [OK] to perform the reset. After processing, the graph and the number of days until parts replacement are initialized. Click [Cancel] if you decide not to reset.

## Checking the Maintenance Timing

### ③ [Regular Periodic Cleaning]:

Displays maintenance information indicating when parts should be cleaned.

<b>Part name</b>	The names of parts that need to be cleaned and a graph showing power on hours appear. The state of the part can be distinguished by the color of the graph. <b>Green:</b> Normal <b>Light blue:</b> A notification was sent <b>Orange:</b> Warning occurrence
<b>Predicting when cleaning will be required</b>	Predicts the number of days after which a part will have to be cleaned. Data for a minimum of seven days of operation is required to calculate the number of days until a warning will be displayed. "---" is displayed when there is not enough power on hour data.
<b>[Reset]</b>	Resets the power on hours for part cleaning. Clicking [Reset] displays a confirmation message. Click [OK] to perform the reset. After processing, the graph and days until periodic cleaning are initialized. Click [Cancel] if you decide not to reset.
<b>[Reset All]</b>	Resets the power on hours for cleaning of all parts. Clicking [Reset All] displays a confirmation message. Click [OK] to perform the reset. After processing, the graph and days until periodic cleaning are initialized. Click [Cancel] if you decide not to reset.

### ④ [Non-Consumable Parts Replacement]:

Displays maintenance information indicating when non-consumable parts should be replaced.

<b>Part name</b>	The names of parts that need to be replaced and a graph showing power on hours appear. The state of the part can be distinguished by the color of the graph. <b>Green:</b> Normal <b>Light blue:</b> A notification was sent <b>Orange:</b> Warning occurrence
<b>Predicting when a replacement will be required</b>	Indicates the number of days after which a part will have to be replaced. Data for a minimum of seven days of operation is required to calculate the number of days until a warning is displayed. "---" is displayed when there is not enough power on hour data.
<b>[Reset]</b>	Resets the power on hours for non-consumable parts replacement. Clicking [Reset] displays a confirmation message. Click [OK] to perform the reset. After processing, the graph and the approximate number of days until non-consumable parts replacement are initialized. Click [Cancel] if you decide not to reset.
<b>[Reset All]</b>	Resets the power on hours for replacement of all non-consumable parts. Clicking [Reset All] displays a confirmation message. Click [OK] to perform the reset. After processing, the graph and the approximate number of days until non-consumable parts replacement are initialized. Click [Cancel] if you decide not to reset.

#### Notes

- This function predicts time for replacements and cleaning based on customer usage and should be used as guidance only.

## Checking the Maintenance Timing

## Output monthly report

The operating environment, history information, error information of the past 30 days, Warning content, notifications and maintenance information of the registered devices will be output as an operation report.

- 1 Click [Detailed/Overview] to display the detail screen and select a device to output maintenance information from the tree pane.

The screenshot shows the 'Early Warning' interface for device NAME7159. The 'Detailed/Overview' tab is active. The 'Hour Meter' tab is selected, and the 'Output Monthly Report' button is highlighted with a circled '1'. The interface displays various status indicators, including 'Unread Information(5)', 'Errors', 'Warnings', and 'Notices'. The 'Hour Meter' section shows a bar chart of power-on hours over a 24-hour period, with a total of 150H. The 'Output Monthly Report' button is located in the top right corner of the 'Hour Meter' section.

- 2 Select the [Hour Meter] tab and click [Output Monthly Report] (①).
  - The operation report from the past 30 days is saved as a compressed CSV file.

The screenshot shows the 'Early Warning' interface for device NAME7159. The 'Hour Meter' tab is selected. The 'Output Monthly Report' button is highlighted with a circled '1'. The interface displays various maintenance information, including 'Average Daily hours of Operation', 'Consumable Parts Replacement', 'Regular Periodic Cleaning', and 'Non-Consumable Parts Replacement'. The 'Output Monthly Report' button is located in the top right corner of the 'Hour Meter' section.

## Checking the Maintenance Timing

### ■ Example showing saved data

	A	B	C	D
1	[Monthly Report]			
2	Period : **/**/****- **/**/****			
3	Device Information			
4	Item	Content		
5	Group Name	Group		
6	Model Name	PT-RQ50K		
7	Device Name	RQ50K-001		
8	IP Address	***.***.***.***		
9	Serial Number	SN1234567		
10	Power On Count		749	
11	Main Version		1.03	
12	Sub Version		1.00	
13	Network Version		1	
14	Set Runtime (H)		3322	
15	Average Daily hours of Operation		11	
16	LIGHT1 Runtime (H):		3322	
17	LIGHT2 Runtime (H):		3322	
18	LIGHT3 Runtime (H):			
19	LIGHT4 Runtime (H):			
20				
21	[Current notification (Error/Warning/Information)]			
22	No.	Status	Content	Remarks
23	1	Error	FAN Error	Exhaust1 FAN Error
24	2	Warning	FAN Warning	Exhaust4 FAN Warning
25	3	Warning	DMD High Temperature Warning	
26	4	Warning	Intake Air High Temperature Warning	
27	5	Warning	Color Prism1 FAN Error	
28				
29	[Errors : Monthly]			
30	Count of occurrences		3	
31	No.	Date	Error Content	Remarks
32	1	**/**/**** 10:02:14 AM	FAN Error	Exhaust1 FAN Error
33	2	**/**/**** 9:56:53 AM	FAN Error	Circuit Intake2 FAN Error
34	3	**/**/**** 9:58:02 AM	FAN Error	Exhaust1 FAN Error
35	4 :	:	:	:
36	5 :	:	:	:
37	6 :	:	:	:

■  
■  
■

### Notes

- [Output Monthly Report] can only be used when viewed with Microsoft Edge on a Windows OS. The [Output Monthly Report] button cannot be clicked when viewed with an OS other than Windows OS such iOS or Android.

## Checking the Maintenance Timing

## Configuring Maintenance Cycle Settings

You can configure the length of time after which consumable parts replacement, parts cleaning, and regular parts replacement should be performed (maintenance cycles) for registered devices.

- When the maintenance cycles are configured for each maintenance item, green bar graphs that are linked to the device's usage time indicate the elapsed time for each maintenance item. When the end of a maintenance cycle is reached, the corresponding bar turns orange, and notifications for the approximate replacement and cleaning periods are indicated in the tree view area.

- Click [Detailed/Overview] to display the detail screen and select the device whose maintenance cycle is to be configured from the tree pane.



- Select the [Hour Meter] tab and click [Maintenance Cycle Editor] (①).

- The maintenance cycle configuration screen will differ between Rich information model and Basic information model devices.

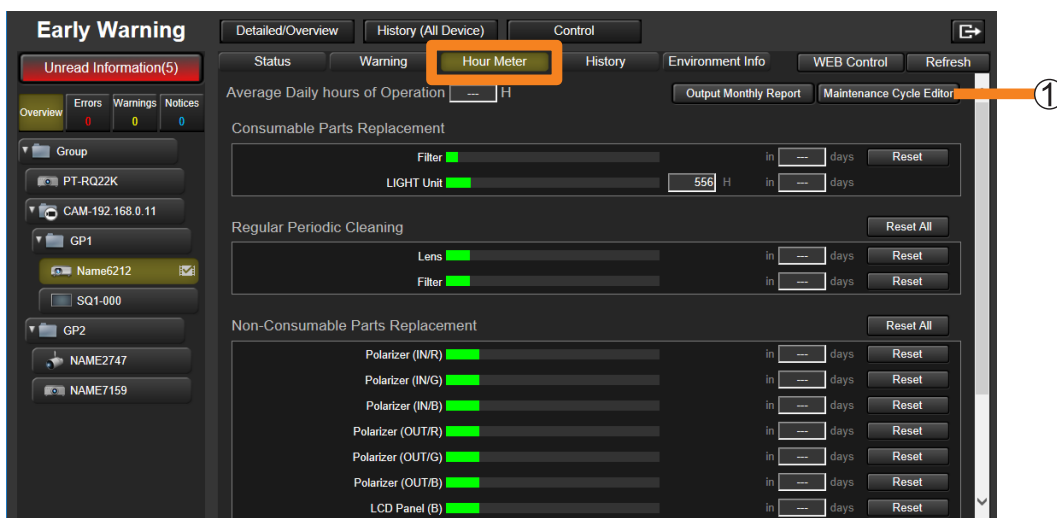



## Checking the Maintenance Timing

## ■ For “Rich information model” devices

When a device is registered as a “Rich information model”, the maintenance items and maintenance cycles for that device are displayed.

- Change the maintenance cycle settings as necessary.
- The setting ranges for the displayed maintenance items and maintenance cycles will vary depending on the device.

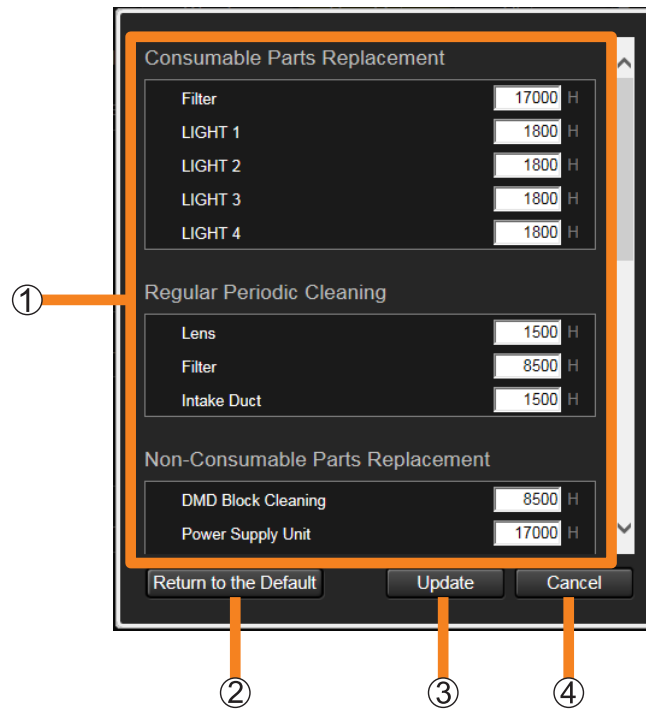

① <b>Maintenance cycle settings</b>	Sets the maintenance cycle for each item. • To change a maintenance cycle setting, enter an hour value from 1 to 99999.
② <b>[Return to the Default]</b>	Restores maintenance cycle settings to the software's pre-configured values.
③ <b>[Update]</b>	Updates the maintenance cycle settings with the settings configured here.
④ <b>[Cancel]</b>	Cancels the update, and restores the settings to the original values.

## Checking the Maintenance Timing

## ■ For “Basic information model” devices

When a device is registered as a “Basic information model”, you must select the maintenance cycle items for which you want to configure settings before configuring them.

The following maintenance cycle items typically appear for you to select and configure as necessary.

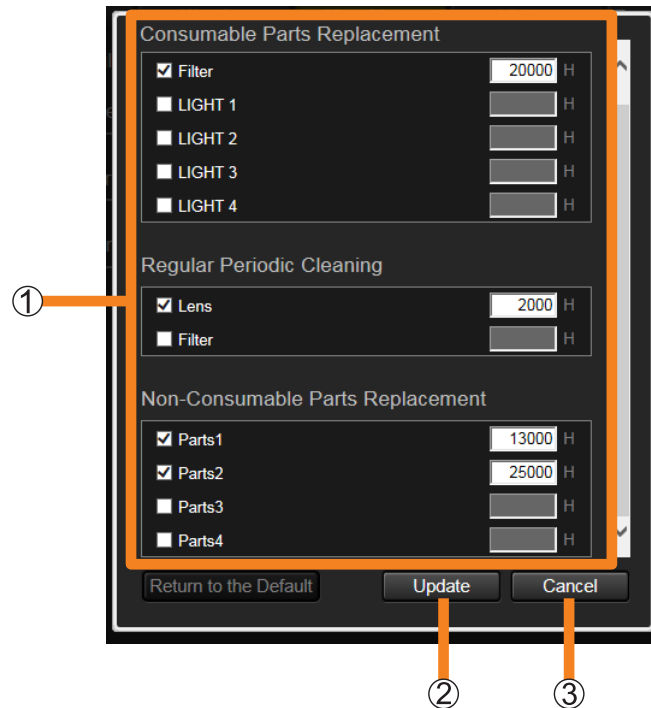

① <b>Maintenance items and cycle settings</b>	Place a check next to the items you want to configure and set their maintenance cycles. <ul style="list-style-type: none"> <li>To change a maintenance cycle setting, enter an hour value from 1 to 99999.</li> </ul>
② <b>[Update]</b>	Updates the maintenance cycle settings with the settings configured here.
③ <b>[Cancel]</b>	Cancels the update, and restores the settings to the original values.

**Notes**

- As the light device runtime is used to determine the device usage time for Basic information model devices, the maintenance cycle confirmation and notification functions cannot be used for devices for which light usage information cannot be obtained, even when the related settings are configured.
- For projectors that allow setting of the lamp power or lamp output to “ECO” or “low”, the light device runtime is calculated as if the lamp was used with the lamp power or lamp output set to “normal” or “high”. For light maintenance cycles, configure times that are calculated as if the light was used with the lamp power or lamp output set to “normal” or “high”.
- The maintenance cycle confirmation and notification functions should be configured to serve in determining when parts replacement and cleaning will be necessary. They are intended to be used as a guide.
- Projectors equipped with five or more light sources are not supported.
- When a Basic information model becomes recognized as a Rich information model by updating the Device Profile Library, the maintenance settings and maintenance cycles that you previously configured for the Basic information model will be cleared and replaced with that device’s default settings.

## Confirming Device Temperature and Voltage Information

Information from the device's internal temperature sensors and projector voltage information is collected, and the trends for each can be displayed as graphs.

- 1 Click [Detailed/Overview] to display the detail screen and select the device whose temperature or voltage information is to be checked from the tree pane.

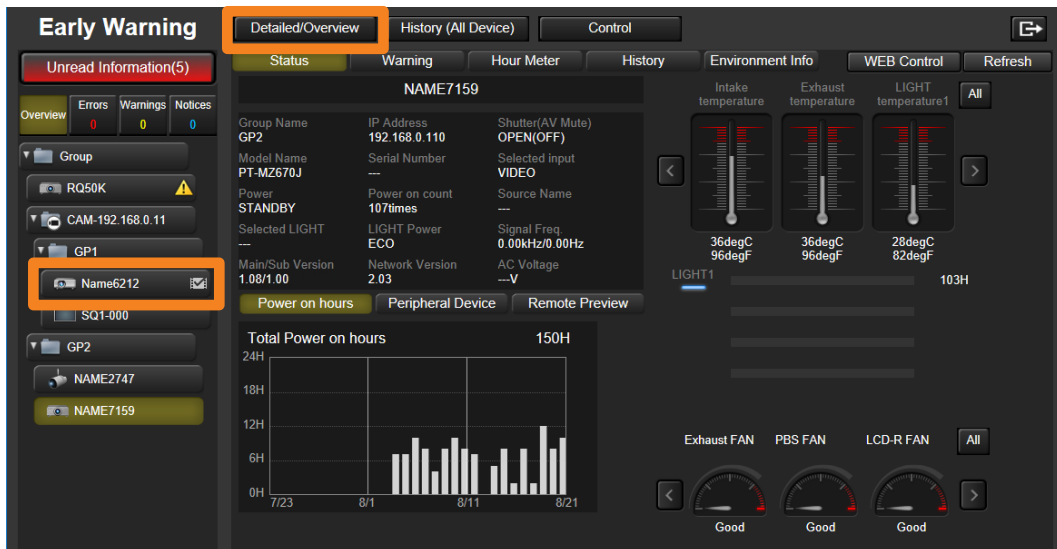

- 2 Click the [Environment Info] tab.

- The following information is displayed as a graph on the [History] screen and the [Live] screen.

**[Temperature]:** Device temperature information (page 220, 222)

**[Voltage]:** Projector voltage information (page 224, 226)



## Confirming Device Temperature and Voltage Information

### Confirming Temperature Information Histories

The temperature information collected for the past 30 days are graphically displayed so that you can check for problems with the installation environment, etc. of the device.

- 1 Click the [Environment Info] tab. (page 219)
- 2 Click [Temperature] to display the [History] screen.

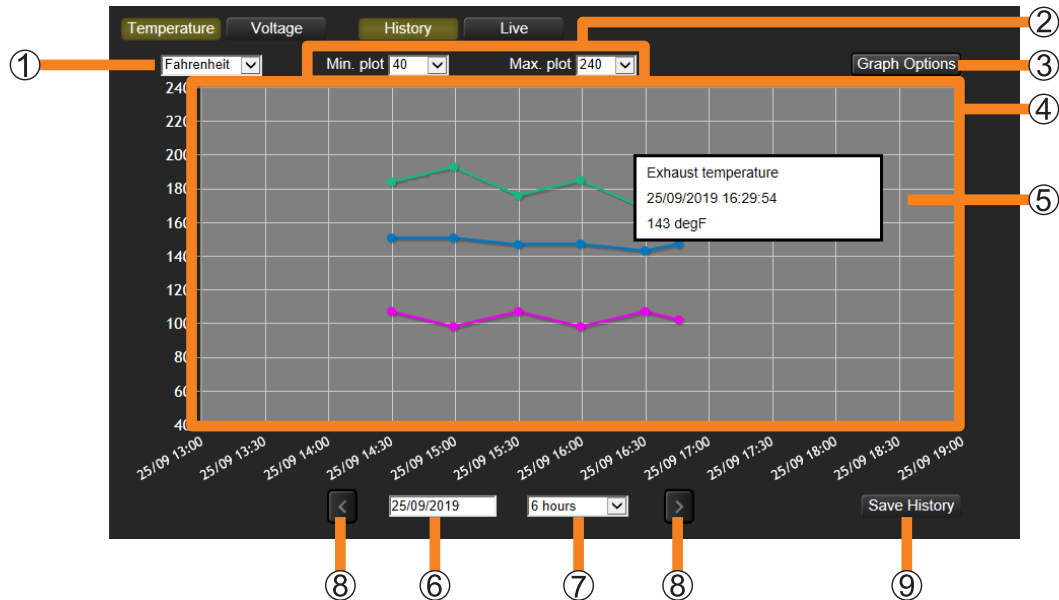

- ① **Temperature unit:** Allows you to switch the temperature unit of the graph display between Fahrenheit and Celsius.
- ② **Temperature range:** Allows you to specify the upper and lower limits of the vertical axis of the graph display within the following ranges.  
**[Min. plot]:** Celsius: -20 °C to 190 °C,  
 Fahrenheit: 0 °F to 420 °F  
**[Max. plot]:** Celsius: -10 °C to 200 °C,  
 Fahrenheit: 20 °F to 440 °F
- ③ **[Graph Options]:** Clicking the button displays the corresponding temperature information.

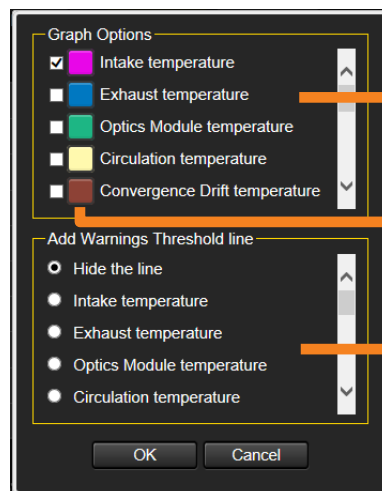



Checked graph options will be displayed in the graph. (maximum of 10)

Click to change the color displayed.

The selected warning temperature is shown in orange.

## Confirming Device Temperature and Voltage Information

- ④ **Graph view area:** Displays a temperature information graph for each of the selected items.
- ⑤ **Plot information tooltip:** Place the mouse pointer on a plot in the graph to display detailed temperature information. (You can also display it by tapping the plot.)
  - The device temperature status is indicated by the display color of the text.  
**Black:** Normal  
**Yellow:** Warning  
**Red:** Error
- ⑥ **Date selection:** Displays a calendar you can use to select the start date of the graph.
- ⑦ **Display period:** Select the period of time covered by the horizontal axis of the graph display.  
 [6 hours], [12 hours], [1 day], [5 days], [10 days]\*, or [30 days]\*.  
 \* Cannot be selected when using a tablet or iPhone.
- ⑧  /  : Click these buttons to scroll the graph within the time period selected in (⑦).
- ⑨ **[Save History]:** Displayed graphs will be saved as a compressed CSV file.

### ■ Example showing saved data

	A	B	C	D	E	F	G
1	IP Address	***.***.***.***					
2	Model Name	PT-*****					
3	Device Name	Name1234					
4	Serial Number	SW*****					
5	Group Name	Group1					
6	Set Runtime (H)	120					
7	Avg. Daily hours of Operation	0					
8							
9	Date	Intake temperature(DegC)	Intake temperature-Warning(DegC)	Exhaust temperature(DegC)	Exhaust temperature-Warning(DegC)	LIGHT temperature1(DegC)	LIGHT temperature1-Warning(DegC)
10	dd/MM/yyyy HH:mm:ss	25	38	60	85	25	30
11	dd/MM/yyyy HH:mm:ss	25	38	60	85	25	30
12	dd/MM/yyyy HH:mm:ss	25	38	60	85	25	30
13	dd/MM/yyyy HH:mm:ss	25	38	60	85	25	30
14	dd/MM/yyyy HH:mm:ss	25	38	60	85	25	30
15	dd/MM/yyyy HH:mm:ss	25	38	60	85	25	30

### Notes

- [Save History] can only be used when viewed with Microsoft Edge on a Windows OS. The [Save History] button cannot be clicked when viewed with an OS other than Windows OS such as an iOS or Android.

Confirming Device Temperature and Voltage Information

## Monitoring Temperature Changes on Devices

The latest temperature information is displayed in a graph. By monitoring temperature information for a device during operation or events, you can react promptly to signs of problems.

**1** Click the [Environment Info] tab. (page 219)

**2** Click [Temperature], then select [Live].

- The following message appears when displaying the [Live] screen for the first time after logging into the software. Click [OK] after viewing the content of the message.

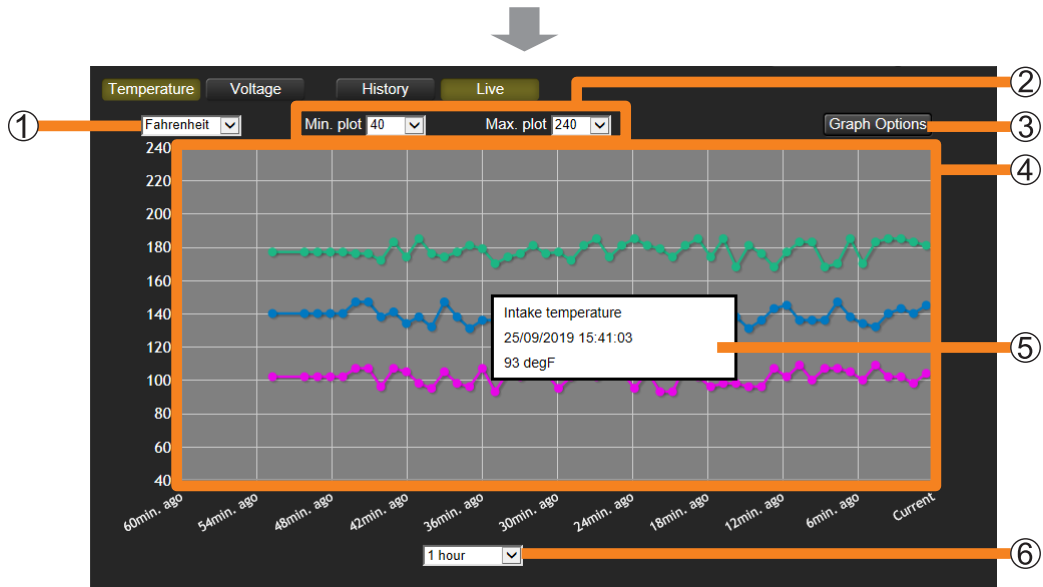
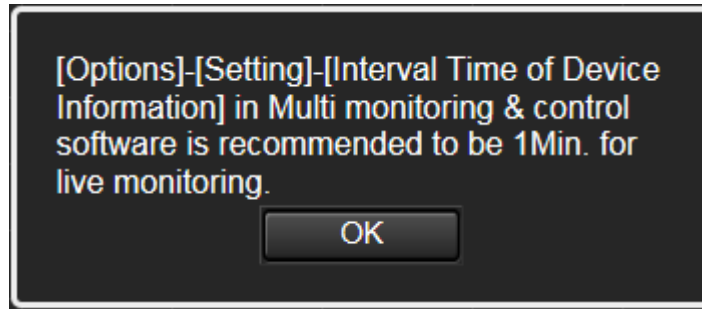

- ① **Temperature unit:** Allows you to switch the temperature unit of the graph display between Fahrenheit and Celsius.
- ② **Temperature range:** Allows you to specify the upper and lower limits of the vertical axis of the graph display within the following ranges.
  - [Min. plot]:** Celsius: -20 °C to 190 °C,  
Fahrenheit: 0 °F to 420 °F
  - [Max. plot]:** Celsius: -10 °C to 200 °C,  
Fahrenheit: 20 °F to 440 °F

## Confirming Device Temperature and Voltage Information

- ③ **[Graph Options]:** Clicking the button displays the corresponding temperature information.

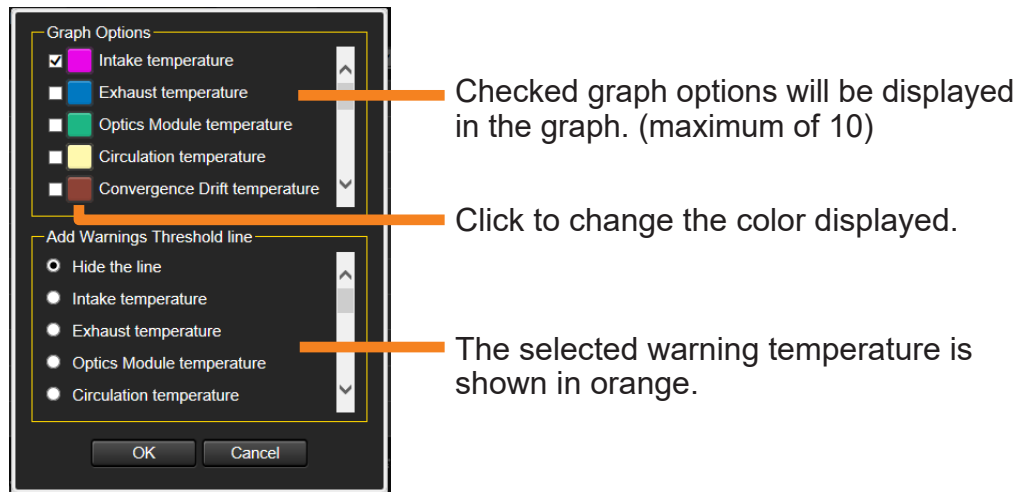

- ④ **Graph view area:** Displays a temperature information graph for each of the selected items.
- ⑤ **Plot information tooltip:** Place the mouse pointer on a plot in the graph to display detailed temperature information. (You can also display it by tapping the plot.)
- The device temperature status is indicated by the display color of the text.
    - Black:** Normal
    - Yellow:** Warning
    - Red:** Error
- ⑥ **Display period:** Select the period of time covered by the horizontal axis of the graph display.  
[10 minutes], [30 minutes], [1 hour]

### Notes

- The temperature information items that appear vary depending on the device.
- The temperature information plots may not be displayed for some devices when they are turned off.
- Temperature information is not displayed for devices without built-in temperature sensors or devices belonging to the “Basic information model” group.
- The interval at which the monitoring screen is updated depends on the [Interval Time of Device Information] setting.

The shorter the value specified for the [Interval Time of Device Information] setting, the faster the monitoring screen is updated, allowing for more detailed tracking of temperature changes. To check detailed changes in the graph, setting [Interval Time of Device Information] to 1 minute is recommended. However, this will result in heavier network loads, so adjust the [Interval Time of Device Information] setting as necessary.

For details about the [Interval Time of Device Information] setting, see page 229.



## Confirming Device Temperature and Voltage Information

## Checking the History of Collected Voltage Data

The voltage information collected for the past 30 days is graphically displayed so that you can check for problems with the installation environment, etc., of the device.

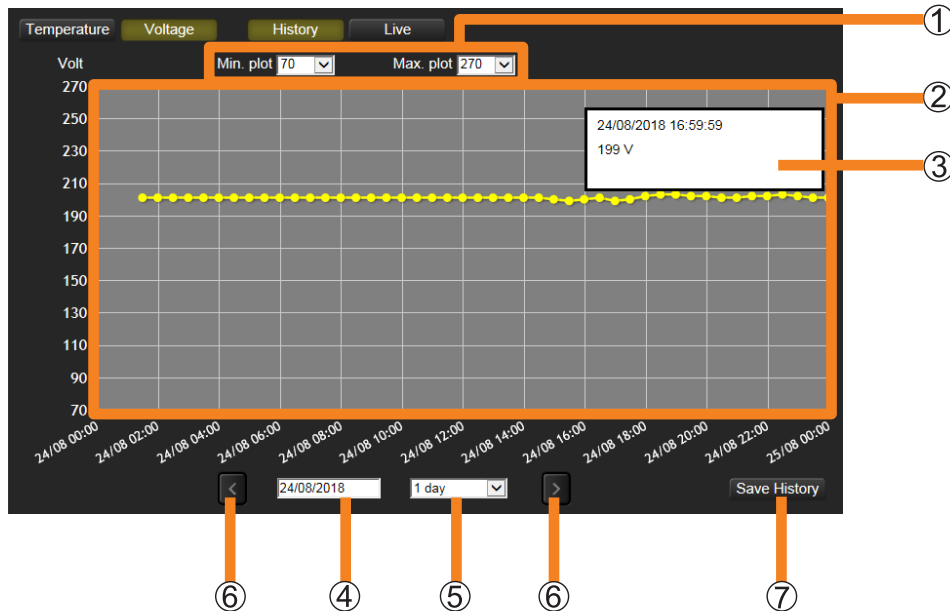
- 1 Click the [Environment Info] tab. (page 219)
- 2 Click [Voltage] to display the [History] screen.



- ① **Voltage Range:** Allows you to specify the upper and lower limits of the vertical axis of the graph display within the following ranges.
  - [Min. plot]: 0 V to 260 V
  - [Max. plot]: 10 V to 270 V
  - Measurement gradations are assigned automatically (integer values) so that there are 10 gradations between the specified upper and lower limits.
- ② **Graph view area:** Voltage information will be displayed in the graph. (Yellow)
  - For periods where no information could be obtained, there are gaps in the graph where nothing is displayed.
- ③ **Plot information tooltip:** Place the mouse pointer on a plot in the graph to display detailed voltage information. (You can also display it by tapping the plot.)
  - The input voltage status is indicated by the display color of the text.
    - Black:** The input power supply voltage is appropriate.
    - Yellow:** The input power supply voltage is too low.
- ④ **Date selection:** Displays a calendar you can use to select the start date of the graph.
- ⑤ **Display period:** Select the period of time covered by the horizontal axis of the graph display.
  - [6 hours], [12 hours], [1 day], [5 days], [10 days]\*, or [30 days]\*.
  - \* Cannot be selected when using a tablet or iPhone.
- ⑥  / : Click these buttons to scroll the graph within the time period selected in (⑤).
- ⑦ **[Save History]:** Displayed graphs will be saved as a compressed CSV file.



## Confirming Device Temperature and Voltage Information

## ■ Example showing saved data

	A	B	C
1	IP Address	***.***.***.***	
2	Model Name	PT-*****	
3	Device Name	Name1234	
4	Serial Number	SW*****	
5	Group Name	Group1	
6			
7	Date	AC Voltage(V)	Notification
8	dd/MM/yyyy HH:mm:ss	100	
9	dd/MM/yyyy HH:mm:ss	102	
10	dd/MM/yyyy HH:mm:ss	80	Warning
11	dd/MM/yyyy HH:mm:ss	102	
12	dd/MM/yyyy HH:mm:ss	100	
13	dd/MM/yyyy HH:mm:ss	101	
14	.		
15	.		
16	.		

**Notes**

- [Save History] can only be used when viewed with Microsoft Edge on a Windows OS. The [Save History] button cannot be clicked when viewed with an OS other than Windows OS such as an iOS or Android.
- In the following cases voltage information cannot be output even if a graph is displayed:
  - If the connected device does not match the registered details
  - If the projector has been removed

## Confirming Device Temperature and Voltage Information

## Monitoring Projector Voltage Trends

The latest voltage trend is displayed in a graph. By monitoring the voltage status of a device during operation or events, you can react promptly to signs of problems.

**1 Click the [Environment Info] tab. (page 219)**

**2 Click [Voltage], then select [Live].**

- The following message appears when displaying the [Live] screen for the first time after logging into the software. Click [OK] after viewing the content of the message.

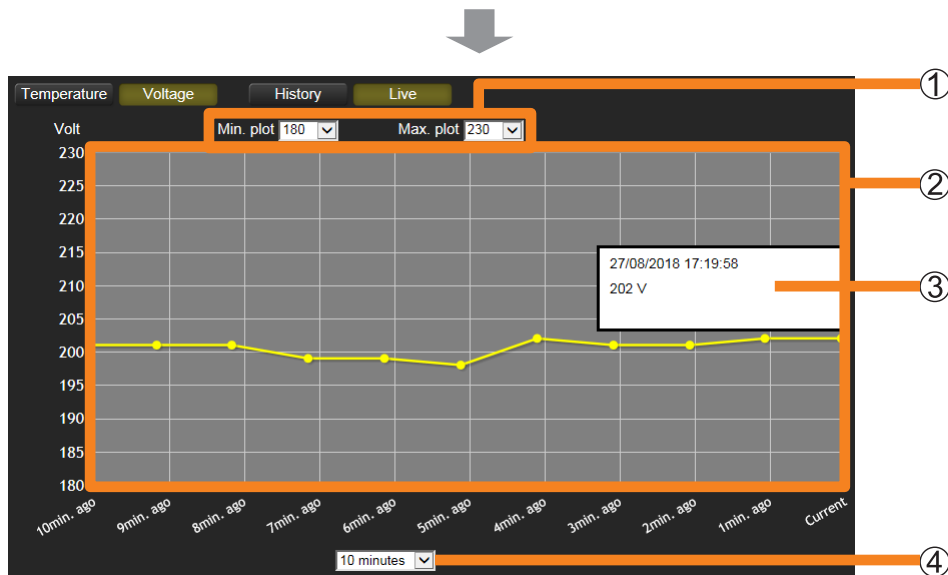
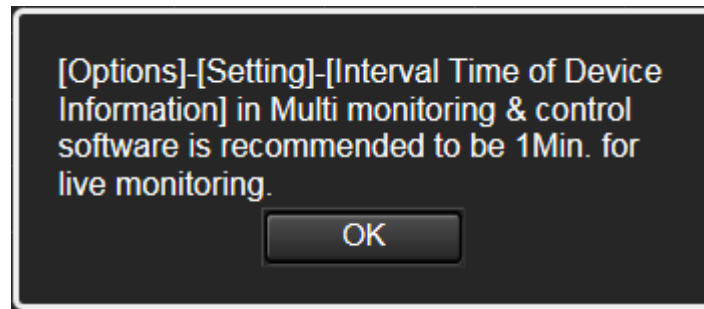

- ① **Voltage Range:** Allows you to specify the upper and lower limits of the vertical axis of the graph display within the following ranges.  
**[Min. plot]:** 0 V to 260 V (Default setting value: 70 V)  
**[Max. plot]:** 10 V to 270 V (Default setting value: 270 V)
- ② **Graph view area:** Voltage information will be displayed in the graph. (Yellow)

### Confirming Device Temperature and Voltage Information

---

- ③ **Plot information tooltip:** Place the mouse pointer on a plot in the graph to display detailed voltage information. (You can also display it by tapping the plot.)
  - The input voltage status is indicated by the display color of the text.
    - Black:** The input power supply voltage is appropriate.
    - Yellow:** The input power supply voltage is too low.
- ④ **Display period:** Select the period of time covered by the horizontal axis of the graph display.  
[10 minutes] (Default setting value), [30 minutes], [1 hour]

#### Notes

- Voltage information is not displayed for devices without built-in voltage sensors or devices belonging to the “Basic information model” group.
- The interval at which the monitoring screen is updated depends on the [Interval Time of Device Information] setting.

The shorter the value specified for the [Interval Time of Device Information] setting, the faster the monitoring screen is updated, allowing for more detailed tracking of voltage changes. To check detailed changes in the graph, setting [Interval Time of Device Information] to 1 minute is recommended. However, this will result in heavier network loads, so adjust the [Interval Time of Device Information] setting as necessary.

For details about the [Interval Time of Device Information] setting, see page 229.

# Setting the Monitoring and Control functions

## Setting the Monitoring and Control's option function

**1** Select [Options] → [Setting] from the menu.

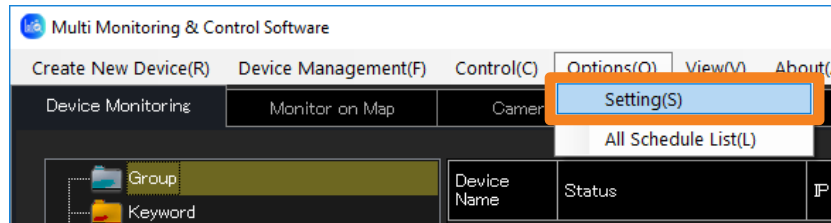

**2** When the <Setting> window is displayed, select the tab you want to change the setting of and set the details.

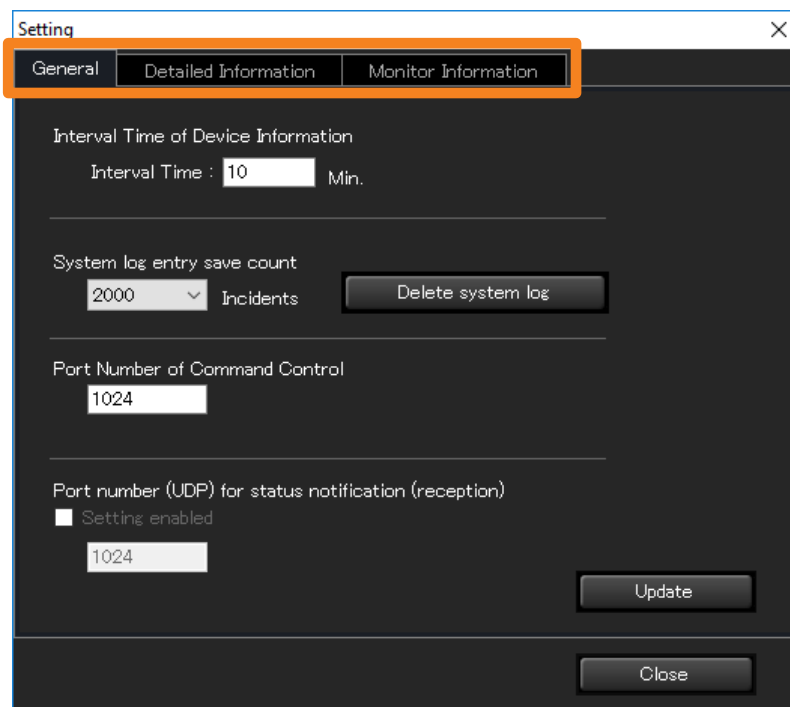

For how to configure each setting, see the following pages.

- **[General]**
  - [Interval Time of Device Information] (page 229)
  - [System log entry save count] and system history deletion (page 230, 231)
  - [Port Number of Command Control] (page 232)
  - [Port number (UDP) for status notification (reception)] (page 233)
- **[Detailed Information]** (page 234)
- **[Monitor Information]** (page 234)

**3** After configuring the settings, click [Close] to close the <Setting> window.

## Setting the Information Updating Interval

Information regarding devices being monitored/controlled can be updated at regular intervals.

**1 Click the [General] tab. (page 228)**

**2 Set the [Interval Time].**

The time interval can be selected from 1 to 90 minutes in 1-minute increments.

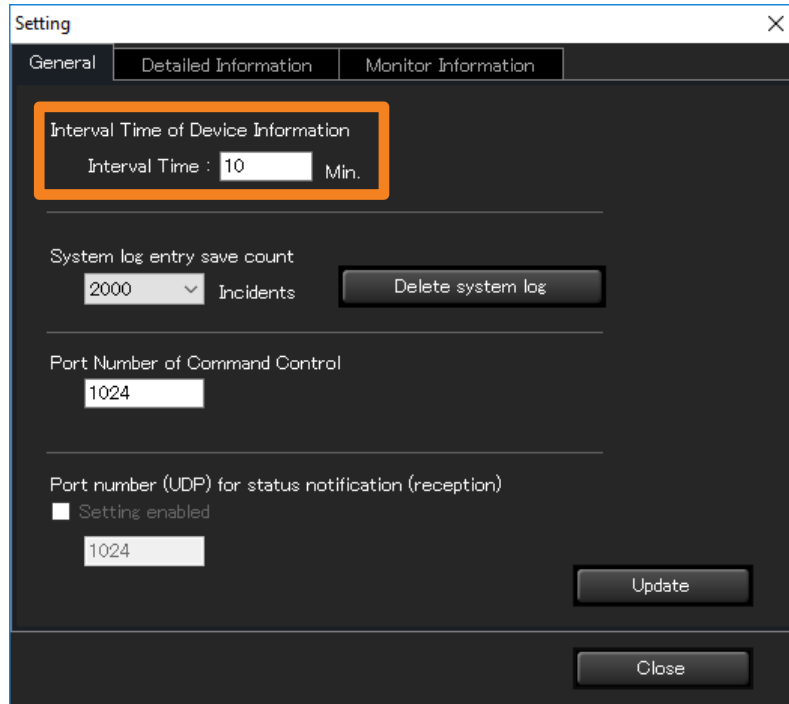

**3 Click [Update].**

An update message appears. Click [OK].

- If [Update] is clicked after characters other than 1 to 90 or no characters at all are entered in [Interval Time], the following message will appear.

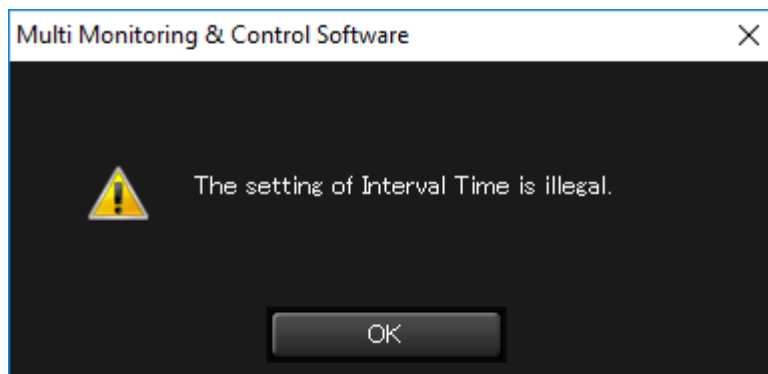

### Notes

- It may not be impossible to acquire information for all devices when there are many registered devices and [Interval Time of Device Information] is short. In this case, extend [Interval Time of Device Information].

## Setting the Number of System History Entries that can be Saved

Use the following steps to set the number of system history entries (page 196) that can be saved.

**1** Click the [General] tab. (page 228)

**2** Set [System log entry save count].

From the pull-down menu, select [500], [1000] or [2000].

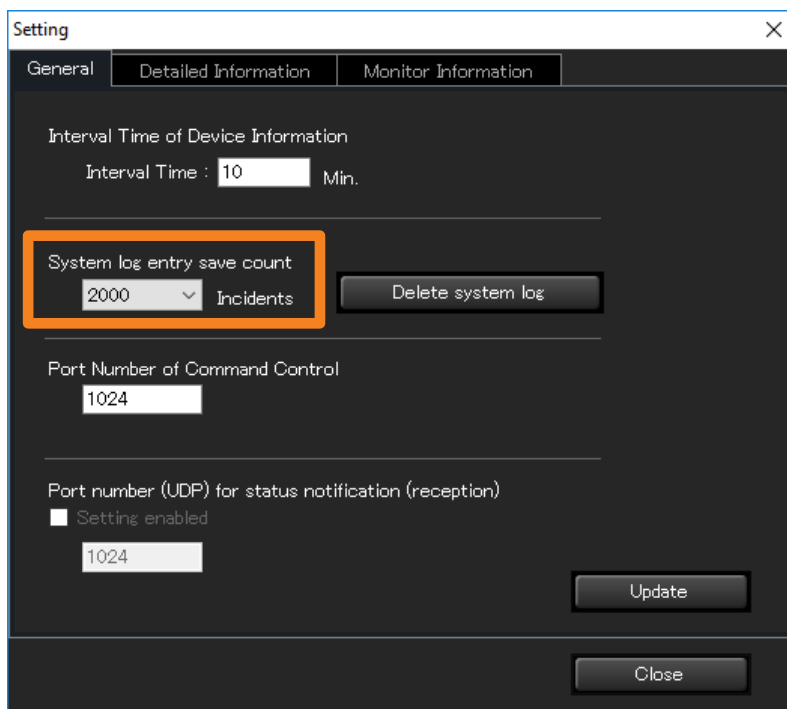

**3** Click [Update].

An update message appears. Click [OK].

## Setting the Number of System History Entries that can be Saved

### Deleting the System History Information

Use the steps below to delete saved system history data.

**1** Click the [General] tab. (page 228)

**2** Click [Delete system log] (①).

Click [Yes] in the delete confirmation message that appears. The system history data is deleted. However, the device history data (page 196) is not deleted.

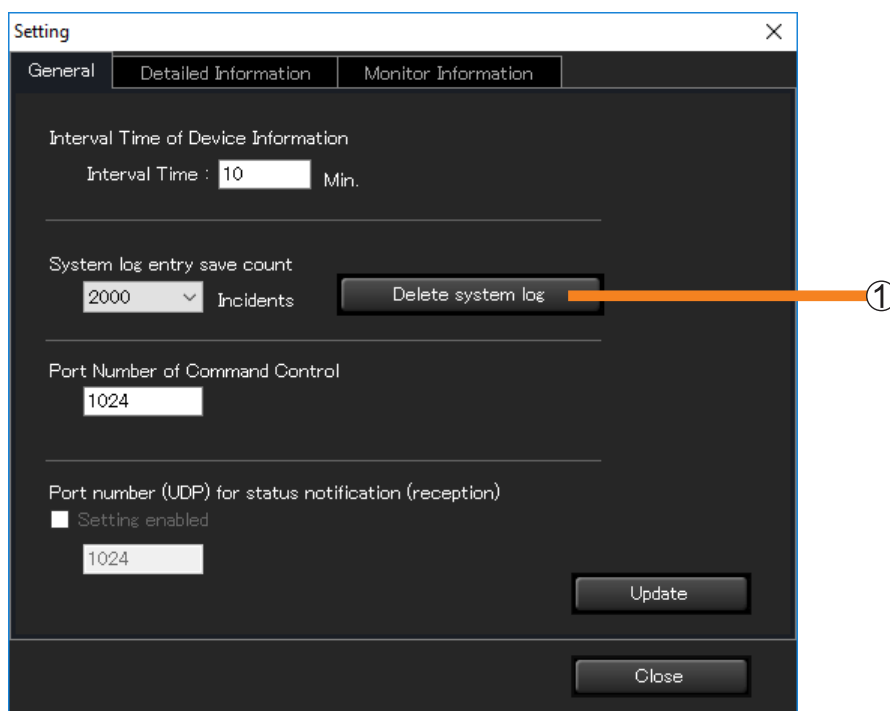

#### Notes

- Deleting the system history information will delete the brief system history information as well.

## Setting the Port Number for Command Control

Set the port number for the command control to be used in communication with the device.

### 1 Click the [General] tab. (page 228)

### 2 Enter the port number for command control in ①.

- If there is a port number setting for command control in the setting items of the device to be used, match this setting to that setting. (Default setting value : 1024)

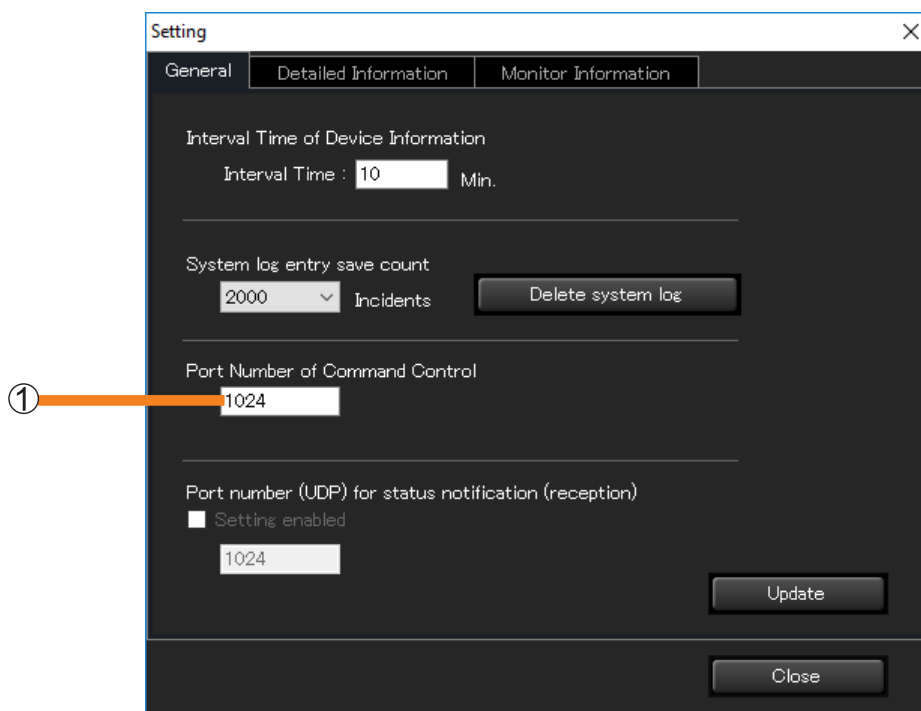

### 3 Click [Update].

When the settings are complete, a message to inform updating is complete will be displayed. Click [OK].

#### Notes

- For connecting to multiple devices, you need to make sure the port numbers match on all the devices.
- If the port number is incorrect, the information cannot be retrieved.



## Setting the Status Notification Function

Set a port number for receiving status notifications from devices.

By setting the status notification function, you can track via the software the status of flat panel displays when the power lamp flashes red due to a malfunction, even if the displays are in a remote location that prevents checking the power lamp directly.

**1** Click the [General] tab. (page 228)

**2** Place a check mark in [Setting enabled] (①).

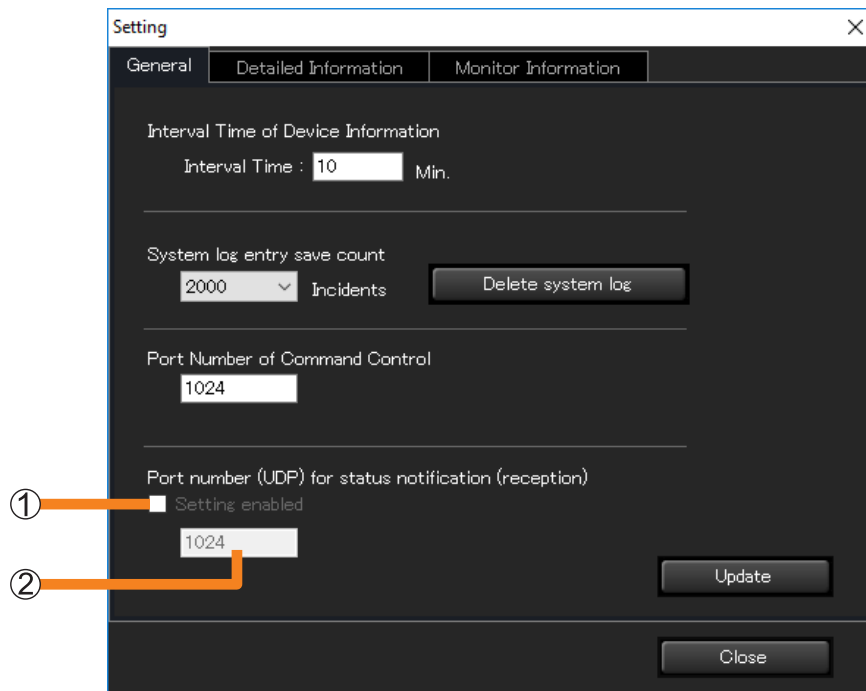

**3** Enter the port number for status notifications (reception) in (②).

- Default setting value : 1024

**4** Click [Update].

When the settings are complete, a message to inform updating is complete will be displayed. Click [OK].

### Notes

- To use the status notification function, it is necessary to make settings in the <Web Control> window of the device (status notification settings page). For details about setting the <Web Control> window, please refer to the operating manual for the device being used.
- It is not possible to receive status notifications from a device if the port number entered does not match the port number of the device.
- For connecting to multiple devices, you need to make sure the port numbers match on all the devices.
- In the tree view area (page 182) you can check errors based on status notifications received from devices. If an error or warning from the early warning function is displayed in the window, report the error number to your retailer.
- For flat panel displays that support the status notification function. To see if the flat panel display being used is supported, refer to the "List of Compatible Device Models" of this application software which is posted on the following website.  
<https://panasonic.net/cns/prodisplays/download/software/>

## Changing the Information Displayed on the Information Display Windows

Items displayed on the Detailed Information Display (page 90) and Brief Information Display (page 81), as well as the display sequence can be changed.

**1** Click the **[Detailed Information]** or **[Monitor Information]** tab.

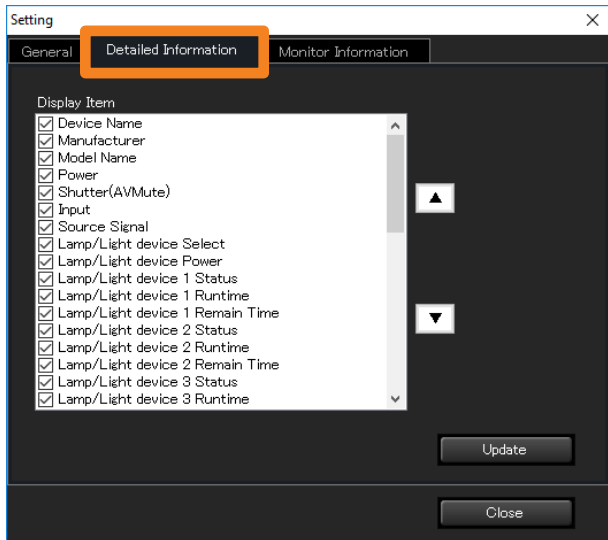

**[Detailed Information] window**

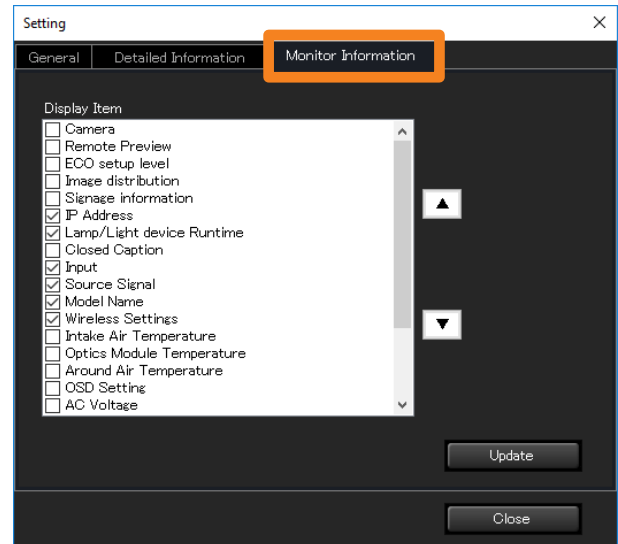

**[Monitor Information] window**

Items checked under [Display Item] will be displayed on each window. When you select an item and click [▲] / [▼], the item moves up or down and the display sequence changes.

**2** Click **[Update]**.

An update message appears. Click [OK].

# Setting up the Early Warning Function

## Setting the Early Warning Function of Monitoring and Control

1 Open the [Early Warning Configurations] tab and click [Others].

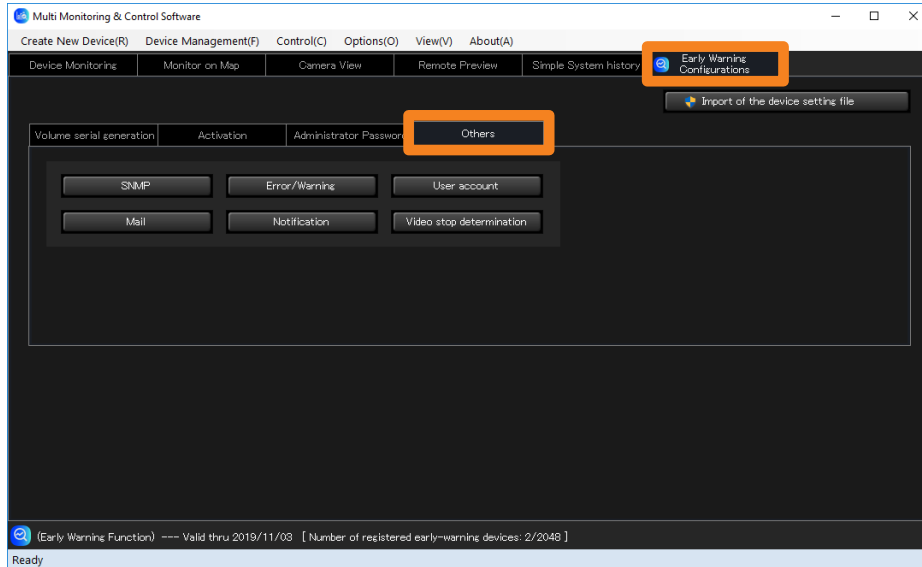

For how to configure each setting, see the following pages.

- [SNMP] (page 236)
- [Mail] (page 239)
- [Error/Warning] (page 243)
- [Notification] (page 245)
- [User account] (page 247)
- [Video stop determination] (page 251)

## Setting SNMP Notifications

When an SNMP manager is installed on the same network as the monitoring and control terminal, this software can use SNMP traps to report the error, warnings and notifications that a device causes.

Types of SNMP traps that are sent

Type	OID	
	Enterprise	Specific-Trap
Error occurred	1.3.6.1.4.1.258.1000.1.1	101
Error cleared	1.3.6.1.4.1.258.1000.1.1	102
Warning occurred	1.3.6.1.4.1.258.1000.1.2	101
Warning cleared	1.3.6.1.4.1.258.1000.1.2	102
A notification was sent*	1.3.6.1.4.1.258.1000.1.3	101
A notification was cleared*	1.3.6.1.4.1.258.1000.1.3	102

\* You can also configure notifications from [Notification]. (page 245)

### 1 Open the [Others] tab (page 235), and click [SNMP].

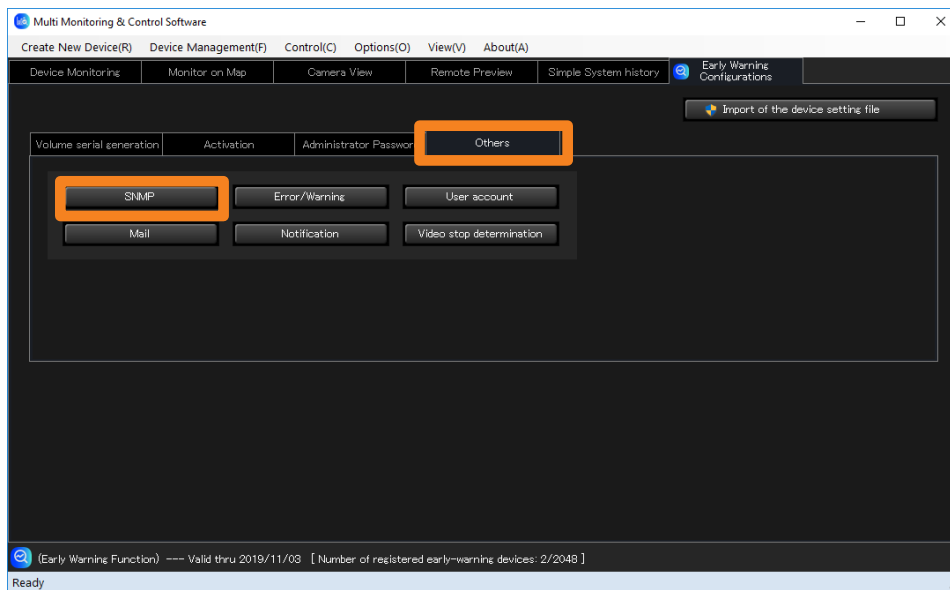

## Setting SNMP Notifications

**2** Select the [Notify by SNMP Trap] check box and configure the settings required for SNMP notifications.

[SNMP Manager IP Address]: Enter the IP address.

[SNMP Manager Host Name]: Enter the host name.

[SNMP Community Name]: Enter the community name to enable authentication between the SNMP manager and this software.

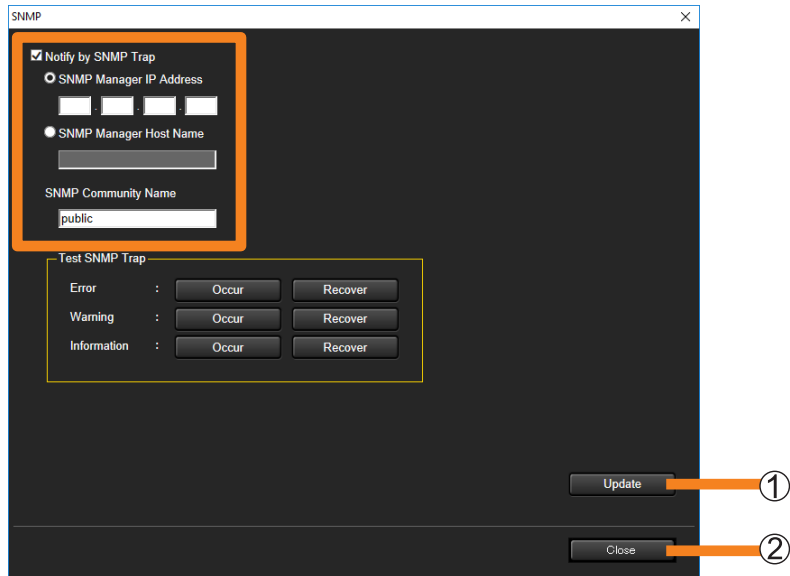

**3** Click [Update] (①).

A message indicating that the update was successful appears. Click [OK] to update the settings.

- Click [Close] (②) if you decide not to update.

**4** Click [Occur] and [Recover] under [Test SNMP Trap].

This sends an SNMP trap whenever an error, warning, or notification is issued or canceled.



### Setting SNMP Notifications

---

#### Notes

- This requires that an SNMP manager runs in the system configuration you use.
- The software can only send SNMP trap transmissions initiated by the SNMPv1 [RFC1155, RFC1157] trap command.
- The MIB (management information base) used for sending SNMP traps can be acquired as follows.
  - ① Log in to PASS from one of the following websites.  
<https://panasonic.net/cns/projector/pass/>  
<https://panasonic.net/cns/prodisplays/pass/>
  - ② Click [Download] from the side menu.
  - ③ Click Select Utility Software → Early Warning Software → [MIB].
  - ④ Click [Download] to begin downloading.
- For details on how to set up an SNMP manager, consult your network administrator.

## Configuring the Required Settings for Sending Mail

Use the steps below to send data on errors, warnings and notifications caused by a device via mail to an E-mail address specified by this software.

- 1 Open the [Others] tab (page 235), and click [Mail].

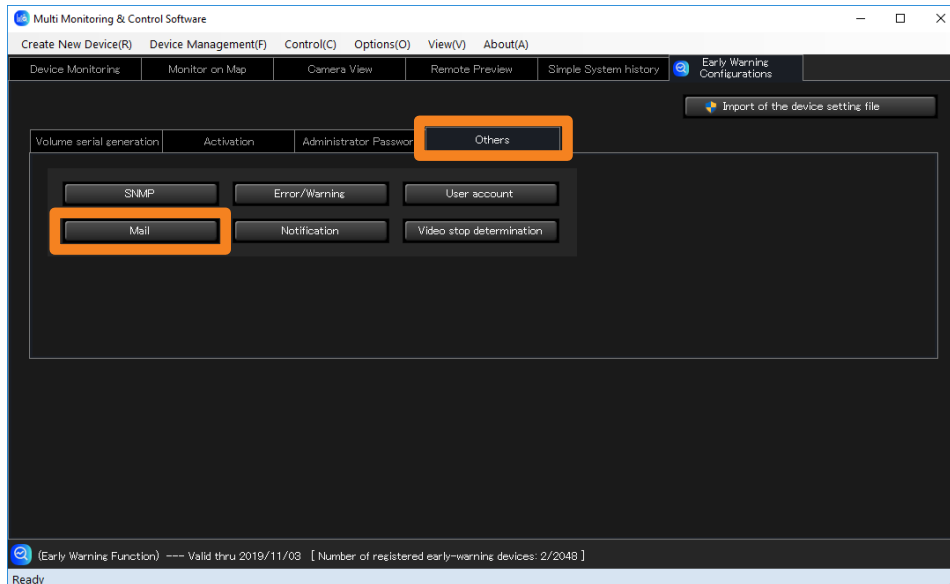

- 2 Select the [Notify by E-Mail] check box and enter the [SMTP Server Name] and the [SMTP Server Port Number].

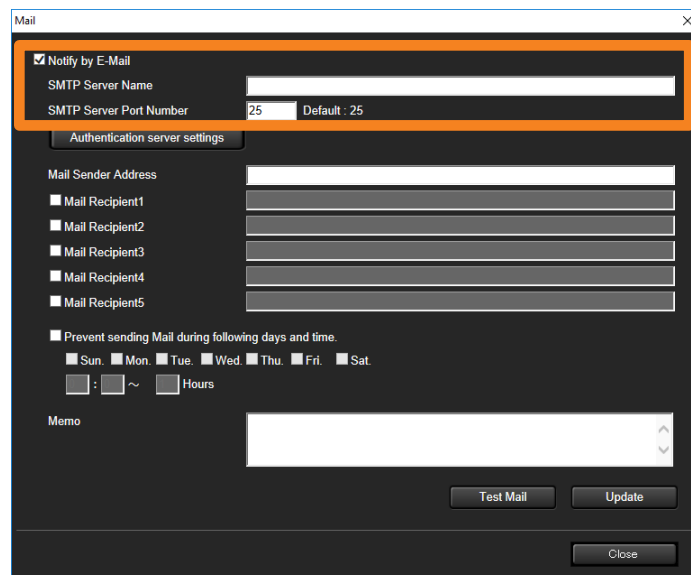

## Configuring the Required Settings for Sending Mail

### 3 To make an authentication server setting, click [Authentication server settings].

The Authentication Server Setting area appears. Select the authentication method for sending mail.

- Go to step 4 if you do not need to set an authentication server.

- ① **[SMTP Authentication]:** Select an authentication method from [PLAIN], [LOGIN], or [CRAM-MD5].
- ② **[POP Before SMTP]:** Enter the [POP Server Name], [POP Server Port Number], [User Name] and [Password].

### 4 Enter the email addresses of the sender and recipients.

- ③ **[Mail Sender Address]:** Enter the email address of the monitoring and control terminal.
- ④ **[Mail Recipient]:** Select the check boxes and enter the email addresses of recipients in the same network. (Maximum of 5)



## Configuring the Required Settings for Sending Mail

### 5 Select the [Prevent sending Mail during following days and time.] check box to disable sending mail at certain times.

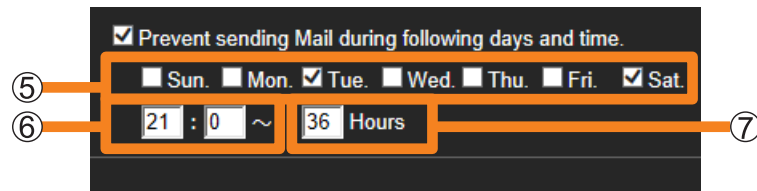

- ⑤: Check the day of the week to disable sending of mail.
- ⑥: Enter the start time, in the range “00:00” to “23:59”, at which to disable sending of mail.
- ⑦: Enter the number of hours, in the range “1” to “99”, to disable the sending of mail starting from the time set in ⑥.

Example:

To disable sending of mail from 9pm every Tuesday to 9am Thursday and from 9pm every Saturday to 9am Monday, check the [Tue.] and [Sat.] check boxes, enter “21:00” in the time boxes, and enter “36” for the number of hours.

### 6 Enter [Memo].

- Enter the text to appear in the body of the email. Fill in as necessary.

### 7 Click [Test Mail] to send a test mail.

- Send a test email to the destination email addresses you entered in step 4.

Test mail example:

Subject: Panasonic Device Report (Test)

Body: This is a test mail from Early Warning Software.

### 8 Click [Update].

A message indicating that the update was successful appears. Click [OK] to update the settings.

#### Notes

- Enter the mail address in the “\*\*\*(local-part)@\*\*\*(domain)” format.
- To use the mail transmission function, you must have a mail server in your system configuration. The mail address of the monitoring and control terminal must be registered in the mail server.
- For details on how to register and configure a mail server, consult your network administrator.

## Configuring the Required Settings for Sending Mail

### ■ Example of Mail Transmission

Mail subject: Panasonic Device Report (Error/Warning/Information)

o Shipping date: June 7, 2013, 10:55:38 **Mail send date**

---

o Device Information:

- Group Name: Group
- Device Name: DZ21K
- IP address: \*\*\*.\*\*\*.\*\*\*.\*\*\*
- Model Name: DZ21K
- Serial Number: AB1234567
- Main Version: 1.00
- Sub Version : 1.00
- Network Version: 1.03

**Device setting data**

---

o Detected data:

- Status: Warning
- Detail 1: Color prism 3, fan error
- Suggested action 1: Have your dealer inspect the fan.
  - The color prism cooling fan 3 has reached the level threshold.
- Detail 2: Projector LAN connection error
- Suggested action 2: Check whether the LAN cable is properly connected.
  - Check whether the main power supply has been turned on.

**Device error, warning, notification details and suggested action**

---

Power: On

- Set power on hours: 16984 hrs
- LIGHT 1 power on hours: 4 hrs
- LIGHT 2 power on hours: 3 hrs
- LIGHT 3 power on hours: 3 hrs
- LIGHT 4 power on hours: 3 hrs
- Remaining time for LIGHT 1: 1996 hrs
- Remaining time for LIGHT 2: 1996 hrs
- Remaining time for LIGHT 3: 1997 hrs
- Remaining time for LIGHT 4: 1997 hrs
- Power on times: 154 times
- Color prism cooling 3 fan belt: 465
- Color prism cooling 3 fan data 1: 4CE
- Color prism cooling 3 fan data 2: 0AF
- Intake temperature: 25 degC/77 degF
- Exhaust temperature: 26 degC/78 degF
- Temperature around optical module: 30 degC/86 degF

**Light power on hours, remaining time and temperature data**

---

o Memo: **Memo data**

## Setting a Warning to Report that a Device is Not Connected

Use the steps below to output a warning to notify when for some reason a device is not connected to the network. A warning is output when connection with a device cannot be confirmed after a preset number of connection attempts during a device update.

If you are aware in advance that a device will not be connected on specific days or times, you can configure settings to disable disconnection warnings during those days or times.

### 1 Open the [Others] tab (page 235), and click [Error/Warning].

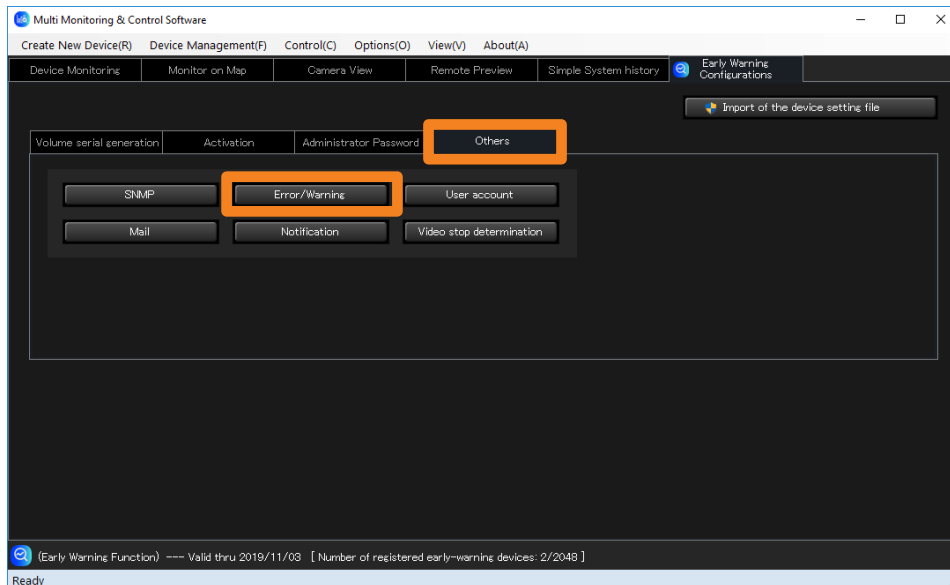

### 2 Select the [Warn if device is not found in network] check box and enter [Number of retries before Warning].

Enter a value between “1” and “99”.

- If greater the number of retries before warning, the longer it will take to determine that a device is not connected.

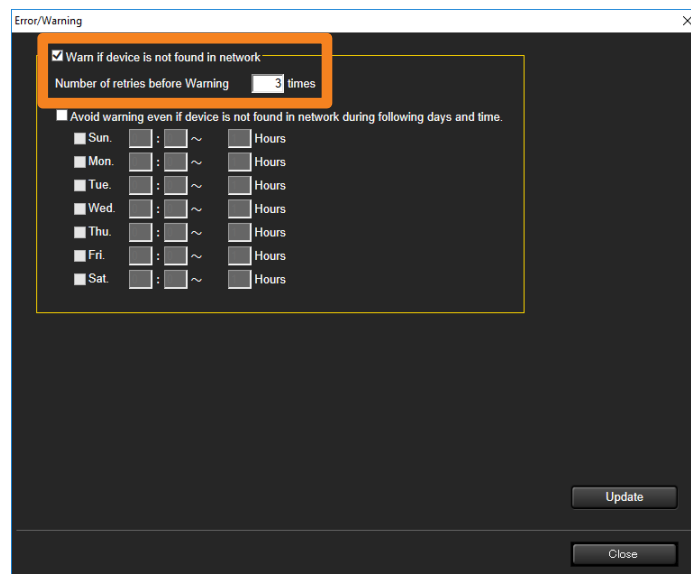

## Setting a Warning to Report that a Device is Not Connected

### 3 Select the [Avoid warning even if device is not found in network during following days and time.] check box, and configure the settings to disable disconnection warnings at certain times.

- To keep disconnection warnings enabled at all times, proceed to step 4 without selecting [Avoid warning even if device is not found in network during following days and time].

Day	Start Time	Duration
<input type="checkbox"/> Sun.	: ~	Hours
<input type="checkbox"/> Mon.	: ~	Hours
<input checked="" type="checkbox"/> Tue.	10 : 30 ~	24 Hours
<input type="checkbox"/> Wed.	: ~	Hours
<input type="checkbox"/> Thu.	: ~	Hours
<input type="checkbox"/> Fri.	: ~	Hours
<input checked="" type="checkbox"/> Sat.	8 : 30 ~	24 Hours

- ①: Select the check boxes for the days on which disconnection warnings will be disabled.
- ②: Enter the start times, in the range “00:00” to “23:59”, for the periods at which disconnection warnings will be disabled.
- ③: Enter the number of hours, in the range “1” to “48”, to disable warnings starting from the time set in ②.

Example:

Configure the settings as shown in the screen above to disable disconnection warnings every week for 24 hours from 10:30 AM Tuesday to 10:30 AM Wednesday and for 24 hours from 8:30 AM Saturday to 8:30 AM Sunday.

### 4 Click [Update].

A message indicating that the update was successful appears. Click [OK] to update the settings.

## Updating Notification Data

Use the following steps to set the number of days remaining until a consumable parts replacement, regular periodic cleaning and non-consumable parts replacement are announced and to make settings to send notifications via mail or SNMP transmission.

This also allows you to set notifications for devices that operate for a long time or that are otherwise left turned on.

### 1 Open the [Others] tab (page 235), and click [Notification].

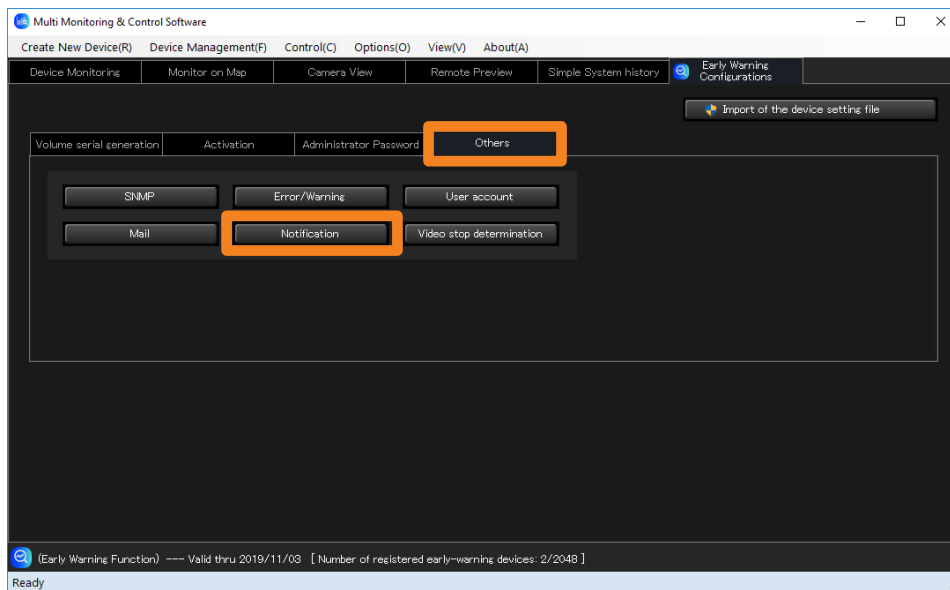

### 2 Set how many days in advance to issue each notification.

Enter the number of days in the range "0" to "999".

- A setting of 0 days mean that no notification will be made. However, if 0 days is set for [Consumable Parts Replacement] and [Non-Consumable Parts Replacement], those replacement warnings will still be sent by mail and SNMP trap transmission.

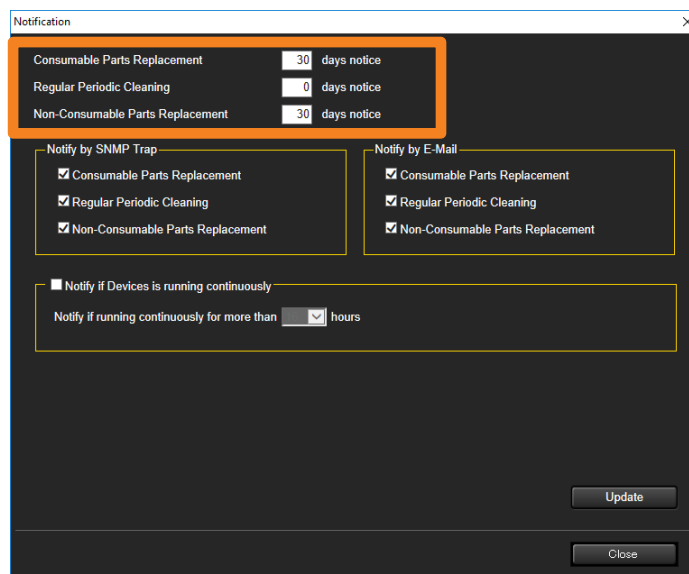

## Updating Notification Data

- 3** In [Notify by SNMP Trap] (①), select the notifications to be performed by SNMP, and in [Notify by E-Mail] (②), select the notifications to be performed by mail.

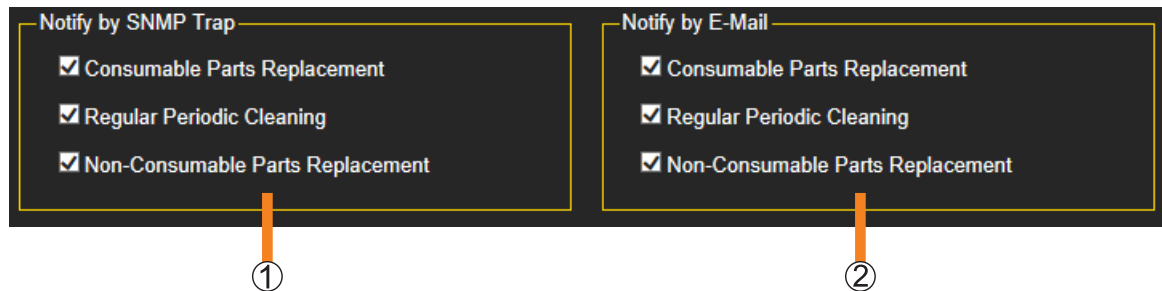

- 4** To provide notification of continuous running, select the [Notify if Devices is running continuously] check box, and select [8 hours], [16 hours], or [24 hours] as the continuous operation time that requires notification.

A notification is sent if the powered-on state exceeds the specified number of hours.

- If the power is cycled off/on while the software is updating information, the power state may be recognized as being continuously powered-on, even though the device was actually not running continuously. For example, if the interval to automatically acquire device information ([Interval Time of Device Information]) is set to 90 minutes, and the device is turned off and on between one automatic update and the next, this software cannot recognize the change in power status of the device.

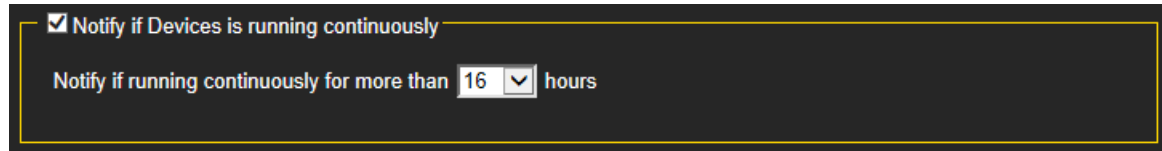

- 5** Click [Update].

A message indicating that the update was successful appears. Click [OK] to update the settings.

### Notes

- The [Notify by SNMP Trap] setting causes notification to be sent via an SNMP notification when SNMP is enabled in the SNMP configuration screen.
- The [Notify by E-Mail] setting causes notification to be sent via an E-mail message when the mail setting is enabled in the mail configuration screen.

## Registering, Deleting and Changing User Account Control

Use the steps below to perform the user management for logging in to the early warning function from a web browser.

### Registering a user

**1** Open the [Others] tab (page 235), and click [User account].

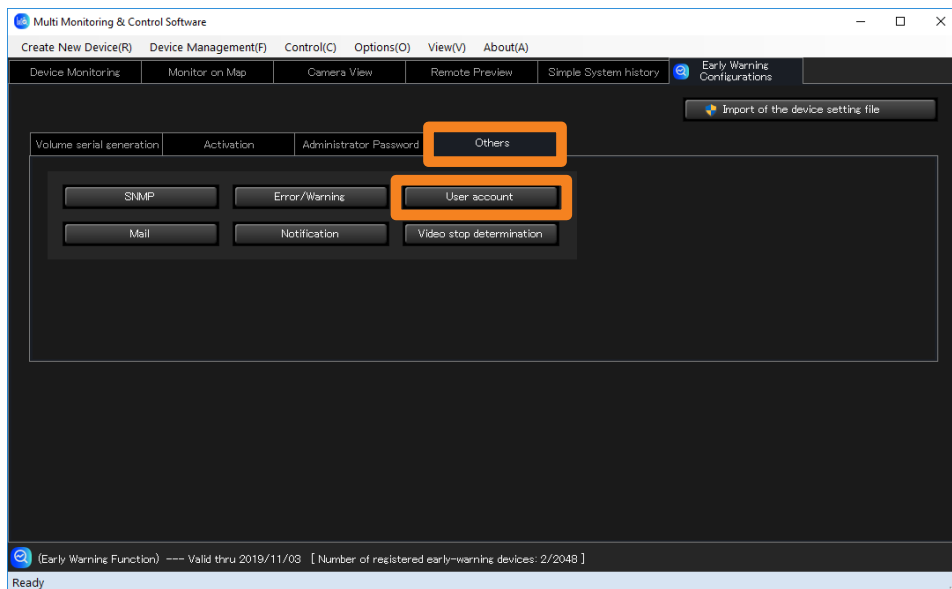

**2** Click [Add new Account].

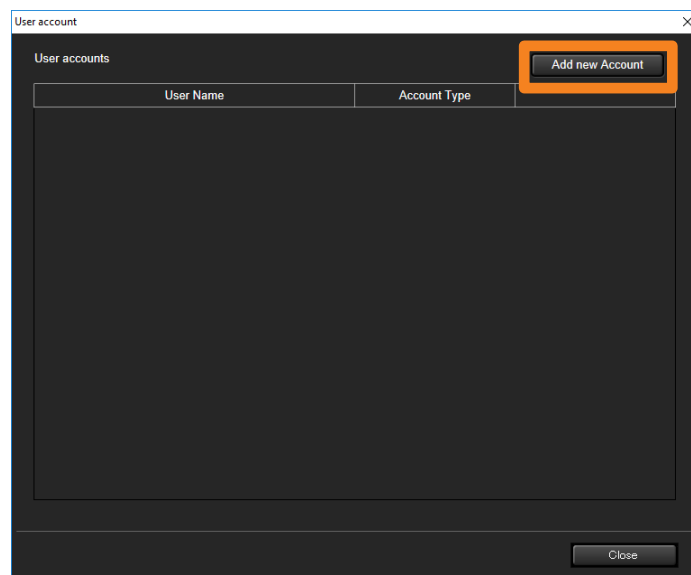

## Registering, Deleting and Changing User Account Control

### 3 Enter the user information.

**[User Name]:** Enter the login user ID. (Up to 64 single-byte alphanumeric characters)

**[Account Type]:** Select [Administrative User] for users who are to be assigned administrator privileges, or [Standard User] for users who will not be registering devices.

**[Password]:** Enter the login password.

**[Confirm Password]:** Re-enter what you typed in [Password].

- If you click [Cancel] (①), the entered content will be canceled.

### 4 Click [Register] (②).

You will return to the screen in step 2, and the registered user will appear in the [User accounts].

- If continuing to register a user, repeat steps 2 to 4. (Maximum of 100 people).
- An error message appears if an attempt is made to register an already registered user name. Register the user under another name.

User accounts		Add new Account	
User Name	Account Type	Update	Delete
AAA	Administrative User	Update	Delete
BBB	Standard User	Update	Delete



## Registering, Deleting and Changing User Account Control

### ■ Changing the Registered Information

1 Click [Update] in the [User accounts].

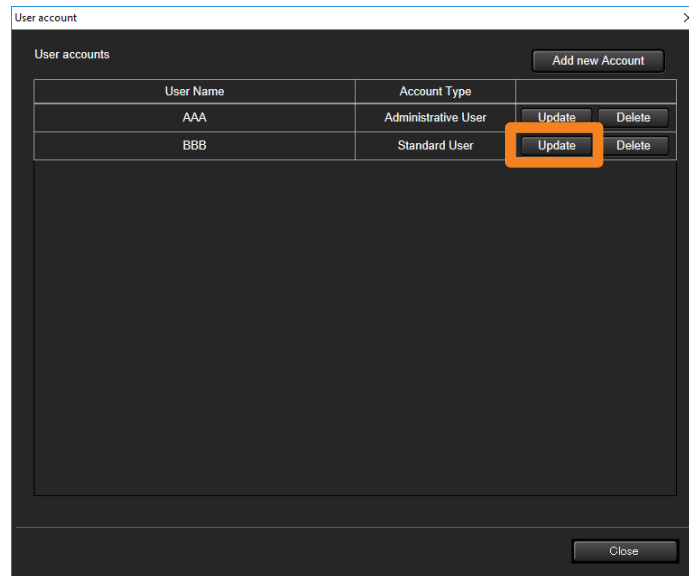

2 Change user account control.

- The [User Name] cannot be changed.
- [Password] and [Confirm Password] are not echoed to the screen.

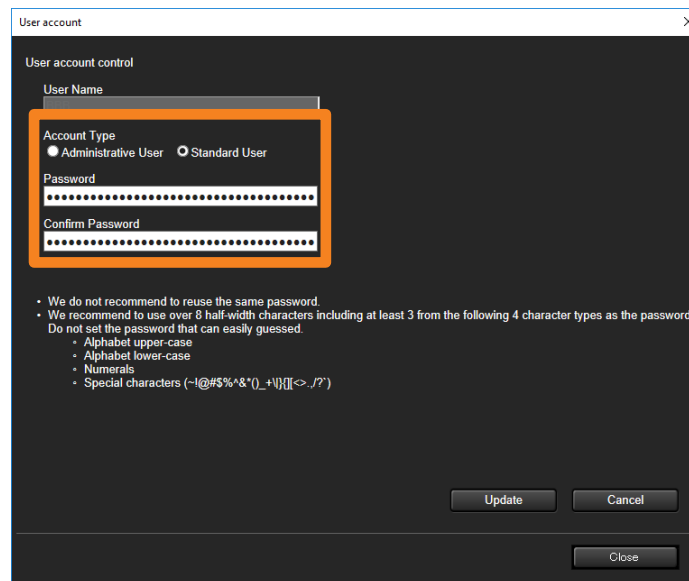

3 Click [Update].

The entered data is used for changing user account control and the user accounts screen appears again.

- Click [Cancel] if you decide not to update.

## Registering, Deleting and Changing User Account Control

### ■ Deleting a User

1 Click [Delete] in the [User accounts].

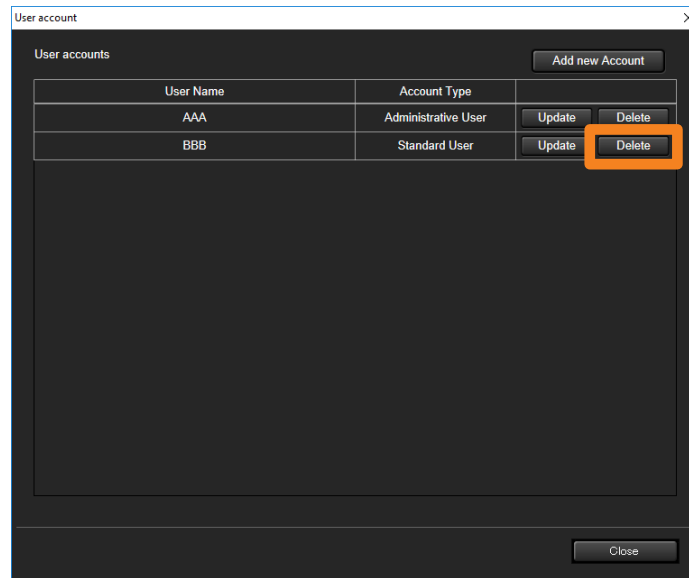

2 When the confirmation message is displayed, click [OK].

The user is now deleted from user accounts.

- Click [Cancel] if you decide not to delete.

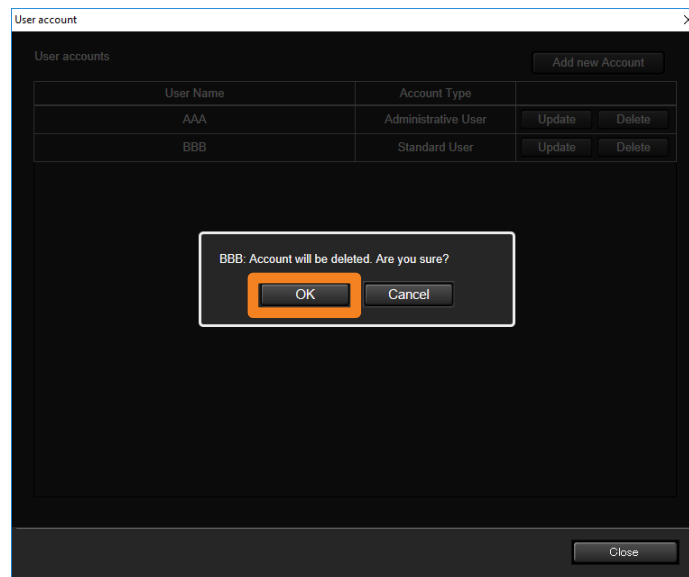

## Making Video Stop Determination Settings for a Network Camera

You can set video stop determination exception conditions for a network camera.

**1** Open the [Others] tab (page 235), and click [Video stop determination].

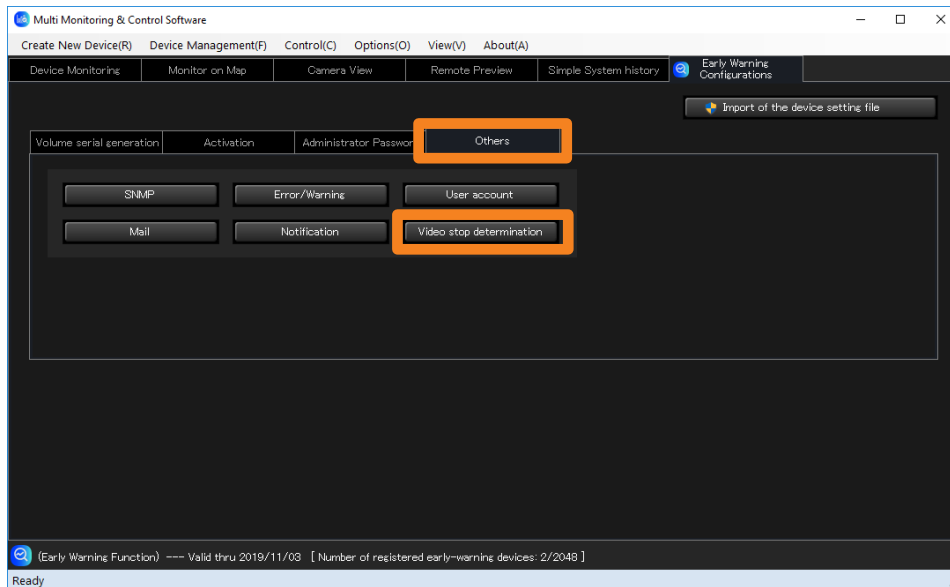

**2** Check the determination conditions you want to add.

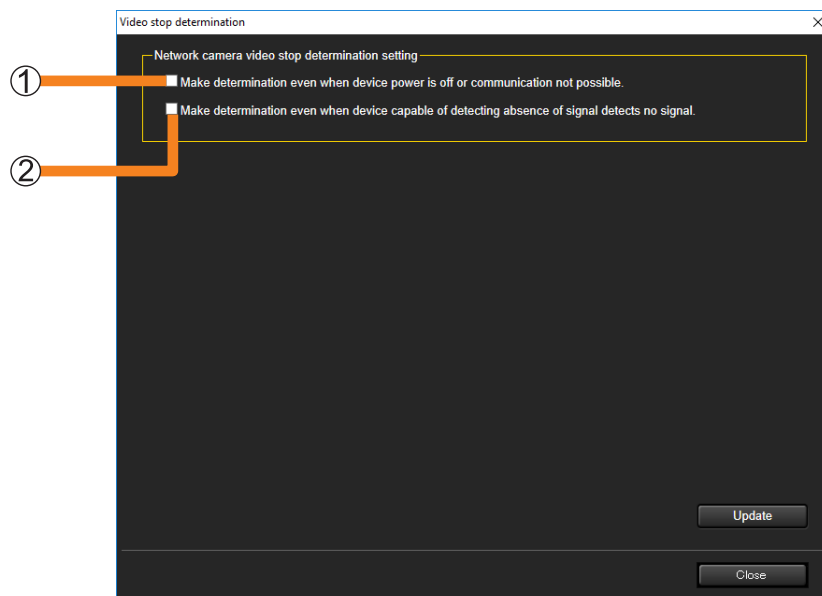

①: When you place a check, cases are also included in the determination conditions wherein the device is in the standby state (not projecting) or communication is not possible.

②: When you place a check, no-signal zones in the determination conditions for devices supporting no-signal detection are also included.

**3** Click [Update].

A message indicating that the update was successful appears. Click [OK] to update the settings.

# Other Questions & Answers

## Error Messages

### Errors relating to the multi monitoring and control functions

#### ■ Cannot register a device

Message	Remedy
Please register as a device administrator authority user.	Specify a user name and password for the administrator privileges of the device then register.
2048 devices have already been registered.	The maximum number of registered devices is 2,048. Be sure to stay within that range.
Create Device Failed. Confirm IP Address, User Name and Password.	Confirm the IP address, user name and password of the device you want to register.
Create Device Failed. Cannot connect with the projector.	Check LAN cable connection, and confirm the IP address, user name and password of the device you want to register.
Device with Same IP Address has already been registered.	Confirm the IP address of the device whose information is to be updated.
Device Update Failed. Confirm IP Address, User Name and Password.	Confirm the IP address, user name, and password that were set for the device whose information is to be updated.
Invalid IP Address. Input correct IP Address.	Confirm the IP address of the device whose information is to be updated.
Password for Administrator account is not set. Do you want to set a password?	Set the administrator account of the device to that is to be registered.

#### ■ Cannot create a group, keyword, or brightness control

Message	Remedy
100 groups have already been created.	The maximum number of groups to which devices can be registered is 100. Be sure to stay within that range.
100 keywords have already been created.	The maximum number of keywords to which devices can be registered is 100. Be sure to stay within that range.
100 Brightness Controls have already been created.	The maximum number of brightness controls to which devices can be registered is 100. Be sure to stay within that range.

## Error Messages

## ■ Interrupting delivery or content list delivery cannot be executed

Message	Remedy
Interrupt delivery failed.	Confirm the connection with the device and make sure there are no problems communicating with it.
Content list delivery failed.	Confirm the connection with the device and make sure there are no problems communicating with it. In addition, make sure the device has enough memory.
Content list copy failed.	Confirm the connection with the device and make sure there are no problems communicating with it. In addition, make sure the device has enough memory.
The PowerPoint® presentation software has not been installed.	Make sure the PowerPoint® presentation software is installed on your computer.
The PowerPoint® presentation software is running. Close the PowerPoint® presentation software, and retry.	If the PowerPoint® presentation software is already running, close it and then retry.
The contents is too large. Make sure that the contents are smaller than 2 GB.	The maximum size of the contents that can be used is 2 GB.
The file extension and the actual file format are mismatched.	See pages 139 and 155 for details about the still image and movie file formats that can be used.
It is not possible to save more than 32 GB of contents. Please delete contents.	Make sure the saved contents do not exceed 32 GB.
No USB memory drive inserted. Cancel processing.	Make sure that the USB memory drive is inserted in the device.

## Error Messages

### Failed to acquire brightness control and/or signage schedule

Message	Remedy
Confirm whether the adjustment mode of the brightness control is "PC".	Set the adjustment mode of the device's brightness control to "PC".
Please check that the adjustment mode of the brightness control is "PC", and that it is a model corresponding to the brightness control.	Set the adjustment mode of the device's brightness control to "PC". Make sure that models that do not support brightness control are excluded from the brightness control group.
If a different device model is connected with Brightness Control group, Brightness Control cannot be executed.	A device that differs from the registered device was connected to the brightness control group. Be sure to connect the correct device and exclude incorrect models from the brightness control group.
Acquisition of signage schedule failed.	Confirm the connection with the device and make sure there are no problems communicating with it.
It is not possible to save more than 32 GB of signage schedule. Please delete signage schedule.	Check the size of the signage schedule (including contents) on the device side, and delete schedule data on the device.
Insufficient free space. Please make sure there is at least 1 GB of free space.	Check the free space on your computer's hard disk.

## Errors relating to the early warning function

### Issues with licenses or user accounts

Message	Remedy
You have reached the maximum number of accounts that can be registered. It is not possible to add additional accounts.	You can only register up to 100 accounts. Be sure to stay within that range.
Duplicated user account name.	Use a user account name that is not already registered in the software.

## Error Messages

### ■ Unable to update the Device Profile Library, register a network camera, or register a DIGITAL LINK Switcher

Message	Remedy
Confirm the Device Profile Library.	Prepare the correct device profile library.
The selected library is same or older library than current one.	Prepare a device profile library that is newer than the one that is currently registered in the software.
Network Camera's IP Address is invalid.	Correctly enter the IP address of the network camera you want to register.
Network Camera's User Name is required.	No user name has been entered. Enter the user name for the network camera you want to register.
Confirm that the IP address, user name, and password of the network camera are correct.	Confirm the IP address, user name and password of the network camera you want to register.
Communication error occurred when trying to connect to Network Camera.	Check the network connection.
Can't find Network Camera.	Check the network connection.
Duplicated Network Camera.	This network camera has already been registered.
DIGITAL LINK Switcher's IP Address is invalid.	Correctly enter the IP address of the DIGITAL LINK Switcher you want to register.
DIGITAL LINK Switcher's User Name is required.	No user name has been entered. Enter the user name for the DIGITAL LINK Switcher you want to register.
Communication error occurred when trying to connect to DIGITAL LINK Switcher.	Check the network connection.
Can't find DIGITAL LINK Switcher.	Check the network connection.
Confirm IP Address, User Name and Password of DIGITAL LINK Switcher.	Confirm the IP address, user name and password of the DIGITAL LINK Switcher you want to register.
Duplicated DIGITAL LINK Switcher.	This DIGITAL LINK Switcher has already been registered.

### ■ Output stopped video detection by camera

Message	Remedy
The No Image Determination time is invalid.	Set the time to a value between 1 minute and 10 minutes.
The video stop determination setting count is already the maximum value of 32. It is not possible to add any more video stop determination settings.	The maximum number of video stop determination settings is 32. Be sure to stay within that range. The number of video stop determination settings represents the number of network cameras associated with devices.
Judgment area could not be automatically detected.	Manually set the rectangular setting of the image detection area.

## Frequently Asked Questions

Check the following points once more before requesting repair.

### A “401 Unauthorized ...” error is shown and the <Web Control> window cannot be displayed

Is there a mistake with the username entered when the device was registered?

- The username entered when device was registered to this software must be the same as the username set to display the <Web Control> window of the relevant device.

### Cannot switch input from control screen of this software

Is there a mistake with the username entered when the device was registered?

- To use the input switch button of the control screen of this software, the username entered when device was registered to this software must be the same as the username set (with administrator rights) to display the <Web Control> window of the relevant device.

### Simultaneous image distribution fails

Is the input of your device set to Miracast / MIRRORING / Signage / MEMORY VIEWER / WHITEBOARD?

- Simultaneous image distribution will fail if the input of your device is set to any of the above. Press the “Panasonic APP” button or “NETWORK/USB” button on the remote control to change the input to “Panasonic APPLICATION”, and then try the simultaneous image distribution again.

### Acquisition of information is not possible

When “INFORMATION\_ERROR” is displayed on the command execution log area of the device monitoring screen, confirm the device connection or authentication information.

### In caption distribution, the caption display is garbled at the delivered device.

It is necessary to redo the setting of the font to be used at caption editing.

- Select an applicable caption list, and after changing the font at the caption editing screen, perform caption distribution once more.

### Cannot convert from PowerPoint to still image or movie during content list delivery

Is PowerPoint running while the <Content list delivery> window is displayed?

- Quit PowerPoint, then open the <Content list delivery> window. If the problem persists after quitting PowerPoint, close the software, restart the computer, and try again.



## Frequently Asked Questions

An [An error occurred in communication with the monitoring service.] error is displayed, and the software will not launch.

Is Early Warning Software not running?

- In order to launch the software, the state of the “Early Warning Software” service must be “Running”.

1. Right-click [Start] button and select [Computer Management].

2. In [Services and Applications], select [Services], and confirm that the status of [Early Warning Software] is [Running].

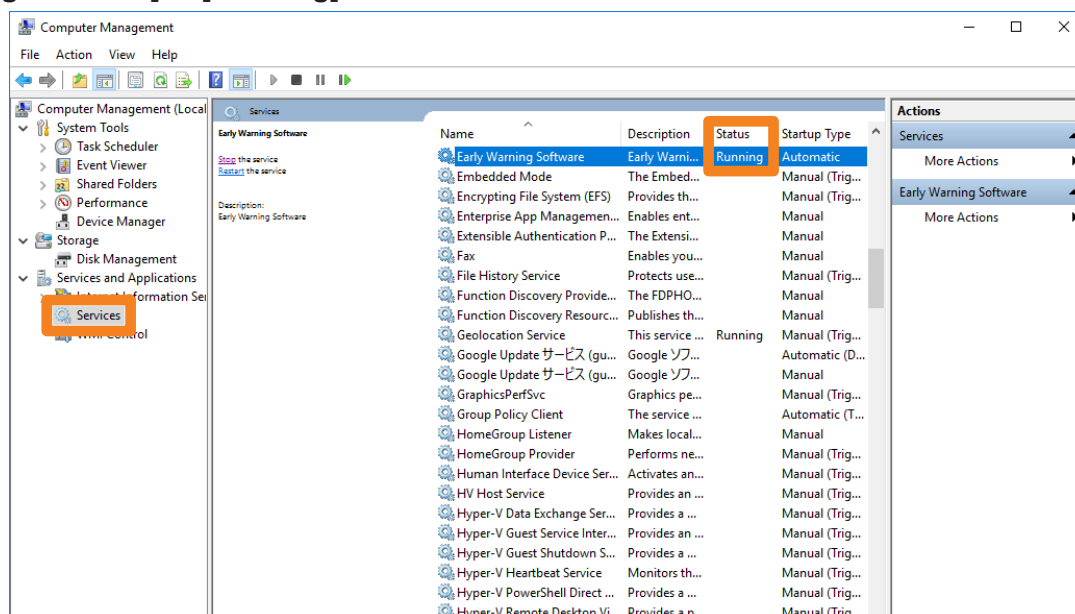

- If the status of [Early Warning Software] is not [Running], click [Early Warning Software] and select [Start the service] to start it.

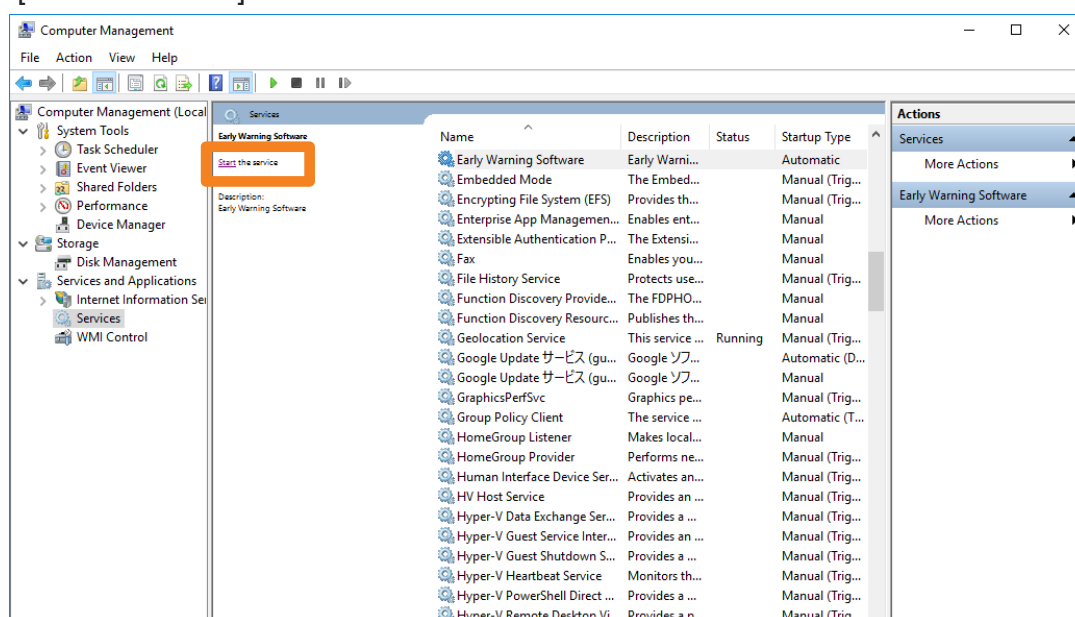

## Frequently Asked Questions

Is IIS (Internet Information Services) correctly configured?

1. Type “Control Panel” in the search bar to launch the control panel.

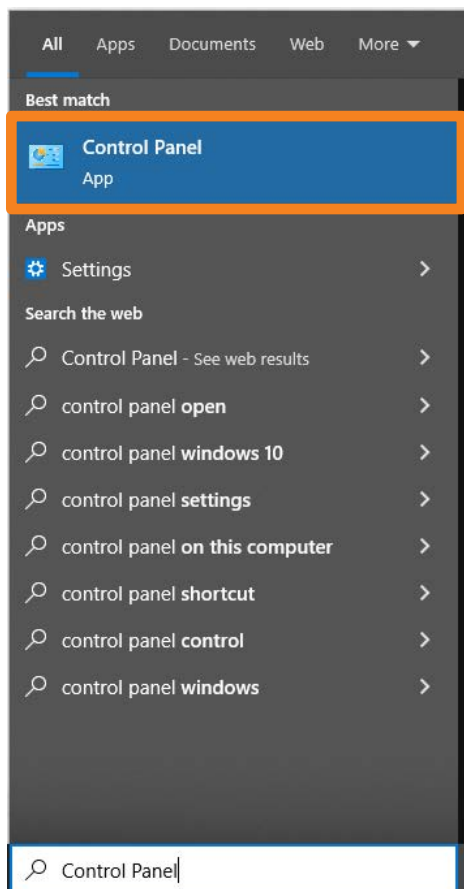

2. Select [Programs] in the Control Panel.

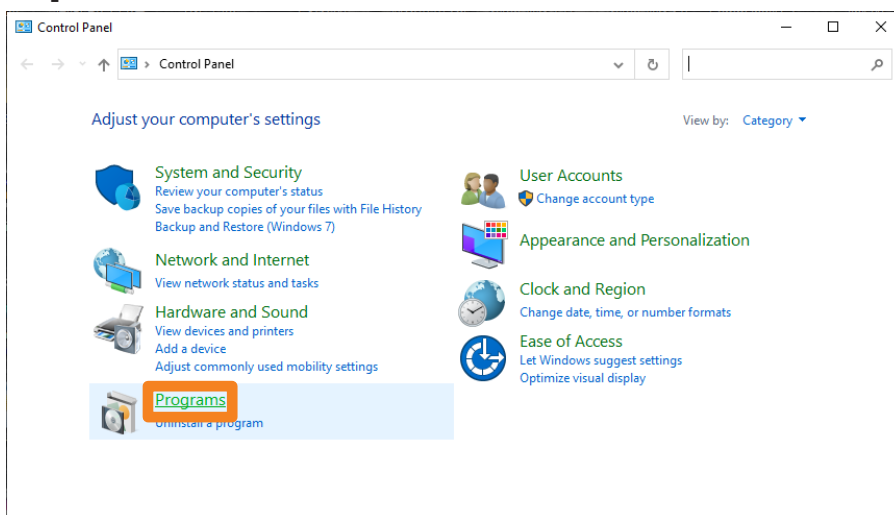

Frequently Asked Questions

3. Click [Programs and Features] → [Turn Windows features on or off].

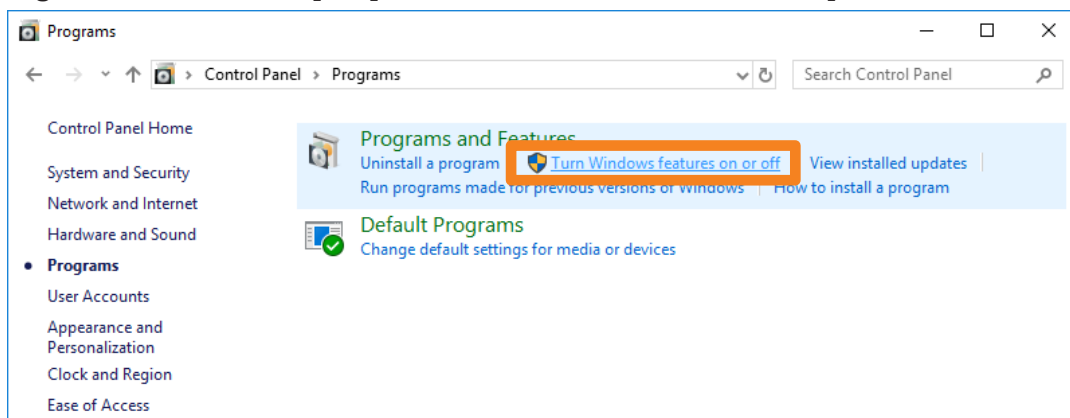

4. For the following three functions, confirm that the settings for each item are as shown below, then click [OK].

[.NET Framework 4.7 Advanced Services]

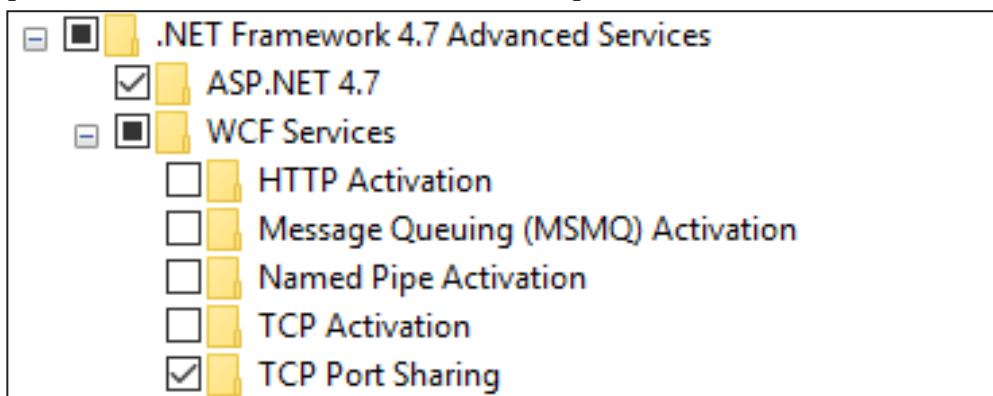

[Windows Process Activation Service]

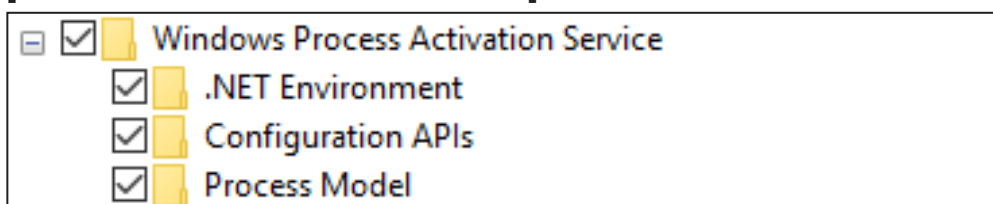

## Frequently Asked Questions

## [Internet Information Services]

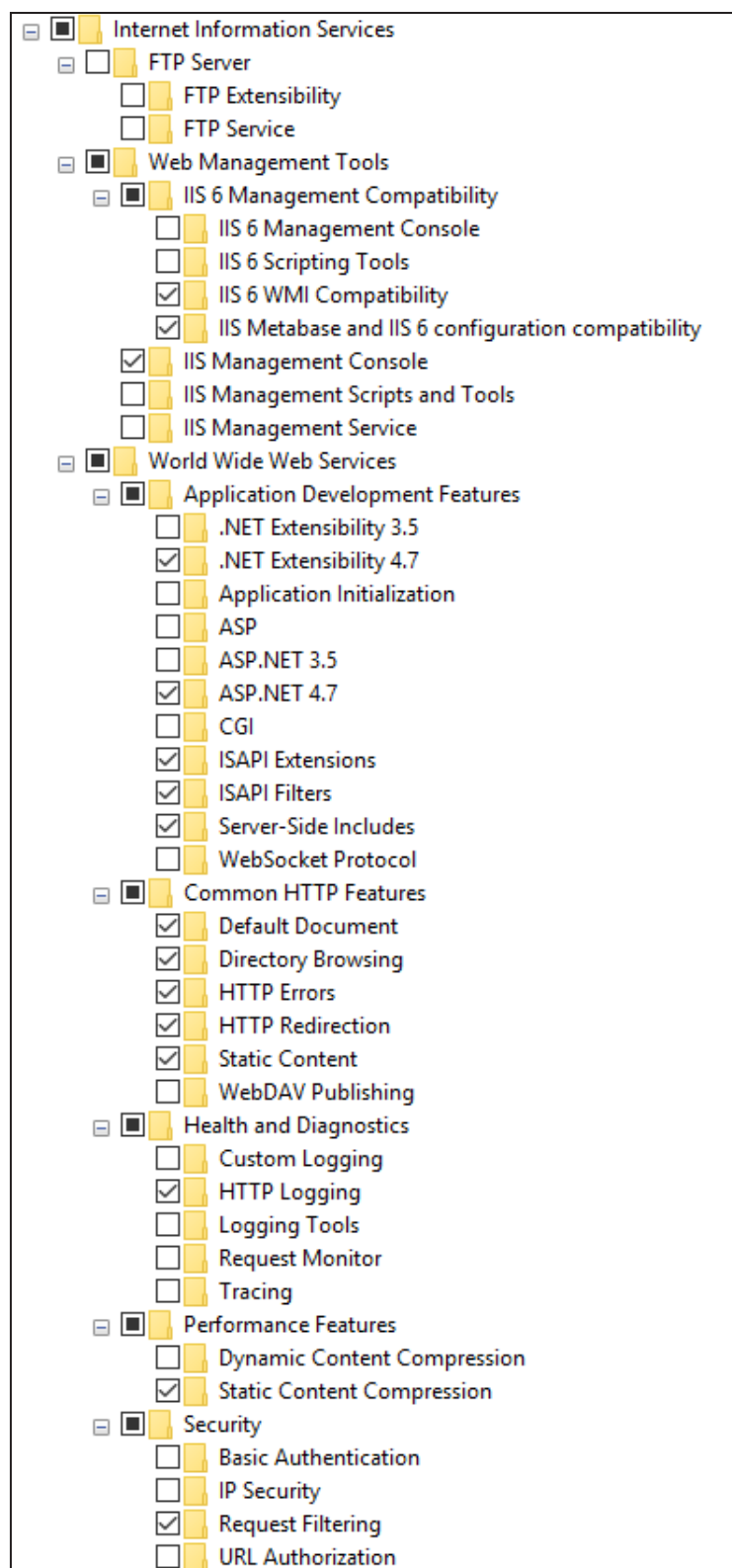

## Frequently Asked Questions

## Cannot install the software

Is Microsoft .NET Framework 4.7 installed on your computer?

- To install the software, you first have to install Microsoft .NET Framework 4.7 on your computer.

1. Type “Control Panel” in the search bar to launch the control panel.

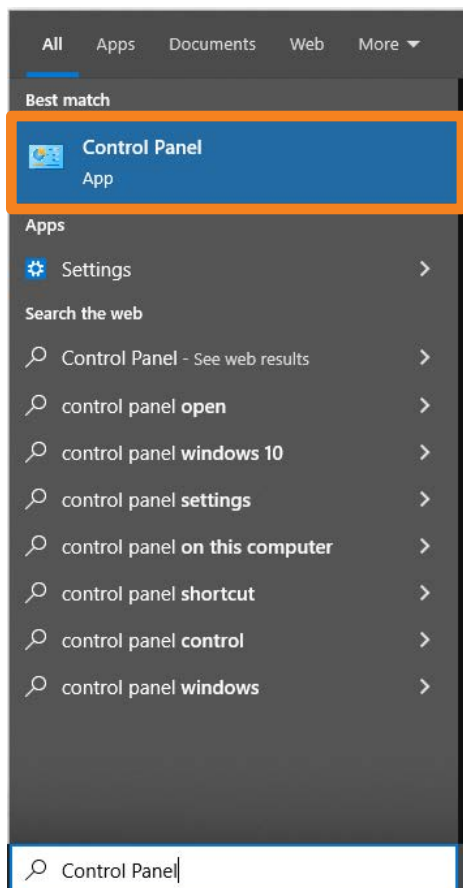

2. Select [Programs] in the Control Panel.

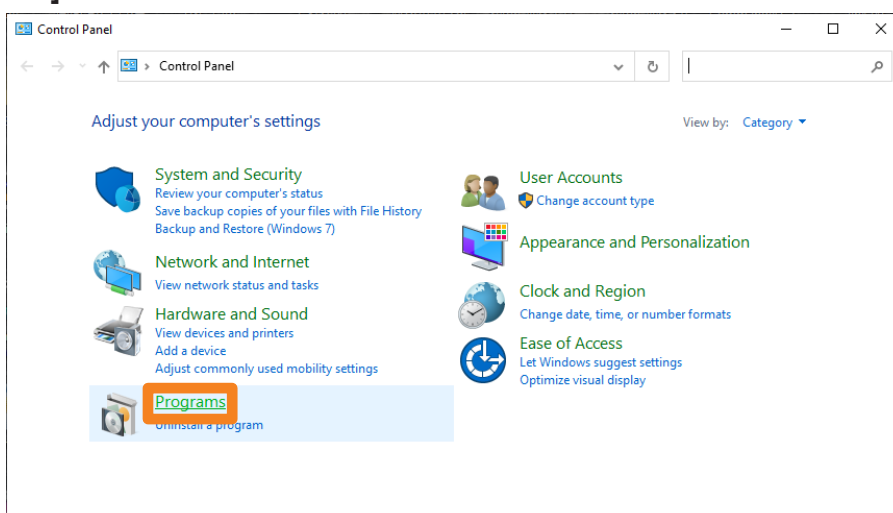

## Frequently Asked Questions

3. Click [Programs and Features] → [Turn Windows features on or off].

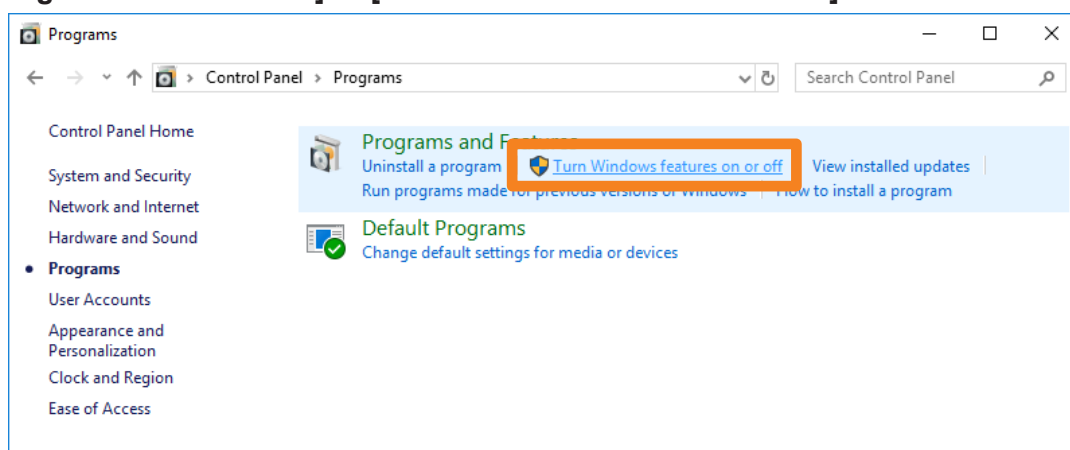

4. Select the “.NET Framework 4.7 Advanced Services” check box and click [OK].

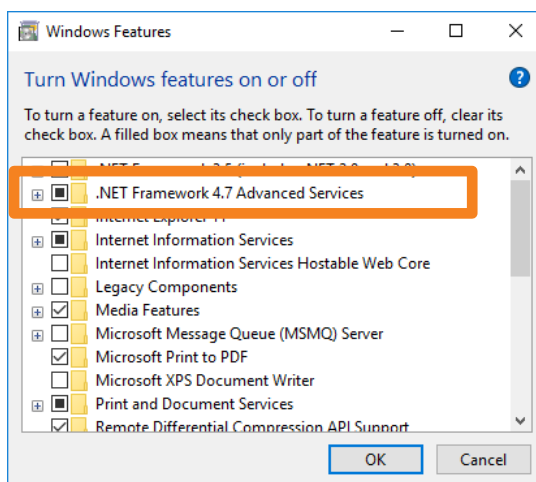

5. The required files are located and Microsoft .NET Framework 4.7 is installed.

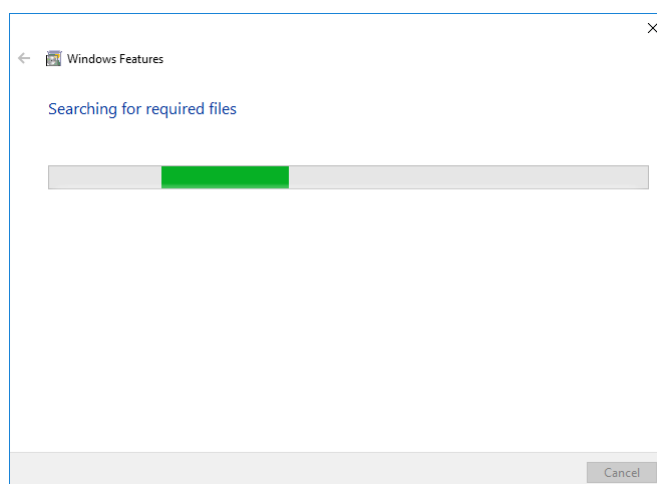

## Frequently Asked Questions

6. If the files required for installing Microsoft .NET Framework 4.7 are not on your computer, a screen like the one shown below appears. Select [Let Windows Update download the files for you] in that screen. (This process requires an Internet connection.)

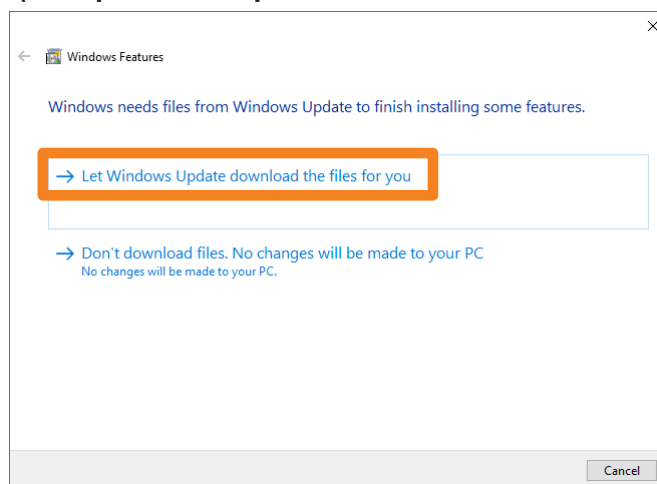

7. Restart the computer when installation completes.

**Messages that appear when an attempt to uninstall or update the software is made**

Is the “Warning 1910.Could not remove ...” message displayed?

- If an NVIDIA driver is installed on your computer, the following message may appear.

-----  
Warning 1910. Could not remove shortcut Multi Monitoring & Control Software.lnk.  
Verify that the shortcut file exists and that you can access it.  
-----

Click [OK] to continue an uninstall or update procedure.

Although uninstalling the software will also remove the desktop shortcut icons, please manually delete the shortcut icons when you start up the computer next time as they will be regenerated.

## Frequently Asked Questions

## No connection can be made between my device and my computer

## When Windows Firewall has been detected

Is the firewall exception setting turned on?

1. Type “Control Panel” in the search bar to launch the control panel.
2. Select [System and Security] in the Control Panel.

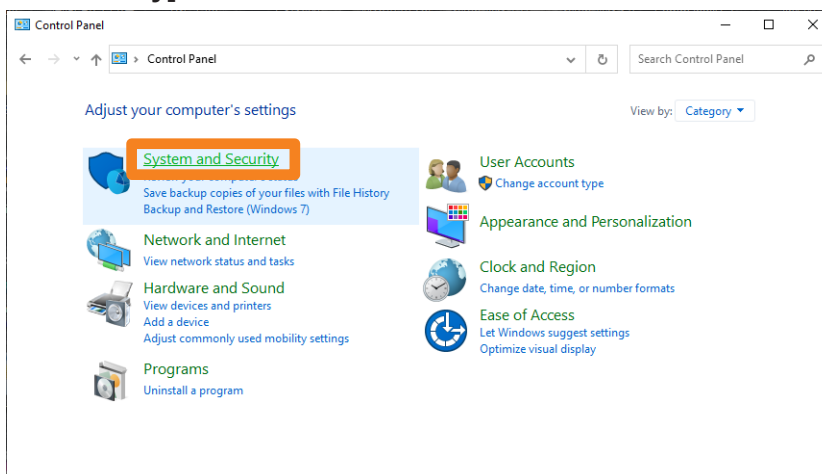

3. Click [System and Security] → [Windows Defender Firewall] → [Allow an app through Windows Firewall].

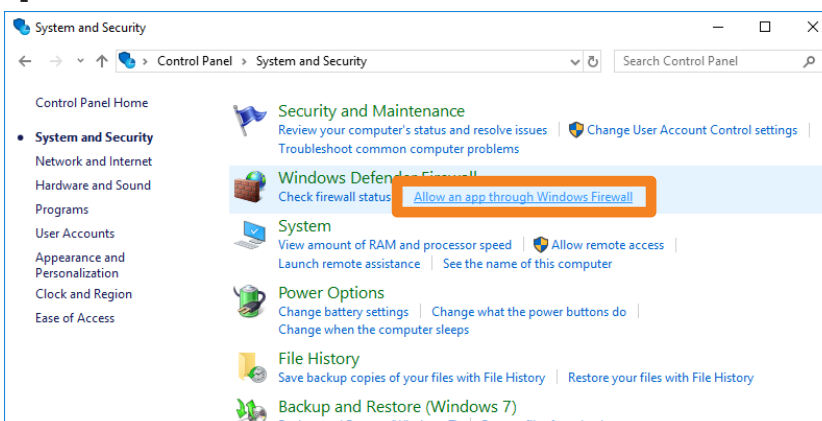



Frequently Asked Questions

4. Click [Change Settings] (①) → [Allow another app] (②).

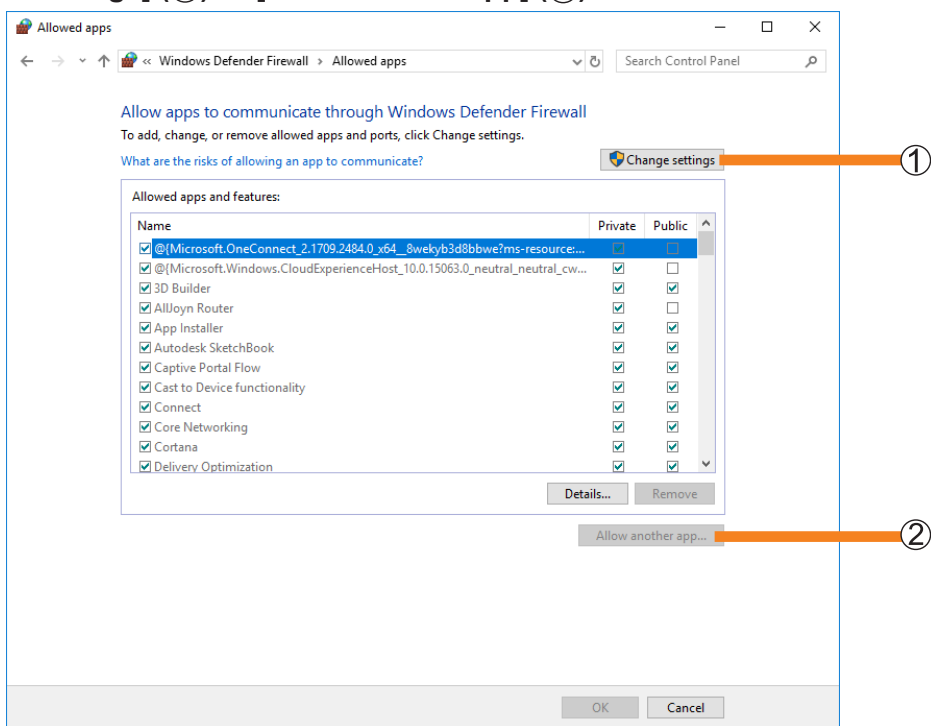

5. Click [Browse] (③).

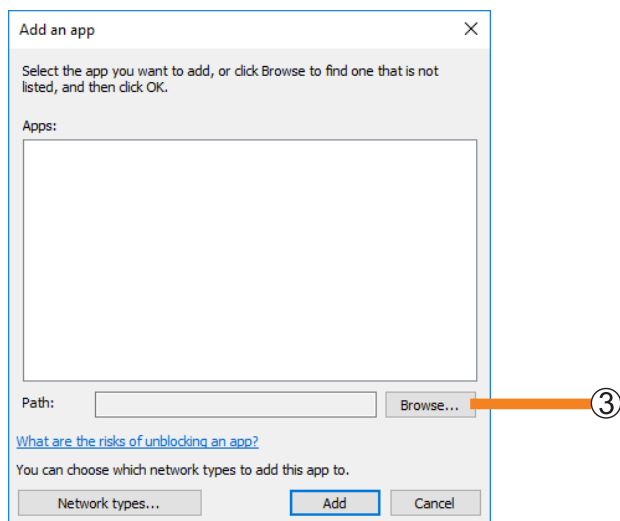

## Frequently Asked Questions

**6. Select [PJMC.exe] and click [Open] (④).**

If you do not specify a different destination, the software is installed in the following location.  
C:\Program Files (x86)\Panasonic\Early Warning Software

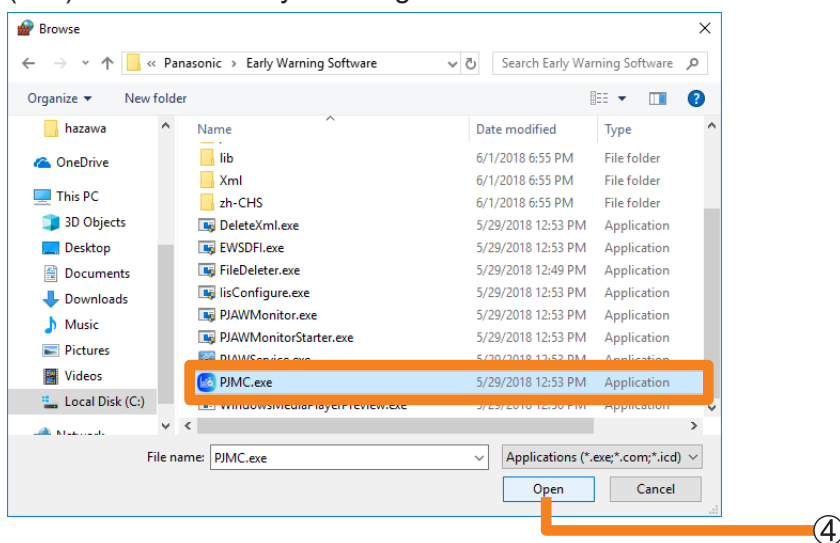
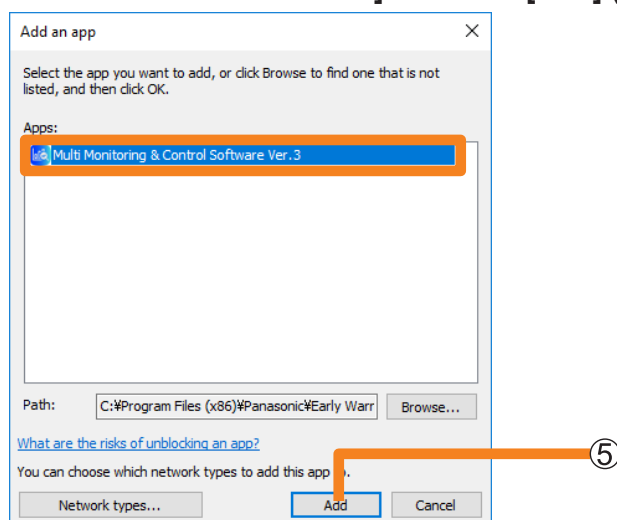
**7. Select [Multi Monitoring & Control Software Ver.XX] and click [Add] (⑤).**

## Frequently Asked Questions

8. Select the [Private] or [Public] network you want to allow connection to and click to select the check box.

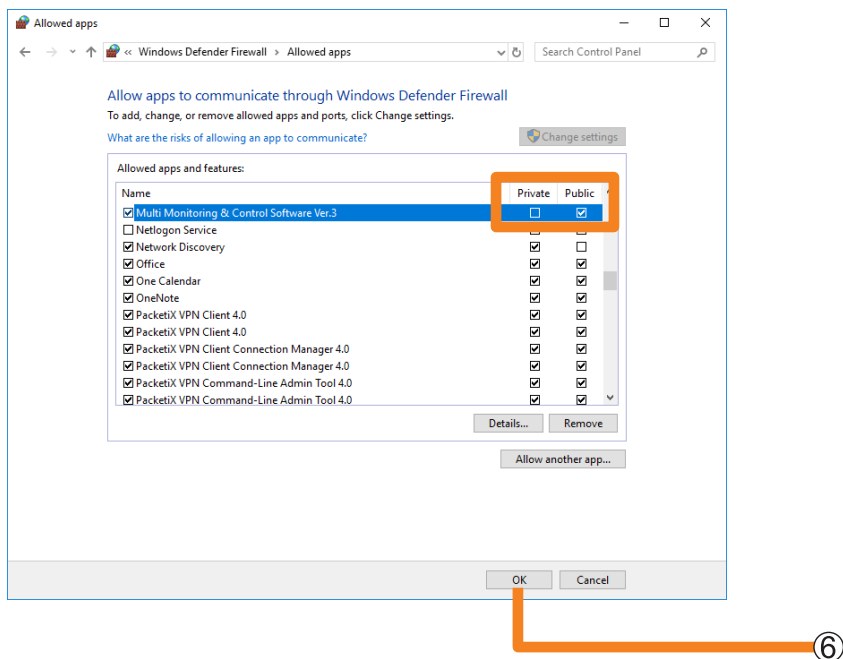

9. Click [OK] (6).

This software will now be added to the Windows Defender firewall's exception list.

### When another firewall has been detected

Are any firewall-containing applications installed?

- If any applications which contain firewalls are installed, the installation may not complete. (The firewall function may activate without launch of the application if the application has already been installed.)  
If this occurs, firewall settings must be changed in order to allow connection to the network.
- See the User's Manuals for all applications containing firewalls to perform these settings.

### When the software is launched, an error occurs in communication with the monitoring service.

The following message is displayed if the required data cannot be read when the software is launched:

-----  
 An error occurred in communication with the monitoring service.  
 Since there is a possibility that the monitoring service may be stopped, restart the PC.  
 -----

- Restart the computer, then launch the software again.  
If the same error occurs after restarting the computer, it is possible that the required data has become corrupt.  
Reinstall the software.

### Frequently Asked Questions

---

#### **The screen is not displayed even when calling up the device's WEB control function.**

If the device or network camera being used is set to connect using HTTPS communication or if it is required to install a plug-in software, the WEB control screen may not be displayed even if you call up the device's WEB control function from this software.

- When the WEB control screen is not being displayed, enter the IP address of the device or network camera into the WEB browser URL input field and directly open the WEB control screen.

## Trademarks

- Microsoft, Windows, Excel, PowerPoint and Microsoft Edge are either registered trademarks or trademarks of Microsoft Corporation in the United States and/or other countries.
- PJLink™ is a registered trademark or pending trademark in Japan, the United States, and other countries and regions.
- Intel is a registered trademark or trademark of Intel Corporation or its subsidiaries in the United States and/or other countries.
- DisplayPort is a trademark of the Video Electronics Standards Association.
- Android and Google Chrome are trademarks of Google LLC.
- iPad, iPhone, iPadOS and Safari are trademarks of Apple Inc., registered in the U.S. and other countries.
- IOS is a trademark or registered trademark of Cisco in the U.S. and other countries and is used under license.
- Other company names, product names or other names noted in these operating instructions are trademarks or registered trademarks of the respective companies. Note that ® and TM marks are not indicated in these operating instructions.

**Notes:**

- Unauthorized use or reproduction of part or all of this software and manuals is strictly prohibited.
- Panasonic Connect Co., Ltd. cannot be held liable for any effects resulting from the use of this software and manuals.
- Panasonic Connect Co., Ltd. reserves the right to revise this software specifications and manual contents without notice.

---

# Panasonic Connect Co., Ltd.

Web Site : <https://panasonic.net/cns/projector/>  
<https://panasonic.net/cns/prodisplays/>

© Panasonic Connect Co., Ltd. 2024

W0524KZ0 -PB